

**RURAL DRINKING WATER AND SANITATION DEPARTMENT
GOVERNMENT OF KARNATAKA**

REQUEST FOR BIDS NO1

**NATIONAL OPEN COMPETITIVE PROCUREMENT
(Two-Envelope Bidding Process with e-Procurement)
FOR
CONSTRUCTION OF MATERIAL RECOVERY FACILITY AT HEBRI GRAM
PANCHAYATH, HEBRITALUK,UDUPI DISTRICT
(UPGRADINGFROM 5 TPD TO 7 TPD)
UNDER KARNATAKA STRENGTHENING COASTAL RESILIENCE AND THE
ECONOMY (K-SHORE)-P180932**

RFB Reference No.	IN-KERS-458926-CW-RFB
Period of Bidding Document	From 09.11.2024 to 09.12.2024
Last date for submitting queries (on or before)	25.11.2024 at 1600 hours IST
Time & Date of Pre-Bid Meeting	13.11.2024 at 1100 Hours IST
Last Date and Time for Receipt of Bids	09.12.2024 at 1600 Hours IST
Period of Sale of Bidding Document	09.11.2024 to 09.12.2024 (1600 hours IST)
Time and Date of Opening of Bids (Technical Part)	10.12.2024 at 1630 Hours IST
Place of Opening of Bids	Opened online on Karnataka Public Procurement Portal (kppp.karnataka.gov.in) in the O/o of Executive Engineer of Udupi Division, Rural Drinking Water and Sanitation Department (RDWSD).
Place of Inviting Bids	Office of Executive Engineer, Udupi Division, Rural Drinking Water and SanitationDepartment (RDWSD), B 208, B Block, Rajathadri, DC Office Complex, Manipal, Udupi576104 Udupi District, Karnataka, India. Phone: 0820 2574942 Email ID: eerdwsd.udp@gmail.com

November2024

REQUEST FOR BIDS

(RFB)

**GOVERNMENT OF KARNATAKA
K-SHORE PROJECT**

**REQUEST FOR BIDS (RFB)
E-Procurement Notice
(Two-Envelope Bidding Process with e-Procurement)**

NATIONAL OPEN COMPETITIVE PROCUREMENT

Name of Project: Karnataka Strengthening Coastal Resilience and the Economy (K-SHORE)-P180932

Contract Title: Construction of Material Recovery Facility At Hebri Gram Panchayath, Hebri Taluk, Udupi District (Upgrading from 5 TPD to 7 TPD) Under Karnataka Strengthening Coastal Resilience And The Economy (K-Shore)-P180932

Loan No.: To be assigned

RFB Reference No.: IN-KERS-458926-CW-RFB

Date: 09th November 2024

1. The Government of India has applied for financing from the International Bank for Reconstruction and Development (IBRD) (the “Bank”) toward the cost of the Karnataka Strengthening Coastal Resilience And the Economy (K-SHORE) Project and it is intended that part of the proceeds will be applied to eligible payments under the contract for **Construction of Material Recovery Facility at Hebri Gram Panchayath, Hebri Taluk, Udupi District (upgrading from 5 TPD to 7 TPD)**, in the state of Karnataka.
2. Bidding will be conducted through national open competitive procurement using a Request for Bids (RFB) as specified in the World Bank’s “Procurement Regulations for IPF Borrowers, Sept 2023,” (“Procurement Regulations”), and is open to all Bidders as defined in the Procurement Regulations.
3. Bidders from India should, however, be registered with the Government of Karnataka or other State Governments/ Government of India, or State/ Central Government Undertakings. Bidders are required to register on the Karnataka Public Procurement Portal (<https://kppp.karnataka.gov.in>) and obtain a valid Digital Signature Certificate (DSC) to submit their bids.
4. The Office of the Executive Engineer, Udupi Division, Rural Drinking Water and Sanitation Department District, Udupi, now invites online Bids from eligible Bidders for the construction of works detailed below in the table. The bidders may submit bids for any or all the works indicated therein. Interested bidders may obtain further information and inspect the bidding document at the address given below during office hours. Bidders are advised to note the clauses on eligibility (Section I Clause 4) and minimum qualification criteria (Section III – Evaluation and Qualification Criteria), to qualify for the award of the contract. In addition, please refer to paragraphs 3.14 and 3.15 of the “Procurement Regulations” setting forth the World Bank’s policy on conflict of interest.

-
5. The bidding document is available online on [Karnataka Public Procurement Portal, Government of Karnataka's e-procurement Portal \(kppp.karnataka.gov.in\)](http://karnataka.gov.in) hereafter referred as KPPP, **from 09.11.2024 to 09.12.2024** for a non-refundable fee as indicated in KPPP only. Bidders will be required to register on the KPPP. The bidders would be responsible for ensuring that any addenda available on the KPPP is also downloaded and incorporated.
6. For submission of the bid, the bidder is required to have Digital Signature Certificate (DSC) from one of the Certifying Authorities authorised by Government of Karnataka for issuing DSC. Aspiring bidders who have not obtained the user ID and password for participating in e-procurement for this Project, may obtain the same by registering with Karnataka Public Procurement Portal and have Digital Signature Certificate (DSC) from the concerned Authority. This e-procurement system shall be used to manage the following.
- Issuing of Request for Bid (RfB)
 - Submission of Technical Proposal
 - Opening of Proposals (Technical)
 - Submission of queries/clarification by bidders
 - Acceptance/confirmation of proposal

A non-refundable fee as mentioned in KPPP e-procurement portal is required to be paid to participate in the bid process. The mode of payment shall be through the e-procurement portal.

7. Bids comprise two Parts, namely the Technical Part and the Financial Part, and both parts must be submitted simultaneously online on [KPPP Portal \(karnataka.gov.in\)](http://karnataka.gov.in) on or before 1600 hours IST **on 09.12.2024** and the 'Technical Part' of the bids will be publicly opened online on **the 10.12.2024 at 1630 hours IST**, through KPPP. Any bid or modifications to bid received **outside e-procurement** system will not be considered. If the office happens to be closed on the date of opening of the bids as specified, the bids will be opened on the next working day at the same time. The electronic bidding system would not allow any late submission of bids.
8. All Bids must be accompanied by a Bid Security of the amount specified for the works in the **Error! Reference source not found.**, payable online only through KPPP and shall have to be valid for 45 days beyond the validity of the bid. The submission of bid security is described in Para 9.
9. The requisite Bid Security shall be paid in e-Payment as specified in e-Procurement portal using any of the following payments modes.
- Credit card.
 - Direct debit
 - National Electronic Fund Transfer (NEFT).
- The bidders will be evaluated on confirming of receipt of the payment (bid security) in the Government of Karnataka Central pooling Account.
 - The entire bid security for a particular tender has to be paid in a single transaction. It is responsibility of Bidders to ensure that payment through NEFT reaches GoK Bank before Bid submission date and time, through online payment.
10. A pre-bid **meeting will be held on 13.11.2024 at 1100 hours** at the office of **Executive Engineer, Udupi Division, RDWSD, Udupi, Udupi District, Karnataka, India**, to clarify the issues and to answer questions on any matter that may be raised at that stage as stated in

ITB Clause 7.4 of ‘Instructions to Bidders’ of the bidding document. Bidders are advised to download the bidding document prior to the pre-bid meeting in order for bidders to have a good understanding of the scope of work under this contract for discussion and clarification at the pre-bid meeting.

11. Other details can be seen in the bidding document. The Employer shall not be held liable for any delays due to system failure beyond its control. Even though the system will attempt to notify the bidders of any bid updates, the Employer shall not be liable for any information not received by the bidder. It is the bidders’ responsibility to verify the website for the latest information related to this bid.

12. The address for communication is as under:

Executive Engineer, Udupi Division, Rural Drinking Water and Sanitation Department (RDWSD), B 208, B Block, Rajathadri, DC Office Complex, Manipal, Udupi 576104
Udupi District, Karnataka, India.

Phone: 0820 2574942

Email ID: eerdwsd.udp@gmail.com

Table 1: Work Details

Work No.	Name of Work	Estimated Amount excluding GST (INR in lakh)	Bid Security (In INR.)	Cost of Document (In INR.)	Period of Completion
1	2		3	4	5
I	Construction of Material Recovery Facility (MRF) at Hebri Gram Panchayat, Hebri Taluk, Udupi District, Karnataka (upgrading from 5 TPD to 7 TPD). The main civil components a) Pre-Engineered Building (PEB) shed of 25 m*15 m with 7.5m clear height b) Building – security room, weighbridge room, toilets, changing rooms, weighbridge office, office c) plumbing works for water supply. d) Rainwater harvesting unit e) Fire hydrant pump room f) CC road	136.21	2,72,500.00	As generated by KPP portal	11 Months (including monsoon)

(Seal and signature of office)

Executive Engineer, Udupi Division, Rural Drinking Water and Sanitation Department (RDWSD), B 208, B Block, Rajathadri, DC Office Complex, Manipal, Udupi 576104

Udupi District, Karnataka, India.
Phone: 0820 2574942
Email ID: eerdwsd.udp@gmail.com

Table of Contents

PART 1 – Bidding Procedures	7
Section I - Instructions to Bidders	8
Section II - Bid Data Sheet (BDS)	35
Section III - Evaluation and Qualification Criteria	41
Section IV - Bidding Forms	61
Section V - Eligible Countries	101
Section VI - Fraud and Corruption.....	102
PART 2 – Works’ Requirements	104
Section VII - Works’ Requirements.....	167
PART 3 – Conditions of Contract and Contract Forms	110
Section VIII - General Conditions of Contract	111
Section IX - Particular Conditions of Contract.....	144
Section X - Contract Forms	261

PART 1 – Bidding Procedures

Section I - Instructions to Bidders

A. General	
1. Scope of Bid	<p>1.1 In connection with the Specific Procurement Notice - Request for Bids (RFB), specified in the Bid Data Sheet (BDS), the Employer, as specified in the BDS, issues this bidding document for the provision of Works as specified in Section VII, Works' Requirements. The name, identification and number of lots (contracts) of this RFB are specified in the BDS.</p>
	<p>1.2 Throughout this bidding document:</p> <ul style="list-style-type: none"> (a) the term "in writing" means communicated in written form (e.g. by mail, e-mail, and fax, including if specified in the BDS, distributed or received through the electronic-procurement system used by the Employer) with proof of receipt; (b) if the context so requires, "singular" means "plural" and vice versa; (c) "Day" means calendar day, unless otherwise specified as "Business Day". A Business Day is any day that is a working day of the Borrower. It excludes the Borrower's official public holidays; (d) the term "ES" means environmental and social (including Sexual Exploitation, and Abuse (SEA), and Sexual Harassment (SH)); (e) "Sexual Exploitation and Abuse" "(SEA)" means the following: <ul style="list-style-type: none"> (i) "Sexual Exploitation" is defined as any actual or attempted abuse of position of vulnerability, differential power or trust, for sexual purposes, including, but not limited to, profiting monetarily, socially or politically from the sexual exploitation of another. (ii) "Sexual Abuse" is defined as the actual or threatened physical intrusion of a sexual nature, whether by force or under unequal or coercive conditions; (f) "Sexual Harassment" "(SH)" is defined as unwelcome sexual advances, requests for sexual favors, and other verbal or physical conduct of a sexual nature by the Contractor's

	<p>Personnel with other Contractor's or Employer's Personnel;</p> <p>(g) "Contractor's Personnel" is as defined in Sub-Clause 1 (ii) of the General Conditions of Contract; and</p> <p>(h) "Employer's personnel" is as defined in GCC Sub-Clause 1 (nn) of the General Conditions of Contract.</p> <p>A non-exhaustive list of (i) behaviors which constitute SEA and (ii) behaviors which constitute SH is attached to the Code of Conduct form in Section IV.</p>
<p>2. Source of Funds</p>	<p>2.1 The Borrower or Recipient (hereinafter called "Borrower") specified in the BDS has received or has applied for financing (hereinafter called "funds") from the International Bank for Reconstruction and Development or the International Development Association (hereinafter called "the Bank") in an amount specified in the BDS, toward the project named in the BDS. The Borrower intends to apply a portion of the funds to eligible payments under the contract(s) for which this bidding document is issued.</p>
	<p>2.2 Payment by the Bank will be made only at the request of the Borrower and upon approval by the Bank, and will be subject, in all respects, to the terms and conditions of the Loan (or other financing) Agreement. The Loan (or other financing) Agreement prohibits a withdrawal from the loan account for the purpose of any payment to persons or entities, or for any import of goods, equipment, plant, or materials, if such payment or import is prohibited by a decision of the United Nations Security Council taken under Chapter VII of the Charter of the United Nations. No party other than the Borrower shall derive any rights from the Loan (or other financing) Agreement or have any claim to the proceeds of the Loan (or other financing).</p>
<p>3. Fraud and Corruption</p>	<p>3.1 The Bank requires compliance with the Bank's Anti-Corruption Guidelines and its prevailing sanctions policies and procedures as set forth in the WBG's Sanctions Framework, as set forth in Section VI.</p> <p>3.2 In further pursuance of this policy, bidders shall permit and shall cause their agents (whether declared or not), subcontractors, sub-consultants, service providers, suppliers, and personnel, to permit the Bank to inspect all accounts, records and other documents relating to any initial selection process, prequalification process, bid submission, proposal submission, and contract performance (in the case of award), and to have them audited by auditors appointed by the Bank.</p>

<p>4. Eligible Bidders</p>	<p>4.1 A Bidder may be a firm that is a private entity, or a state-owned enterprise or institution subject to ITB 4.6, or any combination of them in the form of a joint venture (JV), under an existing agreement, or with the intent to enter into such an agreement supported by a letter of intent, unless otherwise specified in the BDS. In the case of a joint venture, all members shall be jointly and severally liable for the execution of the entire Contract in accordance with the Contract terms. The JV shall nominate a Representative who shall have the authority to conduct all business for and on behalf of any and all the members of the JV during the Bidding process and, in the event the JV is awarded the Contract, during contract execution. This authorization shall be evidenced by submitting a power of attorney signed by legally authorized signatories of all members. Unless specified in the BDS, there is no limit on the number of members in a JV. The joint venture agreement shall be registered in the place specified in BDS so as to be legally valid and binding on members.</p>
	<p>4.2 A Bidder shall not have a conflict of interest. All Bidders found to have a conflict of interest shall be disqualified. A Bidder may be considered to have a conflict of interest for the purpose of this Bidding process, if the Bidder:</p> <ul style="list-style-type: none"> (a) directly or indirectly controls, is controlled by or is under common control with another Bidder; or (b) receives or has received any direct or indirect subsidy from another Bidder; or (c) has the same legal representative as another Bidder; or (d) has a relationship with another Bidder, directly or through common third parties, that puts it in a position to influence the Bid of another Bidder, or influence the decisions of the Employer regarding this bidding process; or (e) any of its affiliates participated as a consultant in the preparation of the design or technical specifications of the works that are the subject of the Bid; or (f) any of its affiliates has been hired (or is proposed to be hired) by the Employer or Borrower as Project Manager (Engineer) for the Contract implementation; (g) would be providing goods, works, or non-consulting services resulting from or directly related to consulting services for the preparation or implementation of the project specified in the BDS ITB 2.1 that it provided or were provided by any affiliate that directly or indirectly

	<p>controls, is controlled by, or is under common control with that firm;</p> <p>(h) has a close business or family relationship with a professional staff of the Borrower (or of the project implementing agency, or of a recipient of a part of the loan) who: (i) are directly or indirectly involved in the preparation of the bidding document or specifications of the contract, and/or the Bid evaluation process of such contract; or (ii) would be involved in the implementation or supervision of such contract unless the conflict stemming from such relationship has been resolved in a manner acceptable to the Bank throughout the procurement process and execution of the contract.</p>
	<p>4.3 A firm that is a Bidder (either individually or as a JV member) shall not participate in more than one Bid, except for permitted alternative Bids. This includes participation as a Subcontractor in other Bids. Such participation shall result in the disqualification of all Bids in which the firm is involved. A firm that is not a Bidder or a JV member may participate as a subcontractor in more than one Bid.</p>
	<p>4.4 A Bidder may have the nationality of any country, subject to the restrictions pursuant to ITB 4.8. A Bidder shall be deemed to have the nationality of a country if the Bidder is constituted, incorporated or registered in and operates in conformity with the provisions of the laws of that country, as evidenced by its articles of incorporation (or equivalent documents of constitution or association) and its registration documents, as the case may be. This criterion also shall apply to the determination of the nationality of proposed subcontractors or sub-consultants for any part of the Contract including related Services.</p>
	<p>4.5 A Bidder that has been sanctioned by the Bank, pursuant to the Bank's Anti-Corruption Guidelines, in accordance with its prevailing sanctions policies and procedures as set forth in the WBG's Sanctions Framework as described in Section VI paragraph 2.2 d., shall be ineligible to be prequalified for, initially selected for, bid for, propose for, or be awarded a Bank-financed contract or benefit from a Bank-financed contract, financially or otherwise, during such period of time as the Bank shall have determined. The list of debarred firms and individuals is available at the electronic address specified in the BDS.</p>
	<p>4.6 Bidders that are state-owned enterprises or institutions in the Employer's Country may be eligible to compete and be awarded a Contract(s) only if they can establish, in a manner acceptable to the Bank, that they (i) are legally and financially autonomous (ii)</p>

	operate under commercial law, and (iii) are not under supervision of the Employer.
	4.7 A Bidder shall not be under suspension from Bidding by the Employer as the result of the operation of a Bid-Securing or Proposal-Securing Declaration.
	<p>4.8 Firms and individuals may be ineligible if so indicated in Section V and (a) as a matter of law or official regulations, the Borrower's country prohibits commercial relations with that country, provided that the Bank is satisfied that such exclusion does not preclude effective competition for the supply of goods or the contracting of works or services required; or (b) by an act of compliance with a decision of the United Nations Security Council taken under Chapter VII of the Charter of the United Nations, the Borrower's country prohibits any import of goods or contracting of works or services from that country, or any payments to any country, person, or entity in that country. When the Works are implemented across jurisdictional boundaries (and more than one country is a Borrower, and is involved in the procurement), then exclusion of a firm or individual on the basis of ITB 4.8 (a) above by any country may be applied to that procurement across other countries involved, if the Bank and the Borrowers involved in the procurement agree.</p> <p>4.9 A Bidder shall provide such documentary evidence of eligibility satisfactory to the Employer, as the Employer shall reasonably request.</p>
5. Eligible Materials, Equipment and Services	5.1 The materials, equipment and services to be supplied under the Contract and financed by the Bank may have their origin in any country subject to the restrictions specified in Section V, Eligible Countries, and all expenditures under the Contract will not contravene such restrictions. At the Employer's request, Bidders may be required to provide evidence of the origin of materials, equipment and services.
B. Contents of Bidding Document	

<p>6. Sections of Bidding Document</p>	<p>6.1 The bidding document consists of Parts 1, 2, and 3, which include all the sections specified below, and which should be read in conjunction with any Addenda issued in accordance with ITB 8.</p> <p>PART 1 Bidding Procedures</p> <ul style="list-style-type: none"> • Section I - Instructions to Bidders (ITB) • Section II - Bid Data Sheet (BDS) • Section III - Evaluation and Qualification Criteria • Section IV - Bidding Forms • Section V - Eligible Countries • Section VI - Fraud and Corruption <p>PART 2 Works' Requirements</p> <ul style="list-style-type: none"> • Section VII- Works' Requirements <p>PART 3 Conditions of Contract and Contract Forms</p> <ul style="list-style-type: none"> • Section VIII - General Conditions of Contract (GCC) • Section IX - Particular Conditions of Contract (PCC) • Section X - Contract Forms
	<p>6.2 The Specific Procurement Notice - Request for Bids (RFB) issued by the Employer is not part of this bidding document.</p>
	<p>6.3 Unless obtained directly from the Employer or downloaded from the official website specified in the 'E-Procurement Notice', the Employer is not responsible for the completeness of the bidding document, responses to requests for clarification, the minutes of the pre-Bid meeting (if any), or Addenda to the bidding document in accordance with ITB 8. In case of any contradiction, documents obtained directly from the Employer or downloaded from the official website specified in the 'E-Procurement Notice' shall prevail.</p>
	<p>6.4 The Bidder is expected to examine all instructions, forms, terms, and specifications in the bidding document and to furnish with its Bid all information and documentation as is required by the bidding document.</p>
<p>7. Clarification of Bidding Document, Site Visit, Pre-Bid</p>	<p>7.1 The electronic bidding system (https://kppp.karnataka.gov.in) specified in the BDS provides for online clarifications. A Bidder requiring any clarification on the bidding document may notify the Employer online or raise its inquiries during the pre-Bid meeting if provided for in accordance with ITB 7.4.</p>

Meeting	Clarifications requested through any other mode shall not be considered by the Employer. The Employer will respond to any request for clarification, provided that such request is received prior to the deadline for submission of Bids within a period specified in the BDS . Description of clarification sought and the response of the Employer shall be uploaded for information of all Bidders without identifying the source of request for clarification. Should the clarification result in changes to the essential elements of the bidding document, the Employer shall amend the bidding document following the procedure under ITB 8 and ITB 22.2. It is the bidder's responsibility to check on the e-procurement system, for any addendum/ amendment/ corrigendum to the bidding document.
	7.2 The Bidder is advised to visit and examine the Site of Works and its surroundings and obtain for itself on its own responsibility all information that may be necessary for preparing the bid and entering into a contract for construction of the Works. The costs of visiting the Site shall be at the Bidder's own expense.
	7.3 The Bidder and any of its personnel or agents will be granted permission by the Employer to enter upon its premises and lands for the purpose of such visit, but only upon the express condition that the Bidder, its personnel, and agents will release and indemnify the Employer and its personnel and agents from and against all liability in respect thereof, and will be responsible for death or personal injury, loss of or damage to property, and any other loss, damage, costs, and expenses incurred as a result of the inspection.
	7.4 If so specified in the BDS , the Bidder's designated representative is invited to attend a pre-Bid meeting and/or a Site of Works visit. The purpose of the meeting will be to clarify issues and to answer questions on any matter that may be raised at that stage.
	7.5 The Bidder is requested, to submit any questions only through the e-procurement portal, not later than one week before the meeting. Clarifications requested through any other mode shall not be considered by the Employer.
	7.6 Minutes of the pre-Bid meeting, if applicable, including the text of the questions asked by Bidders, without identifying the source, and the responses given, together with any responses prepared after the meeting, will be uploaded online on e-procurement system. Any modification to the bidding document that may become necessary as a result of the pre-Bid meeting shall be made by the Employer exclusively through the issue of an addendum pursuant to ITB 8 and not through the minutes of

	<p>the pre-Bid meeting. It is the bidder's responsibility to check on the e-procurement system, for any addendum/ amendment/ corrigendum to the bidding document. Nonattendance at the pre-Bid meeting will not be a cause for disqualification of a Bidder.</p>
8. Amendment of Bidding Document	8.1 At any time prior to the deadline for submission of bids, the Employer may amend the bidding document by issuing addenda.
	8.2 Any addendum issued shall be part of the bidding document and shall be deemed to have been communicated to all the bidders. The addenda will appear on the e-procurement system under "Latest Corrigendum", and Email notification is also automatically sent to those bidders who have started working on the tender, unless otherwise specified in the BDS . The Employer shall not be liable for any information not received by the bidder. It is the bidders' responsibility to verify the website for the latest information related to this bid.
	8.3 To give prospective Bidders reasonable time in which to take an addendum into account in preparing their Bids, the Employer may, at its discretion, extend the deadline for the submission of Bids, pursuant to ITB 22.2.
C. Preparation of Bids	
9. Cost of Bidding	9.1 The Bidder shall bear all costs associated with the preparation and submission of its Bid, and the Employer shall in no case be responsible or liable for those costs, regardless of the conduct or outcome of the Bidding process.
10. Language of Bid	10.1 The Bid, as well as all correspondence and documents relating to the Bid exchanged by the Bidder and the Employer, shall be written in English. Supporting documents and printed literature that are part of the Bid may be in another language provided they are accompanied by an accurate translation of the relevant passages in English, in which case, for purposes of interpretation of the Bid, such translation shall govern.
11. Documents Comprising the Bid	<p>11.1 The Bid shall comprise two Parts, namely the Technical Part and the Financial Part. These two Parts shall be submitted simultaneously.</p> <p>11.2 The Technical Part shall contain the following:</p> <p>(a) Letter of Bid– Technical Part prepared in accordance with ITB 12 and ITB 14;</p> <p>(b) Bid Security or Bid-Securing Declaration in accordance with</p>

	<p>ITB 19.1;</p> <ul style="list-style-type: none"> (c) Alternative Bid – Technical Part, if permissible, in accordance with ITB 13, the Technical Part of any Alternative Bid; (d) Authorization: written confirmation authorizing the signatory of the Bid to commit the Bidder, in accordance with ITB 20.3, and in accordance with ITB 20.4 in case of a JV; (e) Bidder’s Eligibility: documentary evidence in accordance with ITB 17 establishing the Bidder’s eligibility to Bid; (f) Qualifications: documentary evidence in accordance with ITB 17 establishing the Bidder’s qualifications to perform the contract if its Bid is accepted; (g) Conformity: a technical proposal in accordance with ITB 16; (h) Construction methodology as detailed in Para 1.1 of Section III Evaluation Criteria; (i) Contractor Registration certificate (as per RFB); and (j) any other document required in the BDS. <p>11.3 The financial forms are;</p> <ul style="list-style-type: none"> (a) Letter of Bid – Financial Part: prepared in accordance with ITB 12 and ITB 14; <i>(part of Completed Schedules and general/Special Conditions in KPP portal)</i> (b) Completed Schedules including priced Bill of Quantities in accordance with ITB 12 and ITB 14, as specified in BDS; (c) Alternative Bid - Financial Part: if permissible in accordance with ITB 13; and (d) any other document required in the BDS. <p>All relevant forms for the Financial Part, as referenced above, have been provided in the Completed Schedules section, along with the General/special conditions specified under KPPP.’</p> <p>11.4 The Technical Part shall not include any information related to the Bid price. Where material financial information related to the Bid price is contained in the Technical Part the Bid shall be declared non-responsive.</p> <p>11.5 In addition to the requirements under ITB 11.2, Bids submitted by a JV (where permitted) shall include a copy of the Joint Venture Agreement entered by all members. Alternatively, a</p>
--	---

	<p>letter of intent to execute a Joint Venture Agreement in the event of a successful Bid shall be signed by all members and submitted with the Bid, together with a copy of the proposed Agreement.</p> <p>11.6 The Bidder shall furnish in the Letter of Bid – Financial Part information on commissions and gratuities, if any, paid or to be paid to agents or any other party relating to this Bid.</p> <p>The declaration shall be taken under General/Special Condition in KPP portal. However, The document shall be taken from successful bidder in written post issue of Letter of Intent/ Letter of Acceptance.</p>
<p>12. Process of Bid Submission</p>	<p>12.1 The Letter of Bid – Technical Part, Letter of Bid – Financial Part, Schedules including Bill of Quantities, and all documents listed under Clause 11, shall be prepared using the relevant forms furnished in Section IV, Bidding Forms, if so provided. The forms must be completed without any alterations to the text, and no substitutes shall be accepted except as provided under ITB 20.3. All blank spaces shall be filled with the information requested.</p> <p>12.2 Entire Bid including the Letters of Bid, Schedules and filled-up Bill of Quantities shall be submitted online on e-procurement system specified in ITB 7.1. Details and process of online submission of the tender and relevant documents are given on the website mentioned above. Scanned copies of documents listed in ITB Clauses 11 and 12.3 should also be uploaded on this website.</p> <p>12.3 Submission of Original Documents: Not applicable</p>
<p>13. Alternative Bids</p>	<p>13.1 Unless otherwise specified in the BDS, alternative Bids shall not be considered.</p>
	<p>13.2 When alternative times for completion are explicitly invited, a statement to that effect will be included in the BDS and the method of evaluating different alternative times for completion will be described in Section III, Evaluation and Qualification Criteria.</p>
	<p>13.3 Except as provided under ITB 13.4 below, Bidders wishing to offer technical alternatives to the requirements of the bidding document must first price the Employer’s design as described in the bidding document and shall further provide all information necessary for a complete evaluation of the alternative by the Employer, including drawings, design calculations, technical specifications, breakdown of prices, and proposed construction methodology and other relevant details. Only the technical alternatives, if any, of the Bidder with the Most Advantageous</p>

	Bid conforming to the basic technical requirements shall be considered by the Employer.
	13.4 When specified in the BDS , Bidders are permitted to submit alternative technical solutions for specified parts of the Works. Such parts will be identified in the BDS and described in Section VII, Works' Requirements. The method for their evaluation will be stipulated in Section III, Evaluation and Qualification Criteria.
14. Bid Prices and Discounts	14.1 The prices and discounts quoted by the Bidder in the Letter of Bid – Financial Part and in the Schedules including Bill of Quantities shall conform to the requirements specified below.
	14.2 The Bidder shall submit a Bid for the whole of the Works described in ITB 1.1 by filling in prices for all items of the Works, as identified in Section IV - Bidding Forms along with the total bid price (both in figures and words). The Bidder shall fill in rates and prices for all items of the Works described in the Bill of Quantities. Items against which no rate or price is entered by the Bidder will not be paid for by the Employer when executed and shall be deemed covered by the rates for other items and prices in the Bill of Quantities. Corrections if any, in the bid can be carried out by editing the information before electronic submission on e-procurement portal.
	14.3 The price to be quoted in the Letter of Bid – Financial Part, in accordance with ITB 12.1, shall be the total price of the Bid, excluding any discounts offered.
	14.4 The Bidder shall quote any discounts and indicate the methodology for their application in the Letter of Bid – Financial Part in accordance with ITB 12.1.
	14.5 Unless otherwise specified in the BDS and the Conditions of Contract, the prices quoted by the Bidder shall be fixed.
	14.6 If so specified in ITB 1.1, Bids are invited for individual lots (contracts) or for any combination of lots (packages). Bidders wishing to offer discounts for the award of more than one Contract shall specify in their Bid the price reductions applicable to each package, or alternatively, to individual Contracts within the package. Discounts shall be submitted in accordance with ITB 14.4, provided the Bids for all lots (contracts) are opened at the same time.
	14.7 All duties, taxes, and other levies payable by the Contractor under the Contract, or for any other cause, as of the deadline for submission of Bids, shall be included in the rates and prices and

the total Bid price submitted by the Bidder.

- 14.8 Bidders may like to ascertain availability of tax/duty exemption benefits available in India. They are solely responsible for obtaining such benefits which they have considered in their bid and in case of failure to receive such benefits for reasons whatsoever, the Employer will not compensate the bidder (Contractor). The bidder shall furnish along with his bid a declaration to this effect in the Declaration Format provided in Section IV of the bidding document.

Where the bidder has quoted taking into account such benefits, it must give all information required for issue of certificates in terms of the Government of India's relevant Notifications as per the declaration format. In case the bidder has not provided the required information or has indicated to be furnished later on in the Declaration Format, the same shall be construed that the goods/construction equipment for which certificate is required is Nil.

To the extent the Employer determines the quantities indicated therein are reasonable keeping in view the quantities in bill of quantities, construction program and methodology, the certificates will be issued within 60 days of signing of the contract and no subsequent changes will be permitted. In case of materials pertaining to Variation items and quantities, the certificate shall be issued only on request from the Contractor when in need and duly certified by the Project Manager.

No certificate will be issued for items where no quantity/capacity of equipment is indicated in the statement.

If the bidder has considered the tax/duty exemption for materials/construction equipment to be bought for the work, the bidder shall confirm and certify that the Employer will not be required to undertake any responsibilities of the Government of India Scheme or the said exemptions being available during the contract execution, except issuing the required certificate. The bids which do not conform to the above provisions or any condition by the bidder which makes the bid subject to availability of tax/duty exemption for materials/construction equipment or compensation on withdrawal of any variations to the said exemptions will be treated as non-responsive and rejected.

Any delay in procurement of the construction equipment/machinery/goods as a result of the above shall not be a cause for granting any extension of time.

15. Currencies of Bid and Payment	15.1 The unit rates and prices shall be quoted by the Bidder and shall be paid for, entirely in Indian Rupees.
16. Documents Comprising the Technical Proposal	16.1 The Bidder shall furnish a technical proposal in the Technical Part of the Bid, including a statement of work methods, equipment, personnel, schedule and any other information as stipulated in Section IV, Bidding Forms, in sufficient detail to demonstrate the adequacy of the Bidders' proposal to meet the work's requirements and the completion time.
17. Documents Establishing the Eligibility and Qualifications of the Bidder	<p>17.1 To establish Bidder's eligibility in accordance with ITB 4, Bidders shall complete the Letter of Bid – Technical Part, included in Section IV, Bidding Forms.</p> <p>17.2 In accordance with Section III, Evaluation and Qualification Criteria, to establish its qualifications to perform the Contract, the Bidder shall provide the information requested in the corresponding information sheets included in Section IV, Bidding Forms.</p>
18. Period of Validity of Bids	18.1 Bids shall remain valid for 120 days or for the Bid Validity period specified in the BDS . The Bid Validity period starts from the date fixed for the Bid submission deadline (as prescribed by the Employer in accordance with ITB 22.1). A Bid valid for a shorter period shall be rejected by the Employer as nonresponsive.
	18.2 In exceptional circumstances, prior to the expiration of the Bid validity period, the Employer may request Bidders to extend the period of validity of their Bids. The request and the responses shall be made in writing. If a Bid Security is requested in accordance with ITB 19, it shall also be extended forty five (45) days beyond the deadline of the extended validity period. A Bidder may refuse the request without forfeiting its Bid Security. A Bidder granting the request shall not be required or permitted to modify its Bid, except as provided in ITB 18.3.
	18.3 If the award is delayed by a period exceeding fifty-six (56) days beyond the expiry of the initial Bid validity period, the Contract price shall be determined as follows:

	<p>(a) in the case of fixed price contracts, the Contract price shall be the Bid price adjusted by the factor specified in theBDS;</p> <p>(b) in the case of adjustable price contracts, no adjustment shall be made; or</p> <p>(c) in any case, Bid evaluation shall be based on the Bid price without taking into consideration the applicable correction from those indicated above.</p>
19. Bid Security	19.1 The Bidder shall furnish as part of the Technical Part of its Bid, either a Bid-Securing Declaration or a Bid Security as specified in the BDS , in original form and, in the case of a Bid security, for the amount specified in the BDS .
	19.2 A Bid Securing Declaration shall use the form included in Section IV, Bidding Forms.
	<p>19.3 If a Bid Security is specified pursuant to ITB 19.1, the Bid Security shall be a demand guarantee in any of the following forms at the Bidder's option:</p> <p>(a) an unconditional bank guarantee issued by a Nationalized or Scheduled bank located in India;</p> <p>(b) an irrevocable letter of credit issued by a Nationalized or Scheduled bank located in India;</p> <p>(c) a cashier's or certified check or demand draft issued by a Nationalized or Scheduled bank located in India;</p> <p>(d) another security specified in the BDS,</p> <p>In the case of a bank guarantee, the Bid Security shall be submitted using the Bid Security Form included in Section IV, Bidding Forms. The form must include the complete name of the Bidder. The Bid Security shall be valid for forty-five (45) days beyond the original validity period of the Bid, or beyond any period of extension if requested under ITB 18.2.</p>
	19.4 If a Bid Security or Bid Securing Declaration is specified pursuant to ITB 19.1, any Bid not accompanied by a substantially responsive Bid Security or Bid Securing Declaration shall be rejected by the Employer as non-responsive.
	19.5 If a Bid Security is specified pursuant to ITB 19.1, the Bid Security of unsuccessful Bidders shall be returned as promptly as possible upon the successful Bidder's signing the Contract and furnishing the Performance Security and if required in the BDS, the Environmental and Social (ES) Performance Security

	pursuant to ITB 50.
	19.6 The Bid Security of the successful Bidder shall be returned as promptly as possible once the successful Bidder has signed the Contract and furnished the required Performance Security and if required in the BDS, the Environmental and Social (ES) Performance Security.
	<p>19.7 The Bid Security may be forfeited or the Bid-Securing Declaration executed:</p> <ul style="list-style-type: none"> (a) if a Bidder withdraws/modifies/substitutes its Bid during the period of Bid validity specified by the Bidder on the Letter of Bid - Technical Part and repeated in Letter of Bid - Financial Part, or any extension thereto provided by the Bidder; or (b) if the Bidder does not accept the correction of its Bid Price pursuant to ITB 36; or (c) if the successful Bidder fails to: <ul style="list-style-type: none"> (i) sign the Contract in accordance with ITB 49; or (ii) furnish a Performance Security and if required in the BDS, the Environmental and Social (ES) Performance Security in accordance with ITB 50.
	19.8 The Bid Security or the Bid-Securing Declaration of a JV shall be in the name of the JV that submits the Bid. If the JV has not been constituted into a legally enforceable JV, at the time of Bidding, the Bid Security or the Bid-Securing Declaration shall be in the names of all future members as named in the letter of intent mentioned in ITB 4.1 and ITB 11.2.
	<p>19.9 If a Bid Security is not required in the BDS, pursuant to ITB 19.1, and:</p> <ul style="list-style-type: none"> (a) if a Bidder withdraws its Bid during the period of Bid validity specified by the Bidder in the Letters of Bid or any extended date provided by the Bidder; or (b) if the successful Bidder fails to: sign the Contract in accordance with ITB 49; or furnish a Performance Security and if required in the BDS, the Environmental and Social (ES) Performance Security in accordance with ITB 50; <p>the Borrower may, if provided for in the BDS, declare the Bidder ineligible to be awarded a contract by the Employer for a period of time as stated in the BDS.</p>

20. Format and Signing of Bid	20.1 The Bidder shall prepare the Bid as per details given in ITB 21.
	20.2 Bidders shall mark as “CONFIDENTIAL” information in their Bids which is confidential to their business.
	20.3 The Bid shall be signed by a person duly authorized to sign on behalf of the Bidder. This authorization shall consist of a written confirmation as specified in the BDS and shall be uploaded along with the Bid. The name and position held by each person signing the authorization must be typed or printed below the signature.
	<p>20.4 In case the Bidder is a JV, the Bid shall be signed by an authorized representative of the JV on behalf of the JV, and so as to be legally binding on all the members as evidenced by a power of attorney signed by their legally authorized representatives. Documents establishing authority to sign the bid on behalf of the JV shall be uploaded along with the bid.</p> <p>20.5 Any interlineations, erasures, or overwriting shall be valid only if they are signed or initialed by the person signing the Bid.</p>
D. Online Submission and Opening of Bids	
21. Preparation of Bids	21.1 Bids, both Technical and Financial Parts, shall be submitted online on the e-procurement system specified in BDS 7.1. Detailed guidelines for viewing bids and submission of online bids are given on the website (https://kppp.karnataka.gov.in). The Request for Bids under this Project is published on this website. Any citizen or prospective bidder can logon to this website and view the Request for Bids and can view the details of works for which bids are invited. A prospective bidder can submit its bid online; however, the bidder is required to have enrolment/registration in the website, and should have valid Digital Signature Certificate (DSC) in the form of smart card/e-token obtained from any certifying agency authorised by the Government of India (for class of DSC specified in BDS). The bidder should register in the website using the relevant option available. Then the Digital Signature registration has to be done with the e-token, after logging into the website. The bidder can then login the website through the secured login by entering the password of the e-token & the user id/ password chosen during registration. After getting the bid schedules, the Bidder should go through them carefully and submit the specified documents, along with the bid, otherwise the bid will be rejected.

	21.2 The completed bid comprising of documents indicated in ITB 12, should be uploaded on the e-procurement portal along with scanned copies of requisite certificates as are mentioned in different sections in the bidding document. The bid security needs to be paid online only through KPP portal (https://kppp.karnataka.gov.in).
	21.3 All the documents are required to be signed digitally by the bidder. After electronic online bid submission, the system generates a unique bid identification number which is time stamped as per server time. This shall be treated as acknowledgement of bid submission.
	21.4 Physical, e-mail, Telex, Cable or Facsimile bids will be rejected as non-responsive.
22. Deadline for Submission of Bids	22.1 Bids, both Technical and Financial Parts, must be uploaded online no later than the date and time specified in the BDS .
	22.2 The Employer may, at its discretion, extend the deadline for the submission of Bids by amending the bidding document in accordance with ITB 8, in which case all rights and obligations of the Employer and Bidders previously subject to the deadline shall thereafter be subject to the deadline as extended.
23. Late Bids	23.1 The electronic bidding system would not allow any late submission of bids after due date & time as per server time.
24. Withdrawal, Substitution, and Modification of Bids	24.1 Bidders may modify their bids by using the appropriate option for bid modification on e-procurement portal, before the deadline for submission of bids. For this the bidder need not make any additional payment towards the cost of bid document. For bid modification and consequential re-submission, the bidder is not required to withdraw his bid submitted earlier. The last modified bid submitted by the bidder within the bid submission time shall be considered as the bid. For this purpose, modification/withdrawal by other means will not be accepted. In online system of bid submission, the modification and consequential re-submission of bids is allowed any number of times. A bidder may withdraw his bid by using the appropriate option for bid withdrawal, before the deadline for submission of bids, however, if the bid is withdrawn, re-submission of the bid is not allowed (or allowed if specified in BDS).
	24.2 Bids requested to be withdrawn in accordance with ITB 24.1 shall not be opened.
	24.3 No Bid may be withdrawn, substituted, or modified in the

	<p>interval between the deadline for submission of Bids and the expiration of the period of Bid validity specified by the Bidder on the Letter of Bid or any extension thereof. This will result in the forfeiture of the Bid Security pursuant to ITB 19.7.</p>
<p>E. Public Opening of Technical Parts of Bids</p>	
<p>25. Public Opening of Technical Parts of Bids</p>	<p>25.1 The Employer shall publicly open Technical Parts of all Bids received by the deadline, at the date, time and place specified in the BDS, in the presence of Bidders’ designated representatives and anyone who chooses to attend, and this could also be viewed by the bidders online. The Financial Parts of the bids shall remain unopened in the e-procurement system, until the subsequent public opening, following the evaluation of the Technical Parts of the Bids. In all cases, original documents submitted as specified in ITB 12.3 shall be first scrutinized, and Bids that do not comply with the provisions of ITB 12.3 will be declared non-responsive and will not be opened. Thereafter, bidders’ names, the presence or absence of a Bid Security or Bid Securing Declaration, if one was required, alternative bids – technical parts, if any, and such other details as the Employer may consider appropriate will be notified, online by the Employer at the time of bid opening. (Bid security needs to be paid online only through KPP Portal. No other form shall be accepted)</p> <p>In the event of the specified date of bid opening being declared a holiday for the Employer, the bids will be opened at the appointed time and location on the next working day.</p> <p>25.2 The electronic summary of the bid opening will be generated and uploaded online. The Employer will also prepare minutes of the Bid opening, including the information disclosed and upload the same for viewing online. Only Technical Parts of Bids, and technical parts of Alternative Bids if any, that are opened at technical Bid opening shall be considered further for evaluation.</p>
<p>F. Evaluation of Bids – General Provisions</p>	
<p>26. Confidentiality</p>	<p>26.1 Information relating to the evaluation of Bids and recommendation of contract award, shall not be disclosed to Bidders or any other persons not officially concerned with the Bidding process until information on Intention to Award the Contract is transmitted to all Bidders in accordance with ITB 45. In cases where ITB 45 is not applicable, such information shall not be disclosed until Notification of Award is transmitted in accordance with ITB 47.</p>

	26.2 Any effort by a Bidder to influence the Employer in the evaluation of the Bids or Contract award decisions may result in the rejection of its Bid.
	26.3 Notwithstanding ITB 26.2, from the time of Bid opening to the time of Contract award, if a Bidder wishes to contact the Employer on any matter related to the Bidding process, it shall do so in writing.
27. Clarification of Bids	27.1 To assist in the examination, evaluation, and comparison of the Bids, and qualification of the Bidders, the Employer may, at its discretion, ask any Bidder for a clarification of its Bid giving a reasonable time for a response. Any clarification submitted by a Bidder that is not in response to a request by the Employer shall not be considered. The Employer's request for clarification and the response shall be in writing. No change, including any voluntary increase or decrease in the prices or substance of the Bid shall be sought, offered, or permitted, except to confirm the correction of arithmetic errors discovered by the Employer in the evaluation of the Bids, in accordance with ITB 36.
	27.2 If a Bidder does not provide clarifications of its Bid by the date and time set in the Employer's request for clarification, its Bid may be rejected.
28. Deviations, Reservations, and Omissions	28.1 During the evaluation of Bids, the following definitions apply: <ul style="list-style-type: none"> (a) "Deviation" is a departure from the requirements specified in the bidding document; (b) "Reservation" is the setting of limiting conditions or withholding from complete acceptance of the requirements specified in the bidding document; and (c) "Omission" is the failure to submit part or all of the information or documentation required in the bidding document.
29. Nonmaterial Nonconformities	29.1 Provided that a Bid is substantially responsive, the Employer may waive any nonconformities in the Bid which do not constitute a material deviation, reservation or omission.
	29.2 Provided that a Bid is substantially responsive, the Employer may request that the Bidder submit the necessary information or documentation, within a reasonable period of time, to rectify nonmaterial nonconformities in the Bid related to documentation requirements. Requesting information or documentation on such nonconformities shall not be related to any aspect of the price or substance of the Bid. Failure of the Bidder to comply with the

	request may result in the rejection of its Bid.
	29.3 Provided that a Bid is substantially responsive, the Employer shall rectify quantifiable nonmaterial nonconformities related to the Bid Price. To this effect, the Bid Price shall be adjusted, for comparison purposes only, to reflect the price of a missing or nonconforming item or component in the manner specified in the BDS .
G. Evaluation of Technical Parts of Bids	
30. Evaluation of Technical Parts	30.1 In evaluating the Technical Parts of each Bid, the Employer shall use the criteria and methodologies listed in this ITB and Section III, Evaluation and Qualification Criteria. No other evaluation criteria or methodologies shall be permitted.
31. Determination of Responsiveness	<p>31.1 The Employer's determination of a Bid's responsiveness is to be based on the contents of the Bid itself, as defined in ITB 11.</p> <p>31.2 A substantially responsive Bid is one that meets the requirements of the bidding document without material deviation, reservation, or omission. A material deviation, reservation, or omission is one that:</p> <ul style="list-style-type: none"> (a) if accepted, would: <ul style="list-style-type: none"> (i) affect in any substantial way the scope, quality, or performance of the Works specified in the Contract; or (ii) limit in any substantial way, inconsistent with the bidding document, the Employer's rights or the Bidder's obligations under the proposed Contract; or (b) if rectified, would unfairly affect the competitive position of other Bidders presenting substantially responsive Bids.
	31.3 The Employer shall examine the technical aspects of the Bid submitted in accordance with ITB 16, in particular, to confirm that all requirements of Section VII, Works' Requirements have been met without any material deviation, reservation or omission.
	31.4 If a Bid is not substantially responsive to the requirements of the bidding document, it shall be rejected by the Employer and may not subsequently be made responsive by correction of the material deviation, reservation, or omission.
32. Qualification of the Bidder	32.1 The Employer shall determine to its satisfaction whether the eligible Bidders that have submitted substantially responsive

	Bid - Technical Parts meet the qualifying criteria specified in Section III, Evaluation and Qualification Criteria.
	32.2 The determination shall be based upon an examination of the documentary evidence of the Bidder's qualifications submitted by the Bidder, pursuant to ITB 17. The determination shall not take into consideration the qualifications of other firms such as the Bidder's subsidiaries, parent entities, affiliates, subcontractors (other than Specialized Subcontractors if permitted in the bidding document), or any other firm different from the Bidder.
	32.3 If a Bidder does not meet the qualifying criteria specified in Section III, Evaluation and Qualification Criteria, its Bid shall be rejected by the Employer and may not subsequently be made responsive by correction of the material deviation, reservation, or omission.
	32.4 Only Bids that are both substantially responsive to the bidding document and meet all Qualification Criteria shall have the Financial Parts of their Bids opened at the second public opening.
33. Subcontractors	<p>33.1 Unless otherwise stated in the BDS, the Employer does not intend to execute any specific elements of the Works by subcontractors selected in advance by the Employer.</p> <p>33.2 The subcontractor's qualifications shall not be used by the Bidder to qualify for the Works unless their specialized parts of the Works were previously designated by the Employer in the BDS as can be met by subcontractors referred to hereafter as 'Specialized Subcontractors', in which case, the qualifications of the Specialized Subcontractors proposed by the Bidder may be added to the qualifications.</p> <p>33.3 Bidders may propose subcontracting up to the percentage of total value of contracts or the volume of works as specified in the BDS. Subcontractors proposed by the Bidder shall be fully qualified for their parts of the Works.</p>
H. Public Opening of Financial Parts of Bids	
34. Public Opening of Financial Parts	34.1 Following the completion of the evaluation of the Technical Parts of the Bids, and the Bank has issued its no objection (if applicable), the Employer shall notify in writing those Bidders whose Bids were considered non-responsive to the bidding document or failed to meet the Qualification Criteria, advising them of the following information:

	<ul style="list-style-type: none"> (a) the grounds on which their Technical Part of Bid failed to meet the requirements of the bidding document. (b) their Financial Part of Bid shall not be opened; and (c) notify them of the date, time, and location for public opening of Financial Parts of the Bids.
	<p>34.2 The Employer shall, simultaneously, notify in writing those Bidders whose Technical Part have been evaluated as substantially responsive to the bidding document and met all Qualifying Criteria, advising them of the following information:</p> <ul style="list-style-type: none"> (a) their Bid has been evaluated as substantially responsive to the bidding document and met the Qualification Criteria; (b) their Financial Part of Bid will be opened at the public opening of the Financial Parts; and (c) notify them of the date, time and location for public opening of the Financial Parts of the Bids, as specified in the BDS.
	<p>34.3 The opening date should allow Bidders sufficient time to make arrangements for attending the opening. The Financial Part of the Bids shall be opened publicly in the presence of Bidders' designated representatives and anyone who chooses to attend, and this could also be viewed by the bidders online. The bidder's names, the Bid prices, per lot (contract) if applicable, including any discounts and Alternative Bid - Financial Part if any, and such other details as the Employer may consider appropriate, will be notified online by the Employer at the time of bid opening.</p> <p>In the event of the specified date of bid opening being declared a holiday for the Employer, the bids will be opened at the appointed time and location on the next working day.</p>
	<p>34.4 The electronic summary of the bid opening will be generated and uploaded online. The Employer will also prepare minutes of the Bid opening, including the information disclosed and upload the same for viewing online. Only Financial Parts of Bids, Financial Parts of Alternative Bids, and discounts that are opened at Bid opening shall be considered further for evaluation.</p>
I. Evaluation of Financial Parts of Bids	
35. Evaluation of Financial Parts	<p>35.1 To evaluate the Financial Part, the Employer shall consider the following:</p>

	(a) the Bid price, excluding Provisional Sums and the provision, if any, for contingencies in the Summary Bill of Quantities for admeasurement contracts, but including Daywork ¹ items, where priced competitively;
	(b) price adjustment for correction of arithmetic errors in accordance with ITB 36.1;
	(c) price adjustment due to discounts offered in accordance with ITB 14.4;
	(d) Not used;
	(e) price adjustment due to quantifiable nonmaterial nonconformities in accordance with ITB 29.3; and
	(f) the additional evaluation factors are specified in Section III, Evaluation and Qualification Criteria.
	35.2 The estimated effect of the price adjustment provisions of the Conditions of Contract, applied over the period of execution of the Contract, shall not be taken into account in Bid evaluation.
	35.3 If this bidding document allows Bidders to quote separate prices for different lots (contracts), the methodology to determine the lowest evaluated cost of the contract combinations, including any discounts offered in the Letter of Bid – Financial Part, is specified in Section III, Evaluation and Qualification Criteria
36. Correction of Arithmetical Errors	<p>36.1 In evaluating the Financial Part of each Bid, the Employer shall correct arithmetical errors on the following basis:</p> <p>(a) only for admeasurement contracts, if there is a discrepancy between the unit price and the total price that is obtained by multiplying the unit price and quantity, the unit price shall prevail and the total price shall be corrected;</p> <p>(b) if there is an error in a total corresponding to the addition or subtraction of subtotals, the subtotals shall prevail and the total shall be corrected; and</p> <p>(c) if there is a discrepancy between words and figures, the</p>

¹ Daywork is work carried out following instructions of the Project Manager and paid for on the basis of time spent by workers, and the use of materials and the Contractor's equipment, at the rates quoted in the Bid. For Daywork to be priced competitively for Bid evaluation purposes, the Employer must list tentative quantities for individual items to be costed against Daywork (e.g., a specific number of tractor driver staff-days, or a specific tonnage of Portland cement), to be multiplied by the Bidders' quoted rates and included in the total Bid price.

	<p>amount in words shall prevail, unless the amount expressed in words is related to an arithmetic error, in which case the amount in figures shall prevail subject to (a) and (b) above.</p>
	<p>36.2 Bidders shall be requested to accept correction of arithmetical errors. Failure to accept the correction in accordance with ITB 36.1, shall result in the rejection of the Bid and the Bid Security may be forfeited in accordance with ITB Sub-Clause 19.7.</p>
<p>37. Conversion to Single Currency</p>	<p>37.1 Not used.</p>
<p>38. Margin of Preference</p>	<p>38.1 Not applicable.</p>
<p>39. Comparison of Financial Parts</p>	<p>39.1 The Employer shall compare the evaluated costs of all responsive and qualified Bids to determine the Bid that has the lowest evaluated cost.</p>
<p>40. Abnormally Low Bids</p>	<p>40.1 An Abnormally Low Bid is one where the Bid price, in combination with other constituent elements of the Bid, appears unreasonably low to the extent that the Bid price raises material concerns as to the capability of the Bidder to perform the Contract for the offered Bid price.</p> <p>40.2 In the event of identification of a potentially Abnormally Low Bid, the Employer, unless otherwise specified in the BDS, shall seek written clarifications from the Bidder, including detailed price analyses of its Bid price in relation to the subject matter of the contract, scope, proposed methodology, schedule, allocation of risks and responsibilities and any other requirements of the bidding document.</p> <p>40.3 After evaluation of the price analyses, in the event that the Employer determines that the Bidder has failed to demonstrate its capability to perform the Contract for the offered Bid Price, the Employer shall reject the Bid.</p>
<p>41. Unbalanced or Front-Loaded Bids</p>	<p>41.1 If the Bid for an admeasurement contract, which results in the lowest evaluated cost is, in the Employer's opinion, seriously unbalanced or, front-loaded, the Employer may require the Bidder to provide written clarifications. Clarifications may include detailed price analyses (with breakdown of unit rates) to demonstrate the consistency of the Bid prices with the scope of works, proposed methodology, schedule and any other requirements of the bidding document.</p> <p>41.2 After the evaluation of the information and detailed price analysis presented by the Bidder, the Employer may as</p>

	<p>appropriate:</p> <ul style="list-style-type: none"> (a) accept the Bid without any additional Performance Security; or (b) require that the amount of the Performance Security be increased at the expense of the Bidder to a level not exceeding twenty percent (20%) of the Contract Price to protect the Employer against financial loss in the event of default of the successful Bidder under the Contract; or (c) reject the Bid if the risk cannot be mitigated through additional performance security.
42. Most Advantageous Bid	<p>42.1 Having compared the evaluated costs of Bids, the Employer shall determine the Most Advantageous Bid. The Most Advantageous Bid is the Bid of the Bidder that meets the Qualification Criteria and whose Bid has been determined to be:</p> <ul style="list-style-type: none"> (a) substantially responsive to the bidding document; and (b) the lowest evaluated cost.
43. Employer's Right to Accept Any Bid, and to Reject Any or All Bids	<p>43.1 The Employer reserves the right to accept or reject any Bid, and to annul the Bidding process and reject all Bids at any time prior to Contract Award, without thereby incurring any liability to Bidders. In case of annulment, all documents submitted and specifically, Bid securities, shall be promptly returned to the Bidders.</p>
44. Standstill Period	<p>44.1 Standstill Period shall not apply.</p>
45. Notice of Intention to Award	<p>45.1 Not used.</p>
J. Award of Contract	
46. Award Criteria	<p>46.1 Subject to ITB 43, the Employer shall award the Contract to the successful Bidder. This is the Bidder whose Bid has been determined to be the Most Advantageous Bid as specified in ITB 42.</p>
47. Notification of Award	<p>47.1 Prior to the expiration of the Bid Validity Period, the Employer shall transmit the Letter of Acceptance to the successful Bidder. The Letter of Acceptance shall specify the sum that the Employer will pay the Contractor in consideration of the execution of the contract (hereinafter and in the Conditions of</p>

	<p>Contract and Contract Forms called “the Contract Price”).</p> <p>47.2 Within ten (10) Business Days after the date of transmission of the Letter of Acceptance, the Employer shall publish the Contract Award Notice which shall contain, at a minimum, the following information:</p> <ul style="list-style-type: none"> (a) name and address of the Employer; (b) name and reference number of the contract being awarded, and the selection method used; (c) names of all Bidders that submitted Bids, and their Bid prices as read out at Bid opening, and as evaluated; (d) names of all Bidders whose Bids were rejected either as nonresponsive or as not meeting qualification criteria, or were not evaluated, with the reasons therefor; and (e) the name of the successful Bidder, the final total contract price, the contract duration and a summary of its scope.
	<p>47.3 The Contract Award Notice shall be published on a National website (on the Employer’s website (RDWSD Karnataka – Official Website) and KERS website)</p>
	<p>47.4 Until a formal contract is prepared and executed, the notification of award shall constitute a binding Contract.</p>
48. Debriefing by the Employer	<p>48.1 Not used.</p>
49. Signing of Contract	<p>49.1 Promptly upon Notification of Award, the Employer shall prepare the Contract Agreement and keep it ready in the office of the Employer for the signature of the Employer and the successful Bidder, within 21 days following the date of Letter of Acceptance. The Contract Agreement shall incorporate all agreements between the Employer and the successful Bidder.</p>
	<p>49.2 Within twenty-one (21) days of receipt of the Letter of Acceptance, the successful Bidder shall (a) furnish the performance security and if required in the BDS, the Environmental and Social (ES) Performance Security in accordance with ITB Clause 50 and revised construction methodology; (b) if the successful bidder is a JV, it shall also furnish the JV agreement duly signed by all the members, if it had submitted only a letter of intent to execute the JV agreement along with the bid; and (c) shall sign, date and return the Agreement to the Employer along with the documents stated at (a) and (b) above.</p>

<p>50. Performance Security</p>	<p>Add The successful Bidder shall also be required to submit an Environmental and Social (ES) Performance Security. [Note: The ES Performance Security shall normally be required where ES risks are significant.] Throughout this bidding document the term 'performance security', unless the context clearly indicates otherwise, means and includes both 'the performance security and the ES performance security' to be submitted by the successful bidder in the amounts specified in GCC/ PCC 54. 50.1</p>
	<p>50.2 Failure of the successful Bidder to submit the above-mentioned Performance Security and if required in the BDS, the Environmental and Social (ES) Performance Security or to sign the Contract Agreement shall constitute sufficient grounds for the annulment of the award and forfeiture of the Bid Security. In that event the Employer may award the Contract to the Bidder offering the next Most Advantageous Bid.</p> <p>50.3 Upon the successful Bidder's signing the Agreement and furnishing of the Performance Security and if required in the BDS, the Environmental and Social (ES) Performance Security pursuant to ITB Clause 50.1, the Employer shall promptly notify the name of the winning bidder to each unsuccessful bidder and shall discharge the Bid Securities of the bidders pursuant to ITB Clause 19.5 and 19.6.</p>
<p>51. Adjudicator</p>	<p>51.1 The Employer proposes the person named in the BDS to be appointed as Adjudicator under the Contract, at the daily fee specified in the BDS, plus reimbursable expenses (actual boarding, lodging, travel and other incidental expenses). If the Bidder disagrees with this proposal, the Bidder should so state in his Bid. If, in the Letter of Acceptance, the Employer does not agree on the appointment of the Adjudicator, the Employer will request the Appointing Authority designated in the Particular Conditions of Contract (PCC) pursuant to Clause 23.1 of the General Conditions of Contract (GCC), to appoint the Adjudicator.</p>

Section II - Bid Data Sheet (BDS)

The following specific data for the Works to be procured shall complement, supplement, or amend the provisions in the Instructions to Bidders (ITB). Whenever there is a conflict, the provisions herein shall prevail over those in ITB.

ITB Reference	A. General
ITB 1.1	<p>The number of the Request for Bids is: <i>One (1)</i></p> <p>The Employer is: <i>Rural Drinking Water and Sanitation Department (RDWSD)</i></p> <p>The reference number of the Request for Bids (RFB) is: IN-KERS-458926-CW-RFB</p> <p>The name of the RFB is: Construction of Material Recovery Facility at Hebri Grama Panchayat, Hebri Taluk, Udupi District (upgrading from 5 TPD to 7 TPD).</p> <p>The number and identification of lots (contracts) comprising this RFB is: one (1) Lot only.</p>
ITB 1.2	The Employer shall use the e-procurement system specified in BDS 7.1.
ITB 2.1	<p>The Borrower is: Government of India. The sub-borrower is Government of Karnataka.</p> <p>Loan Agreement amount: 71 million US\$</p> <p>The name of the Project is: Karnataka Strengthening Coastal Resilience and the Economy Project (K-SHORE)</p>
ITB 4.1	Bids from Joint ventures are not acceptable.
ITB 4.5	A list of debarred firms and individuals is available on the Bank's external website: http://www.worldbank.org/debarr .
ITB 4.7	Deleted
B. Contents of Bidding Document	
ITB 7.1	<p>Electronic – Procurement System</p> <p>The Employer shall use the following electronic-procurement system to manage this Bidding process: https://kppp.karnataka.gov.in</p> <p>Requests for clarification should be received by the Employer no later than 25.11.2024 prior to the deadline for submission of bids.</p>

<p>ITB 7.4</p>	<p>A Pre-Bid meeting <i>Shall</i> take place.</p> <p>If a Pre-Bid meeting will take place, it will be at the following date, time and place: 13.11.2024, 1100 hours IST, Office of Executive Engineer, UdupiDivision, RDWSD, Udupi, UdupiDistrict, Karnataka State, India.</p> <p>A site visit conducted by the Employer shall be organized.</p>				
<p>ITB 8.2</p>	<p>The Corrigendum / addendum will appear on the e-procurement system under https://kppp.karnataka.gov.in under “Latest Corrigendum” and email notification is also automatically sent to those bidders who have started working on this tender. The same may also be seen in the Departmental website http://eparihara.aranya.gov.in/kers/public/kshore/ and https://english.swachhamevajayate.org/</p>				
<p>C. Preparation of Bids</p>					
<p>ITB 11.2 (j)</p>	<p>The Bidder shall submit the following additional documents in its bid – Technical Part: The bidder shall submit the following along with their bid:</p> <p>i. Documents as listed in the table below in addition to the required forms as briefed in ITC 16 and ITC 17.</p> <table border="1" data-bbox="475 1041 1396 1938"> <tr> <td data-bbox="475 1041 781 1423"> <p>Certificate</p> </td> <td data-bbox="789 1041 1396 1423"> <ol style="list-style-type: none"> 1. Latest Professional Tax Payment Certificate (PTPC) 2. Valid PAN Card in the name of bidder/organization. 3. Income Tax Return of current Assessment year or, IT Return of immediately preceding Assessment year whichever latest available. 4. Valid GST Registration Certificate under GST Act & Rules. </td> </tr> <tr> <td data-bbox="475 1434 781 1938"> <p>Company Details</p> </td> <td data-bbox="789 1434 1396 1938"> <ol style="list-style-type: none"> 1. For Proprietorship Firms, Partnership Firms, Registered Companies, Registered Cooperative Societies, Valid Trade License/ acknowledgement or Receipt of application for Trade License/ Revalidation. 2. Other Requirement: For Partnership Firms: Legally valid Partnership Deed, Trade License, Form-VIII/ Memorandum of Registration of Registrar of Firms. 3. For Companies: Incorporation Certificate, Trade License, Memorandum of Articles of ROC, List of current owners/ Directors/Board Members </td> </tr> </table>	<p>Certificate</p>	<ol style="list-style-type: none"> 1. Latest Professional Tax Payment Certificate (PTPC) 2. Valid PAN Card in the name of bidder/organization. 3. Income Tax Return of current Assessment year or, IT Return of immediately preceding Assessment year whichever latest available. 4. Valid GST Registration Certificate under GST Act & Rules. 	<p>Company Details</p>	<ol style="list-style-type: none"> 1. For Proprietorship Firms, Partnership Firms, Registered Companies, Registered Cooperative Societies, Valid Trade License/ acknowledgement or Receipt of application for Trade License/ Revalidation. 2. Other Requirement: For Partnership Firms: Legally valid Partnership Deed, Trade License, Form-VIII/ Memorandum of Registration of Registrar of Firms. 3. For Companies: Incorporation Certificate, Trade License, Memorandum of Articles of ROC, List of current owners/ Directors/Board Members
<p>Certificate</p>	<ol style="list-style-type: none"> 1. Latest Professional Tax Payment Certificate (PTPC) 2. Valid PAN Card in the name of bidder/organization. 3. Income Tax Return of current Assessment year or, IT Return of immediately preceding Assessment year whichever latest available. 4. Valid GST Registration Certificate under GST Act & Rules. 				
<p>Company Details</p>	<ol style="list-style-type: none"> 1. For Proprietorship Firms, Partnership Firms, Registered Companies, Registered Cooperative Societies, Valid Trade License/ acknowledgement or Receipt of application for Trade License/ Revalidation. 2. Other Requirement: For Partnership Firms: Legally valid Partnership Deed, Trade License, Form-VIII/ Memorandum of Registration of Registrar of Firms. 3. For Companies: Incorporation Certificate, Trade License, Memorandum of Articles of ROC, List of current owners/ Directors/Board Members 				

		<p>4. For State Registered Co-operative Societies: Society Registration certificate from ARCS of the State, Society By-Laws, latest available Auditor's Report of Directorate of Co-operative Audit within preceding five years as per Societies Act & Rules.</p>
	<p>Credential of work</p>	<p>1. Work Order/ Award of Contract alongwithBoQ/SoR and LOA/LOI duly authenticated by issuing authority. 2. Work completion Certificates should comprise with tender number, work order number, BoQ, tendered amount, amount put to tender, date of commencement, date of completion (in all respect), payment certificate etc. duly authenticated by competent authority.</p>
	<p>Financial Information</p>	<p>Profit & Loss accounts and audited balance sheets along with relevant annexures, as applicable under IT Act, in the name of the bidder for any three financial years within the zone of preceding five financial years from date of publication of RFB.</p>
	<p>ii. Contractor Registration certificate on e-procurement system as per RFB</p> <p>iii. Code of Conduct for Contractor's Personnel (ES)</p> <p>The Bidder shall submit its Code of Conduct that will apply to Contractor's Personnel (as defined in Sub-Clause 1 (ii) of the General Conditions of Contract), to ensure compliance with the Contractor's Environmental and Social (ES) obligations under the Contract. The Bidder shall use for this purpose the Code of Conduct form provided in Section IV. No substantial modifications shall be made to this form, except that the Bidder may introduce additional requirements, including as necessary to take into account specific Contract issues/risks.</p> <p>iv. Management Strategies and Implementation Plans (MSIP) to manage the (ES) risks</p> <p>The Bidder shall submit Management Strategies and Implementation Plans (MSIPs) to manage the following key Environmental and Social (ES) risks:</p> <ul style="list-style-type: none"> • Labour health and Safety Plan due to occupational hazards, • Implementation plan of the Environmental, Social, Health, and Safety (ESHS) plan and • Boundary Marking and Protection Strategy for mobilization and construction to prevent offsite adverse impacts. 	
<p>ITB 11.3 (b)</p>	<p>The following schedules shall be submitted with the bid:</p>	

	<p>(i) Letter of Bid for Technical Part</p> <p>(ii) Technical Proposal forms</p> <p>(iii) Letter of Bid for Financial Part (<i>only Declaration through Special/General Conditions on KPP portal. The form shall be taken in written from successful bidder post issue of Letter of Intent/Acceptance</i>)</p> <p>(iv) The Priced Bill of Quantities</p> <p>(v) Scanned copy of Registration on e-procurement website</p> <p>(vi) Scanned copy of affidavit regarding the correctness of information furnished with the bid document</p> <p>(vii) Scanned copy of bid security in approved form</p> <p>(viii) Scanned copy of Registration on e-procurement website</p> <p>(ix) Scanned copy of affidavit regarding the correctness of information furnished with the bid document</p> <p>(x) Time schedule for project implementation</p> <p>(xi) All other relevant documents as stated in the bid</p>
ITB 11.3 (d)	The Bidder shall submit the following additional documents in its Bid: No extra documents should be uploaded in the Financial Proposal section on the KPP portal except for the completed schedule, including the priced Bill of Quantities as per ITB 12 and ITB 14. The bidder shall enter the prices directly in the given field against each item on KPP portal.
ITB 12	Note for Bidders: Bidders must submit the bids on the e-procurement portal along with the relevant required documents. For this purpose, the bidders shall fill up in the forms that are available for online filling on the e-portal. The rest of the forms shall be downloaded by the bidders and filled up. The filled-up pages shall then be scanned and uploaded on the e-procurement portal along with the scanned copies of the supporting documents.
ITB 12.3	For submission of original documents, the Employer's address is: Not Applicable
ITB 13.1	Alternative Bids <i>shall not be</i> permitted.
ITB 13.2	Alternative times for completion <i>shall not be</i> permitted.
ITB 13.3	Not Applicable
ITB 13.4	Alternative technical solutions shall be permitted for the following parts of the Works: Not Applicable
ITB 14.5	<p>The prices quoted by the Bidder shall not be subject to adjustment during the performance of the Contract.</p> <p>The adjustment of contract price, if provided, will be done in accordance with GCC Clause 49 and corresponding provisions under PCC and Appendix 2 to PCC.</p>

ITB 18.1	The Bid validity period shall be 120 days.
ITB 18.3 (a)	The Bid price shall be adjusted by the following factor: 5% per annum.
ITB 19.1	<p>A Bid Security shall be required. A Bid-Securing Declaration shall not be required. The requisite bid Security shall be paid in e-Payment as specified in e-Procurement portal (https://kppp.karnataka.gov.in) using any of the following payments modes.</p> <ul style="list-style-type: none"> • Credit card. • Direct debit • National Electronic Fund Transfer (NEFT). <p>a) The bidders will be evaluated on confirming of receipt of the payment (bid security) in the Government of Karnataka Central pooling Account.</p> <p>b) The entire bid security for a particular tender has to be paid in a single transaction. it is responsibility of Bidders to ensure that payment through NEFT reaches GoK Bank before Bid submission date and time, through online payment.</p> <p>The Bidder shall furnish a Bid Security in the amount of INR 2,72,500.00</p>
ITB 19.3 (d)	Other types of acceptable securities are: None are accepted other than bid Security which shall be paid online through KPP portal. The Bid Security shall be valid for forty-five (45) days beyond the original validity period of the Bid, or beyond any period of extension if requested under ITB 18.2.
ITB 19.9	Deleted (unless the Employer proposes use of bid securing declaration as bid security).
ITB 20.3	<p>The written confirmation of authorization to sign on behalf of the Bidder shall consist of:</p> <p>(a) Legally valid Power of Attorney is required to demonstrate the authority of the signatory to sign the Bid.</p> <p>(b) Not Applicable</p> <p>Note: Upload each and every page of bid document along with necessary testimonials duly digitally signed by the authorized person on behalf of the Bidder.</p>
D. Online Submission and Opening of Bids	
ITB 21.1	Class of DSC required is: Class I and II
ITB 22.1	<p>The deadline for uploading the Bids is:</p> <p>Date: 09th December 2024</p> <p>Time: 1600 hours IST</p>
ITB 24.1	Re-submission of the bid is not allowed, if withdrawn.

E. Public Opening of Technical Parts of Bids	
ITB 25.1	<p>The online Bid opening of Technical Parts of Bids shall take place at:</p> <p>Executive Engineer, Udupi Division, Rural Drinking Water and Supply Department (RDWSD), Udupi 576104, Udupi District, Karnataka, India.</p> <p>Date: 10th December 2024 Time: 1630 hours IST</p>
F. Evaluation of Bids – General Provisions	
ITB 29.3	<p>The adjustment shall be based on the highest price of the item or component as quoted in other substantially responsive Bids, subject to a maximum of the estimated price of the item. If the price of the item or component cannot be derived from the price of other substantially responsive Bids, the Employer shall use its best estimate.</p>
G. Evaluation of Bids - Technical Parts	
ITB 33.1	<p>At this time the Employer does not intend to execute certain specific parts of the Works by subcontractors selected in advance.</p>
ITB 33.2	<p>NA</p>
ITB 33.3	<p>(a) Contractor's proposed subcontracting: Maximum percentage of subcontracting permitted is: <i>10% of the total contract amount or 10% of the volume of work.</i></p> <p>(b) the Bidder planning to subcontract more than 10% of total volume of work shall specify, in the Letter of Bid, the activity (ies) or parts of the Works to be subcontracted along with complete details of the subcontractors and their qualification and experience, to be collected through email post Letter of Intent is awarded. The qualifications and experience of the sub-contractors must meet the minimum criteria for the relevant work to be sub-contracted failing which such sub-contractors will not be permitted to participate.</p> <p>(c) Subcontractors' qualification and experience will not be considered for evaluation of the Bidder. The Bidder on its own (without taking into account the qualification and experience of the sub-contractor) should meet the qualification criteria.</p>
H. Public Opening of Financial Parts	
ITB 34.2 (c)	<p>Following the completion of the evaluation of the Technical Parts of the Bids, the Employer will notify all Bidders of the date, time, and location of the public opening of Financial Parts.</p> <p>The online bid opening of Financial Parts of Bids shall take place at:</p> <p>Executive Engineer, Udupi Division, Rural Drinking Water Supply and Sanitation Department (RDWSD),</p>

	<p>Udupi576104 ,UdupiDistrict, Karnataka, India.</p> <p>Date: December 2024</p> <p>Time: to be intimated later</p> <p>[Note: The Financial Parts of the bids shall not be opened earlier than seven (7) days from the communication of technical evaluation results to the bidders]</p> <p>In addition to the above the Employer shall publish a notice of the public opening of the Financial Parts of the Bid on its website RDWSD Karnataka – Official Website (swachhamevajayate.org) and KERS (http://eparihara.aranya.gov.in/kers/public/kshore)</p>
I. Evaluation of Bids - Financial Parts	
ITB 40.2	Provisions related to Abnormally Low Bids do not apply
J. Award of Contract	
ITB 50.1 and 50.2	Not Applicable
ITB 51	<p>The Adjudicator proposed by the Employer is <i>Shri C Gopinatha Rao and</i> has been identified from the list provided by Institution of Engineers (India), holding the membership number of F/16223. The daily fee payable to Adjudicator is Rs. 10,000.</p> <p>The biographical data: Present Position: Retd. Engineer-in-Chief, Water Resource Department, Government of Karnataka Address: "Kausthubha", House No28, AnandaNasar, Vijayanagar Extension, DharwardDist, Hubli – 580 032. Education: BE (Civil) Age: 79 years Nationality: Indian</p> <p>Experience: Worked at various capacities in department of Water Resource, Government of Karnataka for 36 years. Possess wide experience in advisory role for all types of construction projects.</p>

Section III - Evaluation and Qualification Criteria

The Bidder shall provide all the information requested in the forms included in Section IV, Bidding Forms.

1. Technical Part

1.1 Adequacy of Technical Proposal

Evaluation of the Bidder's Technical Proposal will include

(i). an assessment of the Bidder's technical capacity to mobilize key equipment and personnel for the contract consistent with its proposal regarding work methods, scheduling, material sourcing, and quality control/ assurance in sufficient detail and fully in accordance with the requirements stipulated in Section VII, Works' Requirements

For this purpose the Bidder should also submit:

A detailed note outlining its proposed methodology and program of construction including Contractor's Environmental and Social, Health Management Strategies and Implementation Plans (ES-MSIP), backed with equipment, materials and manpower planning and deployment, duly supported with broad calculations and quality control system/assurance procedures proposed to be adopted, justifying their capability of execution and completion of the work as per technical specifications within the stipulated period of completion as per milestones.

(ii) an assessment of the details of subcontracting elements of works amounting to more than 10% of the bid price; for each element proposed to be sub-contracted furnish details whether the identified Sub-contractor possesses the required qualifications and experiences to execute that element satisfactorily. [Work should not be split into small parts and sub-contracted].

(iii) Bidders shall submit an undertaking from each proposed subcontractor to confirm that they have read, understand and will comply with the ES obligations and code of conduct for Contractor's Personnel.

1.2 Alternative Technical Solutions for specified parts of Works(ITB 13.4)– Not Applicable

1.3 Specialized Subcontractors – Not Applicable

2.1 Qualification Criteria

Pursuant to ITB 32.1, the Employer shall assess each Bid against the following Qualification Criteria. Requirements not included in the text below shall not be used in the evaluation of the Bidder's qualifications.

Eligibility and Qualification Criteria			Compliance Requirements			Documentation	
No.	Subject	Requirement	Single Entity	Joint Venture (existing or intended) where permitted			Submissions required
				All members Combined	Each Member	At least one Member	
1. Eligibility							
1.1	Nationality	Nationality in accordance with ITB 4.4	Must meet requirement	N/A	N/A	N/A	Forms ELI – 1.1 and 1.2, with attachments
1.2	Conflict of Interest	No conflicts of interest in accordance with ITB 4.2	Must meet requirement	N/A	N/A	N/A	Letter of Bid
1.3	Bank Eligibility	Not having been declared ineligible by the Bank, as described in ITB 4.5.	Must meet requirement	N/A	N/A	N/A	Letter of Bid
1.4	State-owned enterprise or institution of the Borrower country	Meets conditions of ITB 4.6	Must meet requirement	N/A	N/A	N/A	Forms ELI – 1.1 and 1.2, with attachments
1.5	United Nations resolution or Borrower's country law	Not having been excluded as a result of prohibition in the Borrower's country laws or official regulations against commercial relations with the Bidder's country, or by an act of compliance with UN Security Council resolution, both in accordance with ITB 4.8 and Section V.	Must meet requirement	N/A	N/A	N/A	Forms ELI – 1.1 and 1.2, with attachments
2. Historical Contract Non-Performance							
2.1	History of Non-	Non-performance of a contract ² did not	Must meet	N/A	N/A	N/A	Form CON-2

² Non-performance, as decided by the Employer, shall include all contracts where (a) non-performance was not challenged by the contractor, including through referral to the dispute resolution mechanism under the respective contract, and (b) contracts that were so challenged but fully settled against the contractor.

Non-performance shall not include contracts where Employers decision was overruled by the dispute resolution mechanism. Non-performance must be based on all information on fully settled disputes or litigation, i.e. dispute or litigation that has been resolved in accordance with the dispute resolution mechanism under the respective contract and where all appeal instances available to the Bidder have been exhausted.

Eligibility and Qualification Criteria			Compliance Requirements			Documentation	
No.	Subject	Requirement	Single Entity	Joint Venture (existing or intended) where permitted			Submissions required
				All members Combined	Each Member	At least one Member	
	Performing Contracts	occur as a result of contractor default since 1 st Jan 2019.	requirement ⁷ & ⁸				
2.2	Suspension Based on Execution of Bid/ Proposal Securing Declaration by the Employer or withdrawal of the Bid within Bid validity period	Not under suspension based on execution of a Bid/ Proposal Securing Declaration pursuant to ITB 4.7 or withdrawal of the Bid pursuant ITB 19.9	Must meet requirement	N/A	N/A	N/A	Letter of Bid
2.3	Pending Litigation	Bidder's financial position and prospective long-term profitability sound according to criteria established in 3.1 below and assuming that all pending litigation will be resolved against the Bidder	Must meet requirement	N/A	N/A	N/A	Form CON – 2
2.4	Litigation History	No consistent history of court/arbitral award decisions against the Bidder ³ since 1 st Jan2019	Must meet requirement	N/A	N/A	N/A	Form CON – 2
2.5	Declaration: Environmental and Social (ES) past performance	Declare any civil work contracts that have been suspended or terminated and/or performance security called by an employer for reasons of breach of environmental, or social (including	Must make the declaration. Where there are Specialized	N/A	N/A	N/A	Form CON-3 ES Performance Declaration

³The Bidder shall provide accurate information on the Letter of Bid about any litigation or arbitration resulting from contracts completed or ongoing under its execution over the last five years. A consistent history of court/arbitral awards against the Bidder or any member of a joint venture may result in disqualifying the Bidder.

Eligibility and Qualification Criteria			Compliance Requirements			Documentation	
No.	Subject	Requirement	Single Entity	Joint Venture (existing or intended) where permitted			Submissions required
				All members Combined	Each Member	At least one Member	
		Sexual Exploitation, and Abuse)contractual obligations in the past five years ⁴ .	Sub-contractor/s, the Specialized Sub-contractor/s must also make the declaration.				
3. Financial Situation and Performance							
3.1	Financial Capabilities	(i) The Bidder shall demonstrate that it has access to, or has available, liquid assets, unencumbered real assets, lines of credit ⁵ , and other financial means (independent of any contractual advance payment) sufficient to meet the construction cash flow requirements estimated as Rs. 37.15 lakhs for the subject contract(s) net of the Bidder's other commitments	Must meet requirement	N/A	N/A	N/A	Form FIN – 3.1, with attachments
		(ii) The Bidders shall also demonstrate, to the satisfaction of the Employer, that it has adequate sources of finance to meet the cash flow requirements on works currently in progress and for future contract commitments.	Must meet requirement	N/A	N/A	N/A	

⁴The Employer may use this information to seek further information or clarifications in carrying out its due diligence.

⁵In case the bidder submits a letter of intent from a commercial bank with the bid, firm commitment from the bank to provide line of credit shall be required before contract signing.

Eligibility and Qualification Criteria			Compliance Requirements			Documentation	
No.	Subject	Requirement	Single Entity	Joint Venture (existing or intended) where permitted			Submissions required
				All members Combined	Each Member	At least one Member	
				N/A	N/A	N/A	
		(iii) The audited balance sheets for the last five years shall be submitted and must demonstrate the current soundness of the Bidder's financial position and indicate its prospective long-term profitability.	Must meet requirement	N/A	N/A	N/A	
<i>The cash flow availability should be certified by Bank (Nationalized or Scheduled Bank in India) in Form Fin 3.3</i>							
3.2	Average Annual Construction Turnover	Minimum average annual construction turnover of Rs 272.42 lakhs [In words: Two crore seventy two lakhs and forty two thousand only], calculated as total certified payments received for contracts in progress and/or completed within the last five financial years, divided by five years.	Must meet requirement	N/A	N/A	N/A	Form FIN – 3.2
4. Experience							
4.1 (a)	General Construction Experience	Experience under construction contracts for similar works such as construction of buildings, earthwork, PEB shed, compound wall, concrete road and drain , in the role of prime contractor, JV member, subcontractor, or management contractor for at least the last five years, starting 1 st Jan 2019.	Must meet requirement	N/A	N/A	N/A	Form EXP – 4.1

Eligibility and Qualification Criteria			Compliance Requirements			Documentation	
No.	Subject	Requirement	Single Entity	Joint Venture (existing or intended) where permitted			Submissions required
				All members Combined	Each Member	At least one Member	
4.2 (a)	Specific Construction & Contract Management Experience	(i) A minimum number of similar ⁶ contracts specified below that have been satisfactorily and substantially ⁷ completed as a prime contractor, joint venture member ⁸ , management contractor or sub-contractor ⁹ between 1st Jan 2019 and bid submission deadline: 3 contracts, each of minimum value Rs.108.97 lakhs. similar works with a minimum quantity as given below - Earthwork – 190 cum - Concrete works – 270 cum - Truss Steel – 13.13 ton - GS Sheet – 860 sq.mt	Must meet requirement	N/A	N/A	N/A	Form EXP 4.2(a)
4.2 (c)	Specific Experience in managing ES	For the contracts in 4.2 (a) above and/or any other contracts [substantially completed and under implementation]	Must meet requirements	N/A	N/A	N/A	Form EXP – 4.2 (c)

⁶ Bidder should have completed at least one contract for similar work of value not less than 80% of the estimated contract value of the work for which bids are invited, during the last five years. Cost of completed works of previous years shall be given weightage @5% per year based on rupees value to bring them to the price level of the financial year in which bids are received.

⁷ Substantial completion shall be based on 80% or more works completed under the contract.

⁸ For contracts under which the Bidder participated as a joint venture member or sub-contractor, only the Bidder's share, by value, shall be considered to meet this requirement

⁹ For contracts under which the Bidder participated as a joint venture member or sub-contractor, only the Bidder's share, by value, shall be considered to meet this requirement

Eligibility and Qualification Criteria			Compliance Requirements			Documentation	
No.	Subject	Requirement	Single Entity	Joint Venture (existing or intended) where permitted			Submissions required
				All members Combined	Each Member	At least one Member	
	aspects	as prime contractor, joint venture member, or Subcontractor between 1st Jan2019 and Application submission deadline, experience in managing ES risks and impacts in the <i>Public Health safety, Environment and social aspect</i>					
4.2 (d)	<p>Bid Capacity: Bidders who meet the minimum qualification criteria will be qualified only if their available bid capacity for construction work is equal to or more than the total bid value of the work. The available bid capacity will be calculated as under:</p> <p>Assessed Available bid capacity = $(A*N*1.15-B)$</p> <p>Where,</p> <p>A = Maximum value of civil engineering works executed in any one year during the last five years (updated to the price level of the financial year 2023-24 at the rate of 5% per year), taking into account the completed as well as works in progress).</p> <p>N = Number of years prescribed for completion of the works for which bids are invited (period upto 6 months to be taken as half-year and more than 6 months as one year).</p> <p>B = Value, at the current price level, of existing commitments on on-going works to be completed during the period of completion of the works for which bids are invited.</p> <p>Note: the statements in Section IV showing the value of existing commitments of on-going works as well as the stipulated period of completion remaining for each of the works listed should be countersigned by the Engineer in charge, not below the rank of an Executive Engineer or equivalent.</p>						

3. Key Personnel

The Bidder must demonstrate that it will have suitably qualified (and in adequate numbers) minimum Key Personnel, as described in the Table below, that are required to perform the Contract.

The Bidder shall provide details of the Key Personnel and such other Key Personnel that the Bidder considers appropriate, together with their academic qualifications and work experience. The Bidder shall complete the relevant Forms in Section IV, Bidding Forms.

The Contractor shall require the Employer's consent to substitute or replace the Key Personnel (reference the Particular Conditions of Contract 9.1).

Key Personnel

Item No.	Position/ specialization	Relevant academic qualifications	Minimum years of relevant work experience
1	Project Engineer – 1 no.	Masters or Bachelor's in civil engineering	8 years of experience with a master's degree or 10 years of experience with a bachelor's degree, specifically in managing at least four projects as a Project Manager. Each project should have a minimum value of ₹3 crore.
2	Site Engineer – 1 no.	Diploma in Civil Engineering	8 years of experience as a Site Engineer, with a track record of successfully managing at least 5 projects.
<u>Suitable experts in the following specializations</u>			
3	EnvironmentalExpert	Master's in environmental engineering	5 years of experience in monitoring environmental aspectsfor construction projects.
4	Health and SafetySpecialist	Diploma/Degree in Occupational Health and Safety or other stream with certification in Health and Safety	5 years of experience monitoring Health and Safety aspects for construction projects.

The Bidder must not have in his employment:

- [i] the near relations (defined as first blood relations, and their spouses, of the bidder or the bidder's spouse) of persons of the Rural Development and Panchayat Raj Department, GoK.
- [ii] without Government permission, any person who retired as gazetted officer within the last two years.

4. Equipment

The Bidder must demonstrate that it will have access to the key Contractor's equipment listed hereafter:

No.	Equipment Type and Characteristics	Minimum Number required
1	<i>Excavators with necessary accessories (e.g., buckets, thumbs)</i>	1
2	<i>Loading/dump Trucks (for transporting materials; capacity of 10-15 tons)</i>	2
3	<i>Concrete Mixers (transit mixer or stationary mixer)</i>	1
4	<i>Compactors/Rollers/vibrator (for soil and asphalt compaction)</i>	1
5	<i>Water Tankers (for dust suppression and mixing concrete)</i>	1

Please Note:

- 1) The bidder should arrange all necessary equipments required for the proper and timely execution of the work. Nothing extra shall be paid on this account.
- 2) No tools and plants including any special Tools & Plants etc. shall be supplied by the Department and the contractor shall have to make his own arrangements at his own cost. No claim of hindrance (or any other claim) shall be entertained on this account.
- 3) The agency may deploy adequate equipment, machinery and labour as required for the completion of the entire work within the stipulated period specified. Also, ancillary facilities shall be provided by contractor commensurate with requirement to complete the entire work within the stipulated period. Nothing extra shall be payable on this account. Adequate number/sets of equipment in working condition, along with adequate stand-by arrangements, shall be deployed during entire work period. It shall be ensured by the Contractor that all the equipment, Tools & Plants, machineries etc. provided by him are maintained in proper working conditions at all times during the progress of the work and till the completion of the work.

[NOTE: Based on the studies carried out by the Project Manager the minimum suggested major equipment to attain the completion of works in accordance with the prescribed construction schedule is shown in the above list. The bidders should, however, undertake their own studies and furnish with their bid, a detailed construction planning and methodology supported with layout and necessary drawings and calculations (detailed) as stated in Section IV to allow the employee to review their proposals. The numbers, types and capacities of each plant/equipment shall be shown in the proposals along with the cycle time for each operation for the given production capacity to match the requirements.]

The Bidder shall provide further details of proposed items of equipment using the relevant Form in Section IV.

5. Multiple Contracts*Not Applicable*

2. Financial Part

2.1 Margin of Preference - Not Applicable

2.2 Multiple Contracts– Not Applicable

2.3 Sustainable procurement(Section VII - Specifications) – Not Applicable

2.4 Alternative Completion Times (ITB 13.2)- Not Applicable

2.5 Alternative Technical Solutions for specified parts of the Works (ITB 13.4)- Not Applicable

2.6 Other criteria– Not Applicable

Section IV - Bidding Forms

Letter of Bid – Technical Part

INSTRUCTIONS TO BIDDERS: DELETE THIS BOX ONCE YOU HAVE COMPLETED THE DOCUMENT

The Bidder must prepare this Letter of Bid on stationery with its letterhead clearly showing the Bidder's complete name and business address.

Note: All italicized text is to help Bidders in preparing this form.

Date of this Bid submission: *[insert date (as day, month and year) of Bid submission]*

RFB No.: *[insert number of RFB process]*

Alternative No¹: *[insert identification No. if this is a Bid for an alternative]*

To: *[insert complete name of Employer]*

We, the undersigned, hereby submit our Bid, in two parts, namely:

- (a) the Technical Part, and
- (b) the Financial Part

In submitting our Bid, we make the following declarations:

- (a) **No reservations:** We have examined and have no reservations to the bidding document, including Addenda issued in accordance with ITB 8;
- (b) **Eligibility:** We meet the eligibility requirements and have no conflict of interest in accordance with ITB 4;
- (c) **Bid-Securing Declaration:** We havenot been suspended nor declared ineligible by the Employer based on execution of a Bid-Securing Declaration or Proposal-Securing Declaration in the Employer's Country in accordance with ITB 4.7
- (d) **Conformity:** We offer to execute in conformity with the bidding document the following Works: *[insert a brief description of the Works]*
- (e) **Bid Validity Period:** Our Bid shall be valid for a period specified in BDS ITB 18.1 (or as amended if applicable) from the date fixed for the Bid submission deadline specified in BDS 22.1 (or as amended if applicable), and it shall remain binding upon us and may be accepted at any time before the expiration of that period;

¹ Delete if not applicable

- (f) **Performance Security:** If our Bid is accepted, we commit to obtain a performance security [*and an Environmental and Social (ES) Performance Security, Delete if not applicable*] in accordance with the bidding document;
- (g) **One Bid Per Bidder:** We are not submitting any other Bid(s) as an individual Bidder or as a subcontractor, and we are not participating in any other Bid(s) as a Joint Venture member, and meet the requirements of ITB 4.3, other than alternative Bids submitted in accordance with ITB 13;
- (h) **Suspension and Debarment:** We, along with any of our subcontractors, suppliers, consultants, manufacturers, or service providers for any part of the contract, are not subject to, and not controlled by any entity or individual that is subject to, a temporary suspension or a debarment imposed by the World Bank Group or a debarment imposed by the World Bank Group in accordance with the Agreement for Mutual Enforcement of Debarment Decisions between the World Bank and other development banks. Further, we are not ineligible under the Employer's Country laws or official regulations or pursuant to a decision of the United Nations Security Council;
- (i) **State-owned enterprise or institution:** We are not a state-owned enterprise or institution/ We are a state-owned enterprise or institution but meet the requirements of ITB 4.6²;
- (j) **Binding Contract:** We understand that this Bid, together with your written acceptance thereof included in your Letter of Acceptance, shall constitute a binding contract between us, until a formal contract is prepared and executed;
- (k) **Not Bound to Accept:** We understand that you are not bound to accept the lowest evaluated cost Bid, the Most Advantageous Bid or any other Bid that you may receive; and
- (l) **Fraud and Corruption:** We hereby certify that we have taken steps to ensure that no person acting for us or on our behalf engages in any type of Fraud and Corruption; and
- (m) **Adjudicator:** We accept the appointment of [*insert name proposed in Bid Data Sheet*] as the Adjudicator.

[or]

We do not accept the appointment of [*insert name proposed in Bid Data Sheet*] as the Adjudicator, and propose instead that [*insert name*] be appointed³ as Adjudicator, whose daily fees and biographical data are attached.

Name of the Bidder: **[insert complete name of person signing the Bid]*

²Use one of the two options as appropriate

³ In case appointment of Adjudicator was proposed from the list provided by an Institution in ITB 51, the replacement should also be proposed from the list of same institution.

Name of the person duly authorized to sign the Bid on behalf of the Bidder:***[insert complete name of person duly authorized to sign the Bid]*

Title of the person signing the Bid: *[insert complete title of the person signing the Bid]*

Signature of the person named above: *[insert signature of person whose name and capacity are shown above]*

Date signed*[insert date of signing]* **day of** *[insert month]*, *[insert year]*

*: In the case of the Bid submitted by joint venture specify the name of the Joint Venture as Bidder

** : Person signing the Bid shall have the power of attorney given by the Bidder to be attached with the Bid

Technical Proposal

Technical Proposal Forms

(Mention the title in a separate annexure)

- **Key Personnel Schedule**
- **Equipment**
- **Site Organization**
- **Method Statement**
- **Mobilization Schedule**
- **Construction Schedule**
- **ES Management Strategies and Implementation Plans**
- **Code of Conduct for Contractor's Personnel (ES)**
- **Sub-contracting elements or works which in aggregate adds to more than 10% of Bid price (for each the qualifications and experiences on the identified subcontractor in the relevant field should be given)**

Note: Work should not be split into small parts and sub-contracted; but sub-contracting specialized elements of works is acceptable.

- **Others**
- **Bidder's Qualification**
- **Form of Bid Security - Bank Guarantee**
- **Form of Bid-Securing Declaration**

Appendix to Technical Part: Personnel
Forms for Personnel
(Mention the title in a separate annexure)

Form PER – 1: Key Personnel Schedule

Bidders should provide the names and details of the suitably qualified Key Personnel to perform the Contract. The data on their experience should be supplied using the Form PER-2 below for each candidate.

Key Personnel

1.	Title of position:	
	Name of candidate:	
	Duration of appointment:	<i>[insert the whole period (start and end dates) for which this position will be engaged]</i>
	Time commitment for this position:	<i>[insert the number of days/week/months/ that has been scheduled for this position]</i>
	Expected time schedule for this position:	<i>[insert the expected time schedule for this position (e.g. attach high level Gantt chart)]</i>
2.	Title of position: <i>[Environmental Specialist]</i>	
	Name of candidate:	
	Duration of appointment:	<i>[insert the whole period (start and end dates) for which this position will be engaged]</i>
	Time commitment for this position:	<i>[insert the number of days/week/months/ that has been scheduled for this position]</i>
	Expected time schedule for this position:	<i>[insert the expected time schedule for this position (e.g. attach high level Gantt chart)]</i>
3.	Title of position: <i>[Health and Safety Specialist]</i>	
	Name of candidate:	
	Duration of appointment:	<i>[insert the whole period (start and end dates) for which this position will be engaged]</i>
	Time commitment for this position:	<i>[insert the number of days/week/months/ that has been scheduled for this position]</i>
	Expected time schedule for this position:	<i>[insert the expected time schedule for this position (e.g. attach high level Gantt chart)]</i>

4.	Title of position: <i>[Social Specialist]</i>	
	Name of candidate:	
	Duration of appointment:	<i>[insert the whole period (start and end dates) for which this position will be engaged]</i>
	Time commitment for this position:	<i>[insert the number of days/week/months/ that has been scheduled for this position]</i>
	Expected time schedule for this position:	<i>[insert the expected time schedule for this position (e.g. attach high level Gantt chart)]</i>
5.	Title of position: <i>[Where a Project SEA risks are assessed to be substantial or high, Key Personnel shall include an expert with relevant experience in addressing sexual exploitation, sexual abuse and sexual harassment cases]</i>	
	Name of candidate:	
	Duration of appointment:	<i>[insert the whole period (start and end dates) for which this position will be engaged]</i>
	Time commitment for this position:	<i>[insert the number of days/week/months/ that has been scheduled for this position]</i>
	Expected time schedule for this position:	<i>[insert the expected time schedule for this position (e.g. attach high level Gantt chart)]</i>
6.	Title of position:	
	Name of candidate	
	Duration of appointment:	<i>[insert the whole period (start and end dates) for which this position will be engaged]</i>
	Time commitment for this position:	<i>[insert the number of days/week/months/ that has been scheduled for this position]</i>
	Expected time schedule for this position:	<i>[insert the expected time schedule for this position (e.g. attach high level Gantt chart)]</i>

Appendix to Technical Part

Form PER-2:

Resume and Declaration (Mention the title in a separate annexure)

Key Personnel

Name of Bidder

Position [#1]: <i>[title of position from Form PER-1]</i>											
Personnel information	<table border="1" style="width: 100%; border-collapse: collapse;"> <tr> <td style="width: 40%; padding: 5px;">Name:</td> <td style="padding: 5px;">Date of birth:</td> </tr> <tr> <td style="padding: 5px;">Address:</td> <td style="padding: 5px;">E-mail:</td> </tr> <tr> <td colspan="2" style="padding: 5px;">Professional qualifications:</td> </tr> <tr> <td colspan="2" style="padding: 5px;">Academic qualifications:</td> </tr> <tr> <td colspan="2" style="padding: 5px;">Language proficiency:<i>[language and levels of speaking, reading and writing skills]</i></td> </tr> </table>	Name:	Date of birth:	Address:	E-mail:	Professional qualifications:		Academic qualifications:		Language proficiency: <i>[language and levels of speaking, reading and writing skills]</i>	
Name:	Date of birth:										
Address:	E-mail:										
Professional qualifications:											
Academic qualifications:											
Language proficiency: <i>[language and levels of speaking, reading and writing skills]</i>											
details	<table border="1" style="width: 100%; border-collapse: collapse;"> <tr> <td colspan="2" style="padding: 5px;">Address of employer:</td> </tr> <tr> <td style="width: 40%; padding: 5px;">Telephone:</td> <td style="padding: 5px;">Contact (manager / personnel officer):</td> </tr> <tr> <td style="padding: 5px;">Fax:</td> <td style="padding: 5px;"></td> </tr> <tr> <td style="padding: 5px;">Job title:</td> <td style="padding: 5px;">Years with present employer:</td> </tr> </table>	Address of employer:		Telephone:	Contact (manager / personnel officer):	Fax:		Job title:	Years with present employer:		
Address of employer:											
Telephone:	Contact (manager / personnel officer):										
Fax:											
Job title:	Years with present employer:										

Summarize professional experience in reverse chronological order. Indicate particular technical and managerial experience relevant to the project.

Project	Role	Duration of involvement [From - To]	Relevant experience

<i>[main project details]</i>	<i>[role and responsibilities on the project]</i>	<i>[time in role]</i>	<i>[describe the experience relevant to this position]</i>

Declaration

I, the undersigned Key Personnel, certify that to the best of my knowledge and belief, the information contained in this Form PER-2 correctly describes myself, my qualifications and my experience.

I confirm that I am available as certified in the following table and throughout the expected time schedule for this position as provided in the Bid:

Commitment	Details
Commitment to duration of contract:	<i>[insert period (start and end dates) for which this Key Personnel is available to work on this contract]</i>
Time commitment:	<i>[insert the number of days/week/months/ that this Key Personnel will be engaged]</i>

I understand that any misrepresentation or omission in this Form may:

- (a) be taken into consideration during Bid evaluation;
- (b) result in my disqualification from participating in the Bid;
- (c) result in my dismissal from the contract.

Name of Key Personnel: *[insert name]*

Signature: _____

Date: (day month year): _____

Countersignature of authorized representative of the Bidder:

Signature: _____

Date: (day month year): _____

Appendix to Technical Part: Equipment
Forms for Equipment
(Mention the title in a separate annexure)

The Bidder shall provide adequate information to demonstrate clearly that it has the capability to meet the requirements for the key equipment listed in Section III (Evaluation and Qualification Criteria). A separate Form shall be prepared for each item of equipment listed, or for alternative equipment proposed by the Bidder. The Bidder shall provide all the information requested below, to the extent possible. Fields with asterisk (*) shall be used for evaluation.

Type of Equipment*	
Equipment Information	Name of manufacturer,
	Capacity*
	Model and power rating
	Year of manufacture*
Current Status	Current location
	Details of current commitments
Source	Indicate source of the equipment <input type="checkbox"/> Owned <input type="checkbox"/> Rented <input type="checkbox"/> Leased <input type="checkbox"/> Specially manufactured

The following information shall be provided only for equipment not owned by the Bidder.

Owner	Name of owner	
	Address of owner	
	Telephone	Contact name and title
	Fax	Telex
Agreements	Details of rental / lease / manufacture agreements specific to the project	

Appendix to Technical Part

Site Organization

[insert Site Organization information]

(Mention the title in a separate annexure)

Appendix to Technical Part
(Mention the title in a separate annexure)

Method Statement

[insert method Statement – A detailed note should be submitted outlining bidders proposed methodology and program of construction including Contractor’s Environmental and Social, Health Management Strategies and Implementation Plans (ES-MSIP), backed with equipment, materials and manpower planning and deployment, duly supported with broad calculations and quality control system/assurance procedures proposed to be adopted, justifying their capability of execution and completion of the work as per technical specifications within the stipulated period of completion as per milestones]

Appendix to Technical Part
(Mention the title in a separate annexure)

Mobilization Schedule

[insert Mobilization Schedule]

In accordance with the Particular Conditions, Sub-Clause 16.2, the Contractor shall not carry out mobilization to Site unless the Project manager gives consent that appropriate measures are in place to address environmental and social risks and impacts, which as a minimum shall include applying the Management Strategies and Implementation Plans (MSIPs) and Code of Conduct for Contractor's Personnel, submitted as part of the Bid and agreed as part of the Contract.

Appendix to Technical Part
(Mention the title in a separate annexure)

Construction Schedule

[insert Construction Schedule]

The construction schedule shall include the following key milestone - No-objection to the Code of Conduct for Contractor's Personnel and Contractor's MSIPs, which collectively form the C-ESMP, in accordance with the Particular Conditions of Contract Sub-Clause 16.2.

Appendix to Technical Part

(Mention the title in a separate annexure)

Environmental and Social, Health Management Strategies and Implementation Plans

(ES-MSIP)

The Bidder shall submit comprehensive and concise Environmental and Social Management Strategies and Implementation Plans (ES-MSIP) as required by ITB 11.2 (j) of the Bid Data Sheet. These strategies and plans shall describe in detail the actions, materials, equipment, management processes etc. that will be implemented by the Contractor, and its subcontractors.

In developing these strategies and plans, the Bidder shall have regard to the ES provisions of the contract including those as may be more fully described in the Works Requirements in Section VII.

Appendix to Technical Part
(Mention the title in a separate annexure)

Code of Conduct for Contractor's Personnel (ES) Form

Note to the Bidder:

The minimum content of the Code of Conduct form as set out by the Employer shall not be substantially modified. However, the Bidder may add requirements as appropriate, including to take into account Contract-specific issues/risks.

The Bidder shall initial and submit the Code of Conduct form as part of its bid.

CODE OF CONDUCT FOR CONTRACTOR'S PERSONNEL

We are the Contractor, [*enter name of Contractor*]. We have signed a contract with [*enter name of Employer*] for [*enter description of the Works*]. These Works will be carried out at [*enter the Site and other locations where the Works will be carried out*]. Our contract requires us to implement measures to address environmental and social risks related to the Works, including the risks of sexual exploitation, sexual abuse and sexual harassment.

This Code of Conduct is part of our measures to deal with environmental and social risks related to the Works. It applies to all our staff, laborers and other employees at the Works Site or other places where the Works are being carried out. It also applies to the personnel of each subcontractor and any other personnel assisting us in the execution of the Works. All such persons are referred to as “**Contractor's Personnel**” and are subject to this Code of Conduct.

This Code of Conduct identifies the behavior that we require from all Contractor's Personnel.

Our workplace is an environment where unsafe, offensive, abusive or violent behavior will not be tolerated and where all persons should feel comfortable raising issues or concerns without fear of retaliation.

REQUIRED CONDUCT

Contractor's Personnel shall:

1. carry out his/her duties competently and diligently;

2. comply with this Code of Conduct and all applicable laws, regulations and other requirements, including requirements to protect the health, safety and well-being of other Contractor's Personnel and any other person;
3. maintain a safe working environment including by:
 - a. ensuring that workplaces, machinery, equipment and processes under each person's control are safe and without risk to health;
 - b. wearing required personal protective equipment;
 - c. using appropriate measures relating to chemical, physical and biological substances and agents; and
 - d. following applicable emergency operating procedures.
4. report work situations that he/she believes are not safe or healthy and remove himself/herself from a work situation which he/she reasonably believes presents an imminent and serious danger to his/her life or health;
5. treat other people with respect, and not discriminate against specific groups such as women, people with disabilities, migrant workers or children;
6. not engage in Sexual Harassment, which means unwelcome sexual advances, requests for sexual favors, and other verbal or physical conduct of a sexual nature with other Contractor's or Employer's Personnel;
7. not engage in Sexual Exploitation, which means any actual or attempted abuse of position of vulnerability, differential power or trust, for sexual purposes, including, but not limited to, profiting monetarily, socially or politically from the sexual exploitation of another;
8. not engage in Sexual Abuse, which means the actual or threatened physical intrusion of a sexual nature, whether by force or under unequal or coercive conditions;
9. not engage in any form of sexual activity with individuals under the age of 18, except in case of pre-existing marriage;
10. complete relevant training courses that will be provided related to the environmental and social aspects of the Contract, including on health and safety matters, and Sexual Exploitation, and Abuse (SEA) and Sexual Harassment (SH);
11. report violations of this Code of Conduct; and
12. not retaliate against any person who reports violations of this Code of Conduct, whether to us or the Employer, or who makes use of the grievance mechanism for Contractor's Personnel or the project's Grievance Redress Mechanism.

RAISING CONCERNS

If any person observes behavior that he/she believes may represent a violation of this Code of Conduct, or that otherwise concerns him/her, he/she should raise the issue promptly. This can be done in either of the following ways:

1. Contact [*enter name of the Contractor's Social Expert with relevant experience in handling gender-based violence, or if such person is not required under the Contract,*

another individual designated by the Contractor to handle these matters] in writing at this address [] or by telephone at [] or in person at []; or

2. Call [] to reach the Contractor's hotline (*if any*) and leave a message.

The person's identity will be kept confidential, unless reporting of allegations is mandated by the country law. Anonymous complaints or allegations may also be submitted and will be given all due and appropriate consideration. We take seriously all reports of possible misconduct and will investigate and take appropriate action. We will provide warm referrals to service providers that may help support the person who experienced the alleged incident, as appropriate.

There will be no retaliation against any person who raises a concern in good faith about any behavior prohibited by this Code of Conduct. Such retaliation would be a violation of this Code of Conduct.

CONSEQUENCES OF VIOLATING THE CODE OF CONDUCT

Any violation of this Code of Conduct by Contractor's Personnel may result in serious consequences, up to and including termination and possible referral to legal authorities.

FOR CONTRACTOR'S PERSONNEL:

I have received a copy of this Code of Conduct written in a language that I comprehend. I understand that if I have any questions about this Code of Conduct, I can contact [*enter name of Contractor's contact person with relevant experience*] requesting an explanation.

Name of Contractor's Personnel: [insert name]

Signature: _____

Date: (day month year): _____

Countersignature of authorized representative of the Contractor:

Signature: _____

Date: (day month year): _____

ATTACHMENT 1: Behaviors constituting Sexual Exploitation and Abuse (SEA) and behaviors constituting Sexual Harassment (SH)

ATTACHMENT 1 TO THE CODE OF CONDUCT FORM
BEHAVIORS CONSTITUTING SEXUAL EXPLOITATION AND ABUSE (SEA) AND
BEHAVIORS CONSTITUTING SEXUAL HARASSMENT (SH)

The following non-exhaustive list is intended to illustrate types of prohibited behaviors:

(1) Examples of sexual exploitation and abuse include, but are not limited to:

- A Contractor's Personnel tells a member of the community that he/she can get them jobs related to the work site (e.g. cooking and cleaning) in exchange for sex.
- A Contractor's Personnel that is connecting electricity input to households says that he can connect women headed households to the grid in exchange for sex.
- A Contractor's Personnel rapes, or otherwise sexually assaults a member of the community.
- A Contractor's Personnel denies a person access to the Site unless he/she performs a sexual favor.
- A Contractor's Personnel tells a person applying for employment under the Contract that he/she will only hire him/her if he/she has sex with him/her.

(2) Examples of sexual harassment in a work context

- Contractor's Personnel comment on the appearance of another Contractor's Personnel (either positive or negative) and sexual desirability.
- When a Contractor's Personnel complains about comments made by another Contractor's Personnel on his/her appearance, the other Contractor's Personnel comment that he/she is "asking for it" because of how he/she dresses.
- Unwelcome touching of a Contractor's or Employer's Personnel by another Contractor's Personnel.
- A Contractor's Personnel tells another Contractor's Personnel that he/she will get him/her a salary raise, or promotion if he/she sends him/her naked photographs of himself/herself.

Others

Appendix to Technical Part
(Mention the title in a separate annexure)

Sub-Contracting

SCHEDULE OF SUBCONTRACTORS

Item	Element of work	% of bid price	Name and address of sub-contractor	Qualification and experience of sub-contractor on similar works of the elements executed

The Bidder shall enter in this schedule a list of the major sections and appropriate value of the work for which he proposed to use subcontractors [*for those costing more than 10% of the bid price for each element*], together with the names, addresses and experiences of the proposed subcontractors.

The capability of the sub-contractor will also be assessed (on the same lines as for the main Contractor) before according approval to him.

(Work should not be split into small parts and sub-contracted; but sub-contracting specialized elements of works is acceptable).

Appendix to Technical Part

Others

(Mention the title in a separate annexure)

Appendix to Technical Part

Bidder's Qualification

(Mention the title in a separate annexure)

To establish its qualifications to perform the contract in accordance with Section III (Evaluation and Qualification Criteria) the Bidder shall provide the information requested in the corresponding Information Sheets included hereunder

Appendix to Technical Part

Form ELI -1.1: Bidder Information Form

(Mention the title in a separate annexure)

Date: _____
RFB No. and title: _____
Page _____ of _____ pages

Bidder's legal name
In case of Joint Venture (JV), legal name of each member:
Bidder's actual or intended country of registration: <i>[indicate country of Constitution]</i>
Bidder's actual or intended year of incorporation:
Bidder's legal address [in country of registration]:
<p>Bidder's authorized representative information</p> Name: _____ Address: _____ Telephone/Fax numbers: _____ E-mail address: _____
<p>1. Attached are copies of original documents of</p> <input type="checkbox"/> Articles of Incorporation (or equivalent documents of constitution or association), and/or documents of registration of the legal entity named above, in accordance with ITB 4.4. <input type="checkbox"/> Authorization to represent the firm or JV named in above, in accordance with ITB 20. <input type="checkbox"/> In case of JV, letter of intent to form JV or JV agreement, in accordance with ITB 4.1. <input type="checkbox"/> In case of state-owned enterprise or institution, in accordance with ITB 4.6 documents establishing: <ul style="list-style-type: none"> • Legal and financial autonomy • Operation under commercial law • Establishing that the Bidder is not under the supervision of the Employer
2. Included are the organizational chart, a list of Board of Directors, and the beneficial

ownership.

Appendix to Technical Part
Form ELI -1.2: Information Form for JV Bidders
(Mention the title in a separate annexure – Not Applicable)

(Where permitted as per BDS ITB 4.1)
 (to be completed for each member of Joint Venture)

Date: _____
 RFB No. and title: _____
 Page _____ of _____ pages

JV Information
Bidder's Joint Venture legal name:
JV member's legal name:
JV member's country of registration:
JV member's year of constitution:
JV member's legal address in country of constitution:
JV member's authorized representative information Name: _____ Address: _____ Telephone/Fax numbers: _____ E-mail address: _____
1. Attached are copies of original documents of <ul style="list-style-type: none"> <input type="checkbox"/> Articles of Incorporation (or equivalent documents of constitution or association), and/or registration documents of the legal entity named above, in accordance with ITB 4.4. <input type="checkbox"/> Authorization to represent the firm or JV named in above, in accordance with ITB 20. <input type="checkbox"/> In case of a state-owned enterprise or institution, documents establishing legal and financial autonomy, operation in accordance with commercial law, and is not under the supervision of the Employer, in accordance with ITB 4.6. 2. Included are the organizational chart, a list of Board of Directors, and the beneficial ownership.

Appendix to Technical Part

Form ELI -1.2 A

Specialized Subcontractor's Information Form

(Mention the title in a separate annexure – Not Applicable)

(to be completed for each Specialized Subcontractor)

Appendix to Technical Part
(Mention the title in a separate annexure)

Not Applicable

DETAILS OF PARTICIPATION IN THE JOINT VENTURE

PARTICIPATION DETAILS	FIRM 'A' (Lead Member)	FIRM 'B'	FIRM 'C'
Financial			
Name of the Banker(s)			
Planning			
Construction Equipment			
Key Personnel			
Execution of Work (Give details on proposed contribution of each)			

The Joint Venture should indicate the details of participation as above.

Appendix to Technical Part

**Form CON – 2: Historical Contract Non-Performance, Pending
Litigation and Litigation History**

(Mention the title in a separate annexure)

[to be completed for the Bidder and for each member of a Joint Venture]

Bidder's Name: _____

Date: _____

Joint Venture Member's Name _____

RFB No. and title: _____

Page _____ of _____ pages

Non-Performed Contracts in accordance with Section III, Evaluation and Qualification Criteria			
<input type="checkbox"/> Contract non-performance did not occur since 1 st January <i>[insert year]</i> specified in Section III, Evaluation and Qualification Criteria, Sub-Factor 2.1.			
<input type="checkbox"/> Contract(s) not performed since 1 st January <i>[insert year]</i> specified in Section III, Evaluation and Qualification Criteria, requirement 2.1			
Year	Non-performed portion of contract	Contract Identification	Total Contract Amount (Rs.)
<i>[insert year]</i>	<i>[insert amount and percentage]</i>	Contract Identification: <i>[indicate complete contract name/ number, and any other identification]</i> Name of Employer: <i>[insert full name]</i> Address of Employer: <i>[insert street/city/country]</i> Reason(s) for non-performance: <i>[indicate main reason(s)]</i>	<i>[insert amount]</i>
Pending Litigation, in accordance with Section III, Evaluation and Qualification Criteria			
<input type="checkbox"/> No pending litigation in accordance with Section III, Evaluation and Qualification Criteria, Sub-Factor 2.3.			
<input type="checkbox"/> Pending litigation in accordance with Section III, Evaluation and Qualification Criteria, Sub-Factor 2.3 as indicated below.			

Year of dispute	Amount in dispute (Rs.)	Contract Identification	Total Contract Amount (Rs.)
<i>[insert year]</i>	<i>[insert amount]</i>	Contract Identification: [indicate complete contract name, number, and any other identification] Name of Employer: <i>[insert full name]</i> Address of Employer: <i>[insert street/city/country]</i> Matter in dispute: <i>[indicate main issues in dispute]</i> Party who initiated the dispute: <i>[indicate "Employer" or "Contractor"]</i> Status of dispute: <i>[Indicate if it is being treated by the Adjudicator, under Arbitration or being dealt with by the Judiciary]</i>	<i>[insert amount]</i>
<i>[insert year]</i>	<i>[insert amount]</i>	Contract Identification: [indicate complete contract name, number, and any other identification] Name of Employer: <i>[insert full name]</i> Address of Employer: <i>[insert street/city/country]</i> Matter in dispute: <i>[indicate main issues in dispute]</i> Party who initiated the dispute: <i>[indicate "Employer" or "Contractor"]</i> Status of dispute: <i>[Indicate if it is being treated by the Adjudicator, under Arbitration or being dealt with by the Judiciary]</i>	<i>[insert amount]</i>
Litigation History in accordance with Section III, Evaluation and Qualification Criteria			
<input type="checkbox"/> No Litigation History in accordance with Section III, Evaluation and Qualification Criteria, Sub-Factor 2.4. <input type="checkbox"/> Litigation History in accordance with Section III, Evaluation and Qualification Criteria, Sub-Factor 2.4 as indicated below.			

Year of award	Outcome as percentage of Net Worth	Contract Identification	Total Contract Amount (Rs.)
<i>[insert year]</i>	<i>[insert percentage]</i>	Contract Identification: [indicate complete contract name, number, and any other identification] Name of Employer: <i>[insert full name]</i> Address of Employer: <i>[insert street/city/country]</i> Matter in dispute: <i>[indicate main issues in dispute]</i> Party who initiated the dispute: <i>[indicate "Employer" or "Contractor"]</i> Reason(s) for Litigation and award decision <i>[indicate main reason(s)]</i>	<i>[insert amount]</i>

Appendix to Technical Part
(Mention the title in a separate annexure)

Form CON – 3: Environmental and Social(ES) Performance Declaration

[The following table shall be filled in for the Bidder, each member of a Joint Venture and each Specialized Subcontractor]

Bidder's Name: _____ *[insert full name]*
Date: _____ *[insert day, month, year]*
Joint Venture Member's or Specialized Subcontractor's Name: _____ *[insert full name]*
RFB No. and title: _____ *[insert RFB number and title]*
Page _____ *[insert page number]* of _____ *[insert page number]* pages

Environmental and Social Performance Declaration in accordance with Section III, Qualification Criteria, and Requirements			
<input type="checkbox"/> No suspension or termination of contract: An employer has not suspended or terminated a contract and/or called the performance security for a contract for reasons related to Environmental or Social (ES) performance since the date specified in Section III, Qualification Criteria, and Requirements, Sub-Factor 2.5.			
<input type="checkbox"/> Declaration of suspension or termination of contract: The following contract(s) has/have been suspended or terminated and/or Performance Security called by an employer(s) for reasons related to Environmental or Social (ES) performance since the date specified in Section III, Qualification Criteria, and Requirements, Sub-Factor 2.5. Details are described below:			
Year	Suspended or terminated portion of contract	Contract Identification	Total Contract Amount (Rs.)
<i>[insert year]</i>	<i>[insert amount and percentage]</i>	Contract Identification: <i>[indicate complete contract name/ number, and any other identification]</i> Name of Employer: <i>[insert full name]</i> Address of Employer: <i>[insert street/city/country]</i> Reason(s) for suspension or termination: <i>[indicate main reason(s) e.g.forgender-based violence; sexual exploitation or sexual abusebreaches]</i>	<i>[insert amount]</i>
<i>[insert year]</i>	<i>[insert amount and percentage]</i>	Contract Identification: <i>[indicate complete contract name/ number, and any other identification]</i>	<i>[insert amount]</i>

		Name of Employer: <i>[insert full name]</i> Address of Employer: <i>[insert street/city/country]</i> Reason(s) for suspension or termination: <i>[indicate main reason(s)]</i>	
...	...	<i>[list all applicable contracts]</i>	...
Performance Security called by an employer(s) for reasons related to ES performance			
Year	Contract Identification		Total Contract Amount (Rs.)
<i>[insert year]</i>	Contract Identification: <i>[indicate complete contract name/ number, and any other identification]</i> Name of Employer: <i>[insert full name]</i> Address of Employer: <i>[insert street/city/country]</i> Reason(s) for calling of performance security: <i>[indicate main reason(s) e.g. for gender-based violence; sexual exploitation or sexual abuse breaches]</i>		<i>[insert amount]</i>

Appendix to Technical Part

Form CCC: Current Contract Commitments / Works in Progress

(Mention the title in a separate annexure)

Bidders and each member of a JV should provide information on their current commitments on all contracts that have been awarded, or for which a letter of intent or acceptance has been received, or for contracts approaching completion, but for which an unqualified, full completion certificate has yet to be issued.

(A) :

Description of Work	Place & State	Contract No. & Date	Name and Address of Employer	Value of Contract (Rs. equivalent in million)	Stipulated period of completion	Value of works ¹ remaining to be completed (Rs. equivalent in million)	Anticipated date of completion	Average Monthly Invoicing Over Last Six Months (Rs./month) Equivalent in millions)
(1)	(2)	(3)	(4)	(5)	(6)	(7)	(8)	(9)

¹Attach certificate(s) from the Engineer(s)-in-Charge.

(B) Works for which bids already submitted and likely to be awarded – expected additional commitment.

Description of Work	Place & State	Name and Address of Employer	Estimated value of Works (Rs. equivalent in million)	Stipulated period of completion	Date when decision is expected	Remarks, if any
(1)	(2)	(3)	(4)	(5)	(6)	(7)

Appendix to Technical Part

(Mention the title in a separate annexure)

Form FIN – 3.1: Financial Situation and Performance

[To be completed by the Bidder and by each member of a Joint Venture]

Bidder's Legal Name: _____

Date: _____

Joint Venture Member's Legal Name _____

RFB No. and title: _____

Page _____ of _____ pages

1. Financial data

Type of Financial information in (Rs.)	Historic information for previous _____ years, <hr style="width: 20%; margin: 0 auto;"/> (amount in Rs.)				
	Year 1	Year 2	Year 3	Year 4	Year 5
Statement of Financial Position (Information from Balance Sheet)					
Total Assets (TA)					
Total Liabilities (TL)					
Total Equity/Net Worth (NW)					
Current Assets (CA)					
Current Liabilities (CL)					
Working Capital (WC)					
Information from Income Statement					
Total Revenue (TR)					
Profits Before Taxes (PBT)					

Cash Flow Information					
Cash Flow from Operating Activities					
This information should be extracted from the Annual Financial Statements/ Balance sheets, which should be enclosed. Year 1 will be the latest year for which audited financial statements are available. Year 2 shall be the year immediately preceding year 1 and year 3 shall be the year immediately preceding Year 2.					

2. Sources of Finance

Specify sources of finance to meet the cash flow requirements on works currently in progress and for future contract commitments.

No.	Source of finance	Amount (Rs.)
1		
2		
3		

3. Financial documents

The Bidder and its parties shall provide copies of financial statements for _____ years pursuant Section III, Evaluation and Qualifications Criteria, Sub-factor 3.2. The financial statements shall:

- (a) reflect the financial situation of the Bidder or in case of JV member, and not an affiliated entity (such as parent company or group member).
- (b) be independently audited or certified in accordance with local legislation. In case of Indian bidders, the financial statements shall be audited by a certified chartered accountant.
- (c) be complete, including all notes to the financial statements.
- (d) correspond to accounting periods already completed and audited.

Attached are copies of financial statements¹ (balance sheets, including all related notes, and income statements) for the _____ years required above; and complying with the requirements

¹ If the most recent set of financial statements is for a period earlier than 12 months from the date of bid, the reason for this should be justified.

Appendix to Technical Part
(Mention the title in a separate annexure)

Form FIN - 3.2: Average Annual Construction Turnover

[To be completed by the Bidder and by each member of a Joint Venture]

Bidder's Legal Name: _____

Date: _____

Joint Venture Member's Legal Name _____

RFB No. and title: _____

Page _____ of _____ pages

Annual turnover data (construction only)	
Year	Amount in Rs.
<i>[indicate year]</i>	<i>[insert amount]</i>
Average Annual Construction Turnover *	

- * See Section III, Evaluation and Qualification Criteria, Sub-Factor 3.2. Annual construction turnover calculated as total certified payments received for work in progress or completed, for 5 years. This should be certified by a Chartered Accountant.

**Appendix to Technical Part
(Mention the title in a separate annexure)**

Not Applicable

JOINT VENTURE

Names of all members of a joint venture
1. Member in charge
2. Member
3. Member

Total value of annual construction turnover, in terms of work billed to clients, in Rupees

Annual Turnover Data (construction only; in Rs. *)							
Member	Form 3.2 page no.	Year 1	Year 2	Year 3	Year 4	Year 5	Average
1. Member in charge							
2. Member							
3. Member							
TOTALS							

*** To be certified by a chartered accountant**

Name and address of Bankers to the Joint Venture

Provide details regarding financial responsibility and participation (percentage share in the total) of each firm in the Joint Venture. Attach a Memorandum of Understanding for the Proposed Agreement of joint Venture which should lay down responsibility regarding work and financial arrangements in respect of each of the firm in the Joint Venture (Refer also ITB Clause 4.1).

Appendix to Technical Part

Form FIN - 3.3: Financial Resources

(Mention the title in a separate annexure)

Specify proposed sources of financing, such as liquid assets, unencumbered real assets, lines of credit, and other financial means, net of current commitments, available to meet the total construction cash flow demands of the subject contract or contracts as specified in Section III, Evaluation and Qualification Criteria.

Source of financing	Amount (Rs.)
1.	
2.	
3.	
4.	

FORMAT FOR EVIDENCE OF ACCESS TO OR AVAILABILITY OF CASH FLOW

[To be given from a Nationalized or Scheduled Bank in India]

Clause 3.1(ii) of Section III – Qualification Criteria

(1) AVAILABILITY OF CASH FLOW (WORKING CAPITAL)

This is to certify that M/s. _____ is a reputed company with a good financial standing.

If the contract for the works, namely _____ [funded by the World Bank] is awarded to the above firm, we shall be able to provide overdraft/credit facilities to the extent of Rs. equivalent _____ to meet their capital requirements for executing the above contract.

-- Sd. --

Name of Bank Manager

Senior Bank Manager
Address of the Bank

*** Change the text as follows for Joint venture:**

This is to certify that M/s. who has formed a JV with M/s. and M/s. for participating in this bid, is a reputed company with a good financial standing.

If the contract for the work, namely [funded by the World Bank] is awarded to the above Joint Venture, we shall be able to provide overdraft/credit facilities to the extent of Rs. to meet the working capital requirements for executing the above contract.

[This should be given by the JV members in proportion to their financial participation.]

Appendix to Technical Part
(Mention the title in a separate annexure)

Form EXP - 4.1: General Construction Experience

[The following table shall be filled in for the Bidder and for each member of a Joint Venture]

Bidder's Legal Name: _____
 Date: _____
 Joint Venture Member's Legal Name _____
 RFB No. and title: _____
 Page _____ of _____ pages

[Identify contracts that demonstrate continuous construction work over the past [5] years pursuant to Section III, Qualification Criteria and Requirements, Sub-Factor 4.1. List contracts chronologically, according to their commencement (starting) dates.]

Starting Month/ Year	Ending Month/ Year	Contract Identification	Role of Bidder [“Contractor” or “JV Member” or “Subcontractor” or “Contract
		Contract name: _____ Brief Description of the Works performed by the Bidder: _____ Amount of contract: _____ Name of Employer: _____ Address: _____	
		Contract name: _____ Brief Description of the Works performed by the Bidder: _____ Amount of contract: _____ Name of Employer: _____ Address: _____	
		Contract name: _____ Brief Description of the Works performed by the Bidder: _____ Amount of contract: _____ Name of Employer: _____ Address: _____	

Appendix to Technical Part
(Mention the title in a separate annexure)

**Form EXP - 4.2(a): Specific Construction and Contract
Management Experience**

[The following table shall be filled in for contracts performed by the Bidder, each member of a Joint Venture, and specialist sub-contractors]

Bidder's Legal Name: _____

Date: _____

Joint Venture Member's Legal Name _____

RFB No. and title: _____

Page _____ of _____ pages

Work performed as prime Contractor or JV Member or Sub-Contractor or Management Contractor (in the same name and style) on construction works of a similar nature and volume over the last five years². *[Attach certificate from the Engineer-in-charge.]*

Similar Contract No.	Information			
Contract Identification				
Award date				
Completion date				
Role in Contract	Prime Contractor <input type="checkbox"/>	Member in JV <input type="checkbox"/>	Management Contractor <input type="checkbox"/>	Sub- contractor <input type="checkbox"/>
Total Contract Amount	Rs. *			
If member in a JV or subcontractor, specify participation in total Contract amount			*	
Employer's Name:				
Address:				
Telephone/fax number				

²Immediately preceding the financial year in which bids are received.

E-mail:	
---------	--

**Appendix to Technical Part
(Mention the title in a separate annexure)**

**Form EXP - 4.2(a) (cont.)
Specific Construction and Contract Management Experience
(cont.)**

Similar Contract No.	Information
Description of the similarity in accordance with Sub-Factor 4.2(a) of Section III:	
1. Amount	
2. Physical size of required works items	
3. Complexity	
4. Methods/Technology	
5. Construction rate for key activities	
6. Other Characteristics	

Appendix to Technical Part
(Mention the title in a separate annexure)

Form EXP - 4.2(b): Construction Experience in Key Activities

Bidder's Legal Name: _____

Date: _____

Joint Venture Member's Legal Name _____

Subcontractor's Legal Name³ (as per ITB 33.2 and 33.3): _____

RFB No. and title: _____

Page _____ of _____ pages

Subcontractor's Name (as per ITB 33.2 and 33.3): _____

All subcontractors for key activities must complete the information in this form as per ITB 33.2 and 33.3 and Section III, Qualification Criteria and Requirements, Sub-Factor 4.2.

1. Key Activity No One: _____

	Information			
Contract Identification				
Award date				
Completion date				
Role in Contract	Prime Contractor <input type="checkbox"/>	Member in JV <input type="checkbox"/>	Management Contractor <input type="checkbox"/>	Sub- contractor <input type="checkbox"/>
Total Contract Amount	Rs.			
Quantity (Volume, number or rate of production, as applicable) performed under the contract per year or part of the year in the last 5 years	Total quantity in the contract (i)	Percentage participation (ii)	Actual Quantity Performed (i) x (ii)	
Year 1				

³ If applicable.

Year 2			
Year 3			
Year 4			
Year 5			

	Information
Employer's Name ⁴ :	
Address:	
Telephone/fax number	
E-mail:	

2. Activity No. Two

3.

	Information
Description of the key activities in accordance with Sub-Factor 4.2(b) of Section III:	

⁴Attach certificate from the Engineer-in-charge

**Appendix to Technical Part
(Mention the title in a separate annexure)**

Form EXP - 4.2(c)

Specific Experience in Managing ES aspects

[The following table shall be filled in for contracts performed by the Bidder, and each member of a Joint Venture]

Bidder's Name: _____

Date: _____

Bidder's JV Member Name: _____

RFB No. and title: _____

Page _____ of _____ pages

1. Key Requirement no 1 in accordance with 4.2 (c): _____

Contract Identification				
Award date				
Completion date				
Role in Contract	Prime Contractor <input type="checkbox"/>	Member in JV <input type="checkbox"/>	Management Contractor <input type="checkbox"/>	Subcontractor <input type="checkbox"/>
Total Contract Amount			Rs.	
Details of relevant experience				

2. Key Requirement no 2 in accordance with 4.2 (c): _____

3. Key Requirement no 3 in accordance with 4.2 (c): _____

...

Appendix to Technical Part
(Mention the title in a separate annexure)

Form.....

(Name of the Project)

(Declaration regarding tax/duty exemption for materials/construction equipment bought for the work)

(Bidder's Name and Address)

To:
(Name of the Employer & address)

Dear Sir:

Re: [Name of Work].....

Certificate for Import/Procurement of Goods/Construction Equipment

Government Order/Circular Number under which tax/duty Exemption is being sought: ...

1. We confirm that we are solely responsible for obtaining tax/duty waivers which we have considered in our bid and in case of failure to receive such waivers for reasons whatsoever, the employer will not compensate us.
2. We are furnishing below the information required by the Employer for issue of the necessary certificates in terms of the Government of India's relevant Notifications.
3. The goods/construction equipment for which certificates are required are as under:

Items (modify the list suitably for each specific work)*	Make/ Brand Name	Capacity [where applicable]	Quantity	Value	State whether it will be procured locally or imported [if so from which country]	Remarks regarding justification for the quantity and their usage in works.
Goods						
[a] Bitumen						
[b] Cement						
[c] Steel						
Construction Equipment						

--	--	--	--	--	--	--

4. We agree that no modification to the above list is permitted after bids are opened.
5. We agree that the certificate will be issued only to the extent considered reasonable by the Employer for the work, based on the Bill of Quantities and the construction program and methodology as furnished by us alongwith the bid.
6. We confirm that the above goods and construction equipment will be exclusively used for the construction of the above work and the construction equipment will not be sold or otherwise disposed of in any manner for a period of five years from the date of acquisition.

Date: _____

Place: _____

(Signature) _____

(Printed Name) _____

(Designation) _____

(Common Seal) _____

[This certificate will be issued within 60 days of signing of contract and no subsequent changes will be permitted.]

**** Modify the above to suit the requirements given in Government of India's Notifications as current of date of bidding.***

Appendix to Technical Part: Bid Security
(Mention the title in a separate annexure)

Form of Bid Security - Bank Guarantee

[Guarantor letterhead or SWIFT identifier code]

Bank Guarantee No.....[insert guarantee reference number]
 Date.....[insert date of issue of the guarantee]

WHEREAS, _____ [name of Bidder]⁵ (hereinafter called "the Applicant") has submitted his Bid dated _____ [date] or will submit his Bid for the construction of _____ [name of Contract] (hereinafter called "the Bid") under Request for Bids No.....[insert number] (hereinafter called "the RFB")

KNOW ALL PEOPLE by these presents that We _____ [name of bank] of _____ [name of country] having our registered office at _____ (hereinafter called "the Bank") are bound unto _____ [name of Employer] (hereinafter called "the Employer") in the sum of _____⁶ for which payment well and truly to be made to the said Employer the Bank binds itself, his successors and assigns by these presents.

SEALED with the Common Seal of the said Bank this _____ day of _____ 20____.

THE CONDITIONS of this obligation are:

- (1) If after Bid opening the Applicant (a) withdraws his bid during the period of Bid validity specified in the Letter of Bid, or any extended date provided by the Applicant ("the Bid Validity Period"); or (b) does not accept the correction of the Bid Price pursuant to ITB 36;

Or

⁵Insert name of the Bidder, which in the case of a joint venture shall be (a) the name of the joint venture that submits the bid if the JV has been constituted into a legally enforceable JV, or (b) the names of all future members of the JV as named in the letter of intent to execute the JV Agreement submitted by the bidder along with its bid.

⁶The Applicant should insert the amount of the guarantee in words and figures denominated in Indian Rupees. This figure should be the same as shown in Clause 19.1 of the Instructions to Bidders.

(2) If the Applicant having been notified of the acceptance of his bid by the Employer during the period of Bid validity:

- (a) fails or refuses to execute the Contract Agreement in accordance with the Instructions to Bidders, if required; or
- (b) fails or refuses to furnish the Performance Security and if required, the Environmental and Social (ES) Performance Security, in accordance with the Instruction to Bidders.

we undertake to pay to the Employer up to the above amount upon receipt of his first written demand, without the Employer having to substantiate his demand, provided that in his demand the Employer will note that the amount claimed by him is due to him owing to the occurrence of one or any of the four conditions, specifying the occurred condition or conditions.

This Guarantee will remain in force up to and including the date _____⁷ days after the deadline for submission of Bids as such deadline is stated in the Instructions to Bidders or as it may be extended by the Employer, notice of which extension(s) to the Bank is hereby waived. Any demand in respect of this guarantee should reach the Bank not later than the above date.

DATE _____ SIGNATURE OF THE BANK _____

WITNESS _____ SEAL _____

[signature, name, and address]

Note: All italicized text (including footnotes) is for use in preparing this form and shall be deleted from the final product.

⁷45 days after the end of the validity period of the Bid.

Appendix to Technical Part
(Mention the title in a separate annexure)

Form of Bid-Securing Declaration

Date: *[insert date (as day, month and year)]*
 RFB No.: *[insert number of Bidding process]*
 Alternative No.: *[insert identification No if this is a Bid for an alternative]*

To: *[insert complete name of Employer]*

We, the undersigned, declare that:

We understand that, according to your conditions, bids must be supported by a Bid-Securing Declaration.

We accept that we will automatically be suspended from being eligible for bidding or submitting proposals in any contract with the Employer for the period of time of *[insert number of months or years]* starting on *[insert date]*, if we are in breach of our obligation(s) under the bid conditions, because we:

- (a) have not accepted the correction of the Bid Price pursuant to ITB 36; or
- (b) have withdrawn our Bid during the period of Bid validity specified in the Letter of Bid or any extended date provided by us; or
- (c) having been notified of the acceptance of our Bid by the Employer during the period of bid validity, (i) fail or refuse to execute the Contract, if required, or (ii) fail or refuse to furnish the Performance Security and, if required, the Environmental and Social (ES) Performance Security, in accordance with the ITB.

We understand this Bid-Securing Declaration shall expire if we are not the successful Bidder, upon the earlier of (i) our receipt of your notification to us of the name of the successful Bidder; or (ii) forty-five days after the expiration of our Bid.

Name of the Bidder* _____ *[insert complete name of person signing the Bid]*

Name of the person duly authorized to sign the Bid on behalf of the Bidder** *[insert complete name of person duly authorized to sign the Bid]*

Title of the person signing the Bid *[insert complete title of the person signing the Bid]*

Signature of the person named above _____ *[insert signature of person whose name and capacity are shown above]*

Date signed *_[insert date of signing]day of [insert month], [insert year]*

*: In the case of the Bid submitted by joint venture specify the name of the Joint Venture as Bidder

** : Person signing the Bid shall have the power of attorney given by the Bidder to be attached with the Bid *[Note: In case of a Joint Venture, the Bid-Securing Declaration must be in the name of all members to the Joint Venture that submits the Bid.]*

Financial Appendix

Not to be submitted along with Technical Proposal.

Letter of Bid - Financial Part

(to be submitted on bidders letter head and dully signed to be sumitted by sucessful bidder after issue of LoI)

INSTRUCTIONS TO BIDDERS: DELETE THIS BOX ONCE YOU HAVE COMPLETED THE DOCUMENT

The Bidder must prepare this Letter of Bid on stationery with its letterhead clearly showing the Bidder's complete name and business address.

Note: All italicized text is to help Bidders in preparing this form.

Date of this Bid submission: *[insert date (as day, month and year) of Bid submission]*

Request for Bid No.: *[insert identification]*

To: *[insert complete name of Employer]*

We, the undersigned, hereby submit the second part of our Bid, the Bid Price and Bill of Quantities. This accompanies the Letter of Bid - Technical Part.

In submitting our Bid, we make the following additional declarations:

- a) **Bid Validity Period:** Our Bid shall be valid for a period specified in BDS 18.1 (or as amended if applicable) from the date fixed for the Bid submission deadline specified in BDS 22.1 (or as amended if applicable), and it shall remain binding upon us and may be accepted at any time before the expiration of that period;
- b) **Bid Price:** The total price of our Bid, excluding any discounts offered in item (c) below is: *[Insert one of the options below as appropriate]*

[Option 1, in case of one lot:] Total price is: [insert the total price of the Bid in Rs. in words and figures];

Or

[Option 2, in case of multiple lots:] (a) Total price of each lot [insert the total price of each lot in Rs. in words and figures]; and (b) Total price of all lots (sum of all lots) [insert the total price of all lots in Rs. words and figures];

- c) **Discounts:** The discounts offered and the methodology for their application are:

(i) The discounts offered are: *[Specify in detail each discount offered]*

- (ii) The exact method of calculations to determine the net price after application of discounts is shown below: *[Specify in detail the method that shall be used to apply the discounts]*;
- d) **Commissions, gratuities and fees:** We have paid, or will pay the following commissions, gratuities, or fees with respect to the Bidding process or execution of the Contract: *[insert complete name of each Recipient, its full address, the reason for which each commission or gratuity was paid and the amount and currency of each such commission or gratuity]*.

Name of Recipient	Address	Reason	Amount

(If none has been paid or is to be paid, indicate “none.”)

Name of the Bidder: **[insert complete name of person signing the Bid]*

Name of the person duly authorized to sign the Bid on behalf of the Bidder: *** [insert complete name of person duly authorized to sign the Bid]*

Title of the person signing the Bid: *[insert complete title of the person signing the Bid]*

Signature of the person named above: *[insert signature of person whose name and capacity are shown above]*

Date signed *[insert date of signing]* **day of** *[insert month]*, *[insert year]*

*: In the case of the Bid submitted by a Joint Venture specify the name of the Joint Venture as Bidder.

** : Person signing the Bid shall have the power of attorney given by the Bidder. The power of attorney shall be attached with the Bid Schedules

Please Note that the bidder has to enter their undertaking/declaration for the above mentioned under General/Special Conditions of Contracts in KPP portal. No Financial forms are allowed to be uploaded in KPPP. He

(To be submitted by the Successful bidder after issue of LoI)
Appendix to Financial Part: Schedules
Sub-contracting

SCHEDULE OF SUBCONTRACTORS

[Note: Entries in this Schedule shall be the same as included in the same Schedule in the technical part of the bid, except for the column on 'Approximate value of subcontract' added in the table below]

Item	Element of work	Approximate value of subcontract	% of bid price	Name and address of sub-contractor	Qualification and experience of sub-contractor on similar works of the elements executed

The Bidder shall enter in this schedule a list of the major sections and appropriate value of the work for which he proposed to use subcontractors *[for those costing more than 10% of the bid price for each element]*, together with the names, addresses and experiences of the proposed subcontractors.

The capability of the subcontractor will also be assessed (on the same lines as for the main Contractor) before according approval to him.

(Work should not be split into small parts and subcontracted; but subcontracting specialized elements of works is acceptable).

Appendix to Financial Part: Schedules

Bill of Quantities

Enclosed

ITEM CODE	DESCRIPTION	UNIT	QUANTITY	RATE EXCLUDING GST COST (IN INR)
code01	<p>MRF Shed: Earth work excavation for Foundation by mechanical means for all works & depth upto 3 m, as per drawing and technical specifications, including setting out, shoring, strutting, barricading, caution lights, including dressing of excavated surfaces, disposing off or levelling the excavated earth or sorting & stacking the selected earth for reuse in a radius of 50 m and lift upto 1.5m including cost of labour, tools, usage of machinery & other appurtenances required to complete the work. In ordinary/soft rock without blasting upto 1.5 m depth (Item No. 1.15.1 Page No. 8 Vol.1 Common SR)</p>	Cum	48.41	
code02	<p>Providing and laying in position plain cement concrete for levelling course for all works in foundation. The granite/trap/basalt crushed graded coarse aggregates and fine aggregates as per relevant IS Codes machine mixed, laid in layers not exceeding 150 mm thickness, well compacted using plate vibrators, including all lead & lifts, cost of all materials of quality, labour, Usage charges of machineries, curing, and all the other appurtenances required to complete the work as per technical specifications. Mix 1:3:6 Using 40 mm nominal size graded crushed coarse aggregates (Item No. 2.1.3 Page No. 15 Vol.1 Common SR)</p>	Cum	74.66	
code03	<p>Providing and laying in position Cement Concrete for all Foundation works. The granite/trap/basalt crushed graded coarse aggregates and fine aggregates as per relevant IS Codes machine mixed with super plasticizers laid in finished layers, well compacted using needle vibrators, including all lead & lifts, cost of all materials, quality confirming to the requirements of relevant IS codes, labour, Usage charges of machinery, curing and all the other appurtenances required to complete the work as per technical specifications. M25 Design Mix Using 20 mm nominal size graded crushed coarse aggregates (Item No. 2.2.3 Page No. 15 Vol.1 Common SR & Appendix I page No.111) (footing)</p>	Cum	17.68	

ITEM CODE	DESCRIPTION	UNIT	QUANTITY	RATE EXCLUDING GST COST (IN INR)
code04	Providing and laying in position Cement Concrete for all Foundation works. The granite/trap/basalt crushed graded coarse aggregates and fine aggregates as per relevant IS Codes machine mixed with super plasticizers laid in finished layers, well compacted using needle vibrators, including all lead & lifts, cost of all materials, quality confirming to the requirements of relevant IS codes, labour, Usage charges of machinery, curing and all the other appurtenances required to complete the work as per technical specifications. M25 Design Mix Using 20 mm nominal size graded crushed coarse aggregates (Item No. 2.2.3 Page No. 15 Vol.1 Common SR & Appendix I page No.111)(coulmn base)	Cum	7.31	
code05	Providing and laying in position Cement Concrete for all Sub structures of building, Irrigation works, Sub structure works of bridges, Drain works & other parallel works from 0.50m to 3.50 m height. The granite/trap/basalt crushed graded coarse aggregates and fine aggregates as per relevant IS Codes machine mixed with super plasticisers, laid in layers, well compacted using needle vibrators, providing weep holes wherever necessary, including all lead & lifts, cost of all materials of quality, confirming to the requirements of relevant IS codes, labour, Usage charges of machinery, curing and all other appurtenances required to complete the work as per technical specifications M25 Design Mix Using 20 mm nominal size graded crushed coarse aggregates (Item No. 2.4.3Page No. 16 Vol.1 CSR 2023-24)	Cum	6.65	
code06	Supplying, fitting and placing TMT FE 550 / 550D Steel Reinforcementincluding cost of all materials, machinery, labour, cleaning, straightening, cutting, bending, hooking, laping/welding joints, tying with binding wire / softannealed steel wire and other ancillary operations complete as per drawing andtechnical specification. Buildings (Item No. 2.11a Page No. 18 Vol.1 Common SR)	Tonne	9.226	

ITEM CODE	DESCRIPTION	UNIT	QUANTITY	RATE EXCLUDING GST COST (IN INR)
code07	Providing Size Stone masonry with hard stone in foundation & plinth with Cement mortar 1:6 (1 cement : 6 coarse sand) (CSR 2023-24, Volume- II It No 5.4 Page No 9)	Cum	37.53	
code08	Filling available excavated earth (excluding rock) in trenches, plinth, sides of foundations and other similar works etc. in layers not exceeding 20cm in depth, consolidating each deposited layer by ramming and watering, lead up to 50 m and lift upto 1.5 m. (PWD CSR 2023-24, Volume-I It No 1.9 Page No7)	Cum	378.65	
code09	Providing and Filling in foundation with granite / trap broken metal 100mm. and down size, with approved sand including hand packing, ramming, watering, including cost of all materials and labour with all lead and lift. complete as per specifications. (PWD CSR 2023-24, Volume-I Item no 1.23 page no 11)	Cum	13.34	
code10	Providing and constructing load bearing wall with Solid Concrete blocks of size 400x150x200mm having block density more than 1800kg/m ³ and minimum compressive strength of 4.00 N/mm ² conforming to IS 2185 (Part - I) - 2005 and constructed with CM 1:4 as per IS 2572:2005 including cost of all materials, labour, scaffolding and curing, usage charges of machinery etc complete as per specifications. (Item No. 6.33 Page No. 17 Vol.2 PWD SR)	cum	133.2	
code11	Providing 20 mm cement plaster of mix :1:4 (1 cement: 4 fine sand) to brick/stone masonry including rounding off corners wherever required smooth rendering, providing and removing scaffolding, including cost of materials, labour, curing complete as per specifications and as per directions of Engineer-in-charge.(Item No. 8.3.1, Page No. 41, Vol.2)	Sqm	268	

ITEM CODE	DESCRIPTION	UNIT	QUANTITY	RATE EXCLUDING GST COST (IN INR)
code12	Providing and fixing Steel work in built up tubular (round, square or rectangular hollow tubes etc.) trusses etc., including cutting, hoisting, fixing in position and applying a priming coat of approved steel primer, including welding and bolted with special shaped washers etc. complete. Hot finished seamless type tubes including cost of materials, labour, usage charges of machinery complete as per specifications and as per directions of the Engineer-in-Charge. Volume 2 (PWD CSR 2023-24 It.No 11.16.1 Page 82.)	Kg	16405	
code13	Providing & fixing corrugated G.S. sheet roofing including vertical / curved surface fixed with polymer coated J or L hooks, bolts and nuts 8 mm diameter with bitumen and G.I. limpet washers or with G.I. limpet washers filled with white lead, including a coat of approved steel primer and two coats of approved paint on overlapping of sheets complete as per design drawings (up to any pitch in horizontal/ vertical or curved surfaces), excluding the cost of purlins, rafters and trusses and including cutting to size and shape wherever required as per the direction of Engineer in charge. 0.63 mm thick with zinc coating not less than 275 g/ m ² Volume II(PWD CSR 2023-24 It.No.7.1.1 ,P.No.21)	Sqm	1072.99	
code14	Providing & fixing ridges or hips of width 60 cm overall width plain G.S. sheet fixed with polymer coated J or L hooks, bolts and nuts 8 mm dia G.I. limpet and bitumen washers complete as per design drawings. 0.63 mm thick with zinc coating not less than 275 g/m ² (Item No. 7.4.1, Page No. 21, Vol.2)	m	27.45	
code15	Providing and applying white cement based putty of average thickness 1 mm, of approved brand and manufacturer, over the plastered wall surface to prepare the surface even and smooth complete as per specifications and as per directions of Engineer in charge. (Item No. 8.51, Page No. 50, Vol.2)	Sqm	268	

ITEM CODE	DESCRIPTION	UNIT	QUANTITY	RATE EXCLUDING GST COST (IN INR)
code16	Wall painting with premium acrylic emulsion paint of interior grade, having VOC (Volatile Organic Compound) content less than 50 g/L of approved brand and manufacture, including applying additional coats wherever required to achieve even shade and colour. One coat as per specifications and as per directions of Engineer in charge.(Item No. 8.54.1, Page No. 50, Vol.2)	Sqm	268	
code17	Supplying and fixing rolling shutters of approved make, made of required size M.S. laths, interlocked together through their entire length and jointed together at the end by end locks, mounted on specially designed pipe shaft with brackets, side guides and arrangements for inside and outside locking with push and pull operation complete, including the cost of providing and fixing necessary 27.5 cm long wire springs manufactured from high tensile steel wire of adequate strength conforming to IS: 4454 - part 1 and M.S. top cover of required thickness for rolling shutters. 80x1.25 mm M.S. laths with 1.25 mm thick top cover including cost of materials, labour, usage charges of machinery complete as per specifications and as per directions of the Engineer-in-Charge. (Item No. 11.6.1, Page No. 78, Vol.2)	sqm	40	
code18	Extra for providing 2 HP Mild Steel Auto Reverse Shutter Gearbox for operating rolling shutters including cost of materials, labour, usage charges of machinery complete as per specifications and as per directions of the Engineer-in-Charge.(Item No. 11.8.4, Page No. 79, Vol.2)	each	2	

ITEM CODE	DESCRIPTION	UNIT	QUANTITY	RATE EXCLUDING GST COST (IN INR)
code19	:Providing and fixing aluminium work for doors, windows, ventilators and partitions with extruded built up standard tubular sections/ appropriate sections and other sections of approved make conforming to IS: 733 and IS:1285, fixing with dash fasteners of required dia and size, including necessary filling up the gaps at junctions, i.e. at top, bottom and sides with required EPDM rubber/ neoprene gasket etc. Aluminium sections shall be smooth, rust free, straight, mitred and jointed mechanically wherever required including cleat angle, Aluminium snap beading for glazing / paneling, C.P. brass / stainless steel screws, all complete as per architectural drawings and the directions of Engineer-in-charge. (Glazing, paneling and dash fasteners to be paid for separately) :For Fixed Portion: Powder coated aluminium (minimum thickness of powder coating 50 micron) including cost of materials, labour, usage charges of machinery complete as per specifications..(Item No. 11.35.1.1, Page No. 87, Vol.2)	kg	300	
code20	Providing and fixing 1mm thick M.S. sheet door with frame of 40x40x6mm angle iron and 3 mm M.S. gusset plates at the junctions and corners, all necessary fittings complete, including applying a priming coat of approved steel primer. Using M.S. angles 40x40x6 mm for diagonal braces including cost of materials, labour, usage charges of machinery complete as per specifications and as per directions of the Engineer-in-Charge. (Item No. 11.5.1, Page No. 77, Vol.2)	sqm	10.08	
code21	Providing Honne wood frames of doors, windows, clerestory windows, ventilators and other frames, wrought, framed or assembled including making plaster groves (excluding cost of cement concrete and side clamps), but including cost of materials, labour, usage charges complete as per specifications.(PWD CSR 2023-24 VOLUME 2, Item No 12.11 page -99) (door)	Cum	0.28	

ITEM CODE	DESCRIPTION	UNIT	QUANTITY	RATE EXCLUDING GST COST (IN INR)
code22	Providing & fixing of 2-track x 2-panel sliding windows made out of multi chambered UPVC(Matching to RAL-9016) sections and with minimum TiO2(Titanium Dioxide) at 6PHR with TPE(Thermo Plastic Elastomer) and lead free, gaskets -grey colour having isolated drainage and reinforced with Galvanized Iron profile through-out the window frame. The outer frame having a overall size of 60mm width x 45mmheight with reinforcement of 1mm thickness and Sash with overall size of 39mm X 58mm with GI reinforcement of 1mm for the frame and 1.5 mm for the sash. Coextruded Glazing bead for fixing of glass shall be of size 20mm x 24mm. Windows shall be provided with 5mm plain float glass, standard hardware& single point locking system with touch lock. Wall thickness of frame & sash shall be of 2-2.5 mm. Maximum possible size 1819mm x 1819mm (The cost is inclusive of all fixtures and separate charges for minor T&P's shall not be made)(PWD CSR 2023-24 VOLUME 2,Item No 12.88 page - 110)	Sqm	9	
code23	Providing and fixing M.S. grills of required pattern in frames of windows etc. with M.S. flats, square or round bars etc. including priming coat with approved steel primer all complete. Fixed to steel windows by welding.(Item No. 11.34A, Page No. 86, Vol.2)	kg	78	
code24	Providing & fixing of louvered ventilator made out of multi chambered UPVC(Matching to RAL-9016) sections and with minimum TiO2(Titanium Dioxide) at 6PHR with TPE(Thermo Plastic Elastomer) and lead free with gaskets -grey colour having isolated drainage and reinforced with Galvanized Iron profile through out the ventilator frame. The frame having overall size of 39mm x 39mm with GI reinforcement of 1mm thickness. Louver clip in Aluminium (powder coated in white will be used on the frame along with plastic parts for fixing the 4 mm pin head glass.Wall thickness of frame shall be 2mm.Maximum possible size -1000mm x 1000mm.(The cost is inclusive of all fixtures and separate charges for minor T&Ps shall not be made)(PWD CSR 2023-24 VOLUME 2,Item No 12.85 page -109)	Sqm	2.88	

ITEM CODE	DESCRIPTION	UNIT	QUANTITY	RATE EXCLUDING GST COST (IN INR)
code25	Providing and laying 5mm thick Self levelling Epoxy Flooring for Residential, Commercial, Sports& Industrial purpose made of reputed brand applied at 1L/m2 on existing Concrete substrate of 25Mpa or more. The Concrete shall be free from any defects and cracks. The epoxy compound shall have low VOC (Based on USEPA Method 24 Section 11.2.2 & ASTM D2369-98) and is chemically resistant & antimicrobial. The surface of Concrete shall be cleaned thoroughly and free from laitance and applied with primer cured for 6-8 hours. The mix shall be mixed using Hand mixing rotary machine. The underlay shall be laid with 3mm thickness and overlay at 2mm. The entire operation shall be finished in line with epoxy coving and marked with 100mm thickness yellow marking lines complete as per the direction of Engineer in charge.(Item No. 9.41, Page No. 65, Vol.2)	Sqm	411.75	
code26	Providing and fixing Aluminium Turbo ventilator complete as per technical specifications Non Power Driven with 1.3mm thickness and 38 No.s of Vanes & turbine doom thickness 1mm and total weight not less than 6kg for Industrial use for area upto 100m2 for Industrial use (PWD CSR 2023-24 VOLUME 2,Item No 7.69.3 page -38)	Each	20	
code27	Toilet, Security Room, Weigh Bridge office : Earth work excavation for Foundation by mechanical means for all works &depth upto 3 m, as per drawing and technical specifications, including settingout, shoring, strutting, barricading, caution lights, including dressing ofexcavated surfaces, disposing off or levelling the excavated earth or sorting& stacking the selected earth for reuse in a radius of 50 m and lift upto 1.5m including cost of labour, tools, usage of machinery & other appurtenacesrequired to complete the work. In ordinary/soft rock without blasting upto 1.5 m depth (Item No. 1.15.1 Page No. 8 Vol.1 Common SR)	Cum	40.07	

ITEM CODE	DESCRIPTION	UNIT	QUANTITY	RATE EXCLUDING GST COST (IN INR)
code28	Providing and laying in position plain cement concrete for levelling course for all works in foundation. The granite/trap/basalt crushed graded coarse aggregates and fine aggregates as per relevant IS Codes machine mixed, laid in layers not exceeding 150 mm thickness, well compacted using plate vibrators, including all lead & lifts, cost of all materials of quality, labour, Usage charges of machineries, curing, and all the other appurtenances required to complete the work as per technical specifications. Mix 1:3:6 Using 40 mm nominal size graded crushed coarse aggregates (Item No. 2.1.3 Page No. 15 Vol.1 Common SR)	Cum	11.42	
code29	Providing and laying in position Cement Concrete for all Foundation works.The granite/trap/basalt crushed graded coarse aggregates and fine aggregates as per relevant IS Codes machine mixed with super plasticizers laid in finished layers, well compacted using needle vibrators, including all lead & lifts, cost of all materials, quality confirming to the requirements of relevant IS codes, labour, Usage charges of machinery, curing and all the other appurtenances required to complete the work as per technical specifications. (M20 Design Mix Using 20 mm nominal size graded crushed coarse aggregates (Item No. 2.2.1 Page No. 15 Vol.1 Common SR & Appendix I page No.111)	Cum	12.62	
code30	Supplying, fitting and placing TMT FE 550 / 550D Steel Reinforcement including cost of all materials, machinery, labour, cleaning, straightening, cutting, bending, hooking, laping/welding joints, tying with binding wire / soft annealed steel wire and other ancillary operations complete as per drawing and technical specification. Buildings (Item No. 2.11a Page No. 18 Vol.1 Common SR)	Tonne	1.351	
code31	Providing Size Stone masonry with hard stone in foundation & plinth with Cement mortar 1:6 (1 cement : 6 coarse sand) (CSR 2023-24, Volume- II It No 5.4 Page No 9)	Cum	22.92	

ITEM CODE	DESCRIPTION	UNIT	QUANTITY	RATE EXCLUDING GST COST (IN INR)
code32	Filling available excavated earth (excluding rock) in trenches, plinth, sides of foundations and other similar works etc. in layers not exceeding 20cm in depth, consolidating each deposited layer by ramming and watering, lead up to 50 m and lift upto 1.5 m. (PWD CSR 2023-24, Volume-I It No 1.9 Page No 7)	Cum	20.17	
code33	Providing and Filling in foundation with granite / trap broken metal 100mm. anddown size & with approved sand including hand packing, ramming, watering,including cost of all materials and labour with all lead and lift complete as perspecifications. (CSR 2023-24, Volume-I It No 1.23 Page No 11)	Cum	7.97	
code34	Providing and constructing laterite size stone masonry including cost and conveyance of all materials curing etc complete as per specification. I.S. 3620/1979 having compressive strength not less then 3.5 N/mm2 for saturated dry samples. For Superstructure in CM 1:6 1st Corrigendum and Addendum order - 21-04-2022(PWD CSR 2023-24, Volume-II It No 5.7 Page No 9)	Cum	31.63	
code35	Providing 20 mm cement plaster of mix :1:4 (1 cement: 4 fine sand) to brick/stone masonry including rounding off corners wherever required smooth rendering, providing and removing scaffolding, including cost of materials, labour, curing complete as per specifications and as per directions of Engineer-in-charge.(Item No. 8.3.1, Page No. 41, Vol.2)	Sqm	173.72	
code36	Providing White washing with lime to give an even shade :New work(three coats) with lime of approved quality, including cost of materials, labour complete as per specifications and as per directions of Engineer in-charge.(Item No. 8.21, Page No. 44, Vol.2)	Sqm	173.72	

ITEM CODE	DESCRIPTION	UNIT	QUANTITY	RATE EXCLUDING GST COST (IN INR)
code37	Finishing walls with water proofing cement paint of required shade :New work (Two coats applied @ 4.84 kg/10 m2) to give an even shade after thoroughly brooming the surface to remove all dirt, dust, mortar drops and foreign matter including preparing the surface even and sand paper smooth, cost of materials, labour complete as per specifications and as per directions of Engineer-in-charges.(Item No. 8.28, Page No. 45, Vol.2)	Sqm	173.72	
code38	Providing and laying Cement concrete flooring 40 mm thick with 20 mm nominal size stone aggregate using 1:2:4 (1 cement : 2 coarse sand : 4 graded stone aggregate) finished with a floating coat of neat cement, including cement slurry complete(Item No. 9.1 Page No.59 Vol.2 CSR 2023-24)	Sqm	42.28	
code39	Providing and laying vitrified floor tiles with thickness 9-10 mm in different sizes with water absorption less than 0.08% and conforming to IS: 15622, of approved make, in all colours and shades, laid on 20mm thick cement mortar 1:4 (1 cement : 4 coarse sand), jointing with grey cement slurry @ 3.3 kg/ m2 including grouting the joints with white cement and matching pigments etc., complete Size of Tile 600x600 mm (Item No. 9.12.2 Page No. 60 Vol.2 PWD SR)	Sqm	50.74	
code40	Providing and laying vitrified floor tiles with thickness 9-10 mm in different sizes with water absorption less than 0.08% and conforming to IS: 15622, of approved make, in all colours and shades, laid on 20mm thick cement mortar 1:4 (1 cement : 4 coarse sand), jointing with grey cement slurry @ 3.3 kg/ m2 including grouting the joints with white cement and matching pigments etc., complete Size of Tile 600x600 mm (Item No. 9.12.2 Page No. 60 Vol.2 PWD SR) skirting	Sqm	38.23	

ITEM CODE	DESCRIPTION	UNIT	QUANTITY	RATE EXCLUDING GST COST (IN INR)
code41	Providing & fixing White vitreous china water closet squatting pan (Indian type) along with S or P trap including dismantling of old WC seat and S or P trap at site complete with all operations including all necessary materials, labour and disposal of dismantled material including malba, all complete as per the direction of Engineer-in charge. Orissa pattern W.C Pan of size 580x440 mm (Item No. 20.44 Page No. 202 Vol.2 PWD SR)	each	3	
code42	Providing and fixing white vitreous china pedestal type water closet (European type W.C. pan) with seat and lid, 10 litre low level white P.V.C. flushing cistern, including flush pipe, with manually controlled device (handle lever), conforming to IS: 7231, with all fittings and fixtures complete, including cutting and making good the walls and floors wherever required: W.C. pan with ISI marked white solid plastic seat and lid (Item No. 14.2.1 Page No. 131 Vol.2 PWD SR)	each	2	
code43	Providing and fixing wash basin with C.I. brackets, 15 mm C.P. brass pillar taps, 32 mm C.P. brass waste of standard pattern, including painting of fittings and brackets, cutting and making good the walls wherever require: White Vitreous China Wash basin size 630x450 mm with a single 15 mm C.P. brass pillar tap (Item No. 14.7.1 Page No. 132 Vol.2 PWD SR)	each	3	
code44	Providing and fixing white vitreous china flat back or wall corner type lipped front urinal basin of 430x260x350 mm or 340x410x265 mm sizes respectively.(Item No. 14.23 Page No. 135 Vol.2 PWD SR)	each	6	
code45	Providing and placing on terrace (at all floor levels) polyethylene water storage tank, IS: 12701 marked, with cover and suitable locking arrangement and making necessary holes for inlet, outlet and overflow pipes but without fittings and the base support for tank.(Item No. 13.34 Page No. 123 Vol.2 PWD SR)	L	6000	

ITEM CODE	DESCRIPTION	UNIT	QUANTITY	RATE EXCLUDING GST COST (IN INR)
code46	Providing and fixing 1mm thick M.S. sheet door with frame of 40x40x6mm angle iron and 3 mm M.S. gusset plates at the junctions and corners, all necessary fittings complete, including applying a priming coat of approved steel primer. Using M.S. angles 40x40x6 mm for diagonal braces including cost of materials, labour, usage charges of machinery complete as per specifications and as per directions of the Engineer-in-Charge. (Item No. 11.5.1, Page No. 77, Vol.2)	Sqm	8.4	
code47	Providing Honne wood frames of doors, windows, clerestory windows, ventilators and other frames, wrought, framed or assembled including making plaster groves (excluding cost of cement concrete and side clamps), but including cost of materials, labour, usage charges complete as per specifications. (PWD CSR 2023-24 VOLUME 2, Item No 12.11 page -99)	Cum	0.28	
code48	Providing & fixing of 2-track x 2-panel sliding windows made out of multi chambered UPVC (Matching to RAL-9016) sections and with minimum TiO ₂ (Titanium Dioxide) at 6PHR with TPE (Thermo Plastic Elastomer) and lead free, gaskets -grey colour having isolated drainage and reinforced with Galvanized Iron profile through-out the window frame. The outer frame having a overall size of 60mm width x 45mm height with reinforcement of 1mm thickness and Sash with overall size of 39mm X 58mm with GI reinforcement of 1mm for the frame and 1.5 mm for the sash. Coextruded Glazing bead for fixing of glass shall be of size 20mm x 24mm. Windows shall be provided with 5mm plain float glass, standard hardware & single point locking system with touch lock. Wall thickness of frame & sash shall be of 2-2.5 mm. Maximum possible size 1819mm x 1819mm (The cost is inclusive of all fixtures and separate charges for minor T&P's shall not be made) (PWD CSR 2023-24 VOLUME 2, Item No 12.88 page - 110)	sqm	9	

ITEM CODE	DESCRIPTION	UNIT	QUANTITY	RATE EXCLUDING GST COST (IN INR)
code49	Providing and fixing M.S. grills of required pattern in frames of windows etc. with M.S. flats, square or round bars etc. including priming coat with approved steel primer all complete. Fixed to steel windows by welding.(Item No. 11.34A, Page No. 86, Vol.2)	Kg	97.5	
code50	Providing & fixing of louvered ventilator made out of multi chambered UPVC(Matching to RAL-9016) sections and with minimum TiO2(Titanium Dioxide) at 6PHR with TPE(Thermo Plastic Elastomer) and lead free with gaskets -grey colour having isolated drainage and reinforced with Galvanized Iron profile through out the ventilator frame. The frame having overall size of 39mm x 39mm with GI reinforcement of 1mm thickness. Louver clip in Aluminium (powder coated in white will be used on the frame along with plastic parts for fixing the 4 mm pin head glass.Wall thickness of frame shall be 2mm.Maximum possible size -1000mm x 1000mm.(The cost is inclusive of all fixtures and separate charges for minor T&Ps shall not be made)(PWD CSR 2023-24 VOLUME 2,Item No 12.85 page -109)	sqm	2.16	
code51	Fire extinguisher room: Earth work excavation for Foundation by mechanical means for all works &depth upto 3 m, as per drawing and technical specifications, including settingout, shoring, strutting, barricading, caution lights, including dressing ofexcavated surfaces, disposing off or levelling the excavated earth or sorting& stacking the selected earth for reuse in a radius of 50 m and lift upto 1.5m including cost of labour, tools, usage of machinery & other appurtenacesrequired to complete the work. In ordinary/soft rock without blasting upto 1.5 m depth (Item No. 1.15.1 Page No. 8 Vol.1 Common SR)	Cum	10.15	

ITEM CODE	DESCRIPTION	UNIT	QUANTITY	RATE EXCLUDING GST COST (IN INR)
code52	Providing and laying in position plain cement concrete for levelling course for all works in foundation. The granite/trap/basalt crushed graded coarse aggregates and fine aggregates as per relevant IS Codes machine mixed, laid in layers not exceeding 150 mm thickness, well compacted using plate vibrators, including all lead & lifts, cost of all materials of quality, labour, Usage charges of machineries, curing, and all the other appurtenances required to complete the work as per technical specifications. Mix 1:3:6 Using 40 mm nominal size graded crushed coarse aggregates (Item No. 2.1.3 Page No. 15 Vol.1 Common SR)	Cum	9.05	
code53	Providing and laying in position Cement Concrete for all Foundation works.The granite/trap/basalt crushed graded coarse aggregates and fine aggregates as per relevant IS Codes machine mixed with super plasticizers laid in finished layers, well compacted using needle vibrators, including all lead & lifts, cost of all materials, quality confirming to the requirements of relevant IS codes, labour, Usage charges of machinery, curing and all the other appurtenances required to complete the work as per technical specifications. (M20 Design Mix Using 20 mm nominal size graded crushed coarse aggregates (Item No. 2.2.1 Page No. 15 Vol.1 Common SR & Appendix I page No.111)	Cum	4.5	
code54	Supplying, fitting and placing TMT FE 550 / 550D Steel Reinforcement including cost of all materials, machinery, labour, cleaning, straightening, cutting, bending, hooking, laping/welding joints, tying with binding wire / soft annealed steel wire and other ancillary operations complete as per drawing and technical specification. Buildings (Item No. 2.11a Page No. 18 Vol.1 Common SR)	Tonne	0.427	
code55	Providing Size Stone masonry with hard stone in foundation & plinth with Cement mortar 1:6 (1 cement : 6 coarse sand) (CSR 2023-24, Volume- II It No 5.4 Page No 9)	Cum	14.22	

ITEM CODE	DESCRIPTION	UNIT	QUANTITY	RATE EXCLUDING GST COST (IN INR)
code56	Filling available excavated earth (excluding rock) in trenches, plinth, sides of foundations and other similar works etc. in layers not exceeding 20cm in depth, consolidating each deposited layer by ramming and watering, lead up to 50 m and lift upto 1.5 m. (PWD CSR 2023-24, Volume-I It No 1.9 Page No 7)	Cum	20.98	
code57	Providing and Filling in foundation with granite / trap broken metal 100mm. and down size & with approved sand including hand packing, ramming, watering, including cost of all materials and labour with all lead and lift complete as per specifications. (CSR 2023-24, Volume-I It No 1.23 Page No 11)	Cum	13.99	
code58	Providing and constructing laterite size stone masonry including cost and conveyance of all materials curing etc complete as per specification. I.S. 3620/1979 having compressive strength not less than 3.5 N/mm ² for saturated dry samples. For Superstructure in CM 1:6 1st Corrigendum and Addendum order - 21-04-2022(PWD CSR 2023-24, Volume-II It No 5.7 Page No 9)	Cum	12.63	
code59	Providing 20 mm cement plaster of mix :1:4 (1 cement: 4 fine sand) to brick/stone masonry including rounding off corners wherever required smooth rendering, providing and removing scaffolding, including cost of materials, labour, curing complete as per specifications and as per directions of Engineer-in-charge.(Item No. 8.3.1, Page No. 41, Vol.2)	Sqm	67.43	
code60	Providing White washing with lime to give an even shade :New work(three coats) with lime of approved quality, including cost of materials, labour complete as per specifications and as per directions of Engineer in-charge.(Item No. 8.21, Page No. 44, Vol.2)	Sqm	67.43	

ITEM CODE	DESCRIPTION	UNIT	QUANTITY	RATE EXCLUDING GST COST (IN INR)
code61	Finishing walls with water proofing cement paint of required shade :New work (Two coats applied @ 4.84 kg/10 m2) to give an even shade after thoroughly brooming the surface to remove all dirt, dust, mortar drops and foreign matter including preparing the surface even and sand paper smooth, cost of materials, labour complete as per specifications and as per directions of Engineer-in-charges.(Item No. 8.28, Page No. 45, Vol.2)	sqm	67.43	
code62	Providing and laying vitrified floor tiles with thickness 9-10 mm indifferent sizes with water absorption less than 0.08% and conforming toIS: 15622, of approved make, in all colours and shades, laid on 20mm thickcement mortar 1:4 (1 cement : 4 coarse sand), jointing with grey cementslurry @ 3.3 kg/ m2 including grouting the joints with white cement andmatching pigments etc., complete Size of Tile 600x600 mm (Item No. 9.12.2 Page No. 60 Vol.2 PWD SR)	Sqm	19.97	
code63	Providing and fixing 1mm thick M.S. sheet door with frame of 40x40x6mm angle iron and 3 mm M.S. gusset plates at the junctions andcorners, all necessary fittings complete, including applying a primingcoat of approved steel primer. Using M.S. angels 40x40x6 mm for diagonalbraces including cost of materials, labour, usage charges of machinerycomplete as per specifications and as per directions of the Engineer-in-Charge.(Item No. 11.5.1, Page No. 77, Vol.2)	Sqm	2.1	
code64	Providing Honne wood frames of doors, windows, clerestory windows, ventilators and other frames, wrought, framed or assembled including making plaster groves (excluding cost of cement concrete and side clamps), but including cost of materials, labour, usage charges complete as per specifications.(PWD CSR 2023-24 VOLUME 2,Item No 12.11 page -99)	Cum	0.07	

ITEM CODE	DESCRIPTION	UNIT	QUANTITY	RATE EXCLUDING GST COST (IN INR)
code65	<p>Providing & fixing of louvered ventilator made out of multi chambered UPVC(Matching to RAL-9016) sections and with minimum TiO2(Titanium Dioxide) at 6PHR with TPE(Thermo Plastic Elastomer) and lead free with gaskets -grey colour having isolated drainage and reinforced with Galvanized Iron profile through out the ventilator frame. The frame having overall size of 39mm x 39mm with GI reinforcement of 1mm thickness. Louver clip in Aluminium (powder coated in white will be used on the frame along with plastic parts for fixing the 4 mm pin head glass.Wall thickness of frame shall be 2mm.Maximum possible size 1000mm x 1000mm.(The cost is inclusive of all fixtures and separate charges for minor T&Ps shall not be made)(PWD CSR 2023-24 VOLUME 2,Item No 12.85 page -109)</p>	sqm	1.44	
code66	<p>Office Building: Earth work excavation for Foundation by mechanical means for all works &depth upto 3 m, as per drawing and technical specifications, including settingout, shoring, strutting, barricading, caution lights, including dressing ofexcavated surfaces, disposing off or levelling the excavated earth or sorting& stacking the selected earth for reuse in a radius of 50 m and lift upto 1.5m including cost of labour, tools, usage of machinery & other appurtenacesrequired to complete the work. In ordinary/soft rock without blasting upto 1.5 m depth (Item No. 1.15.1 Page No. 8 Vol.1 Common SR)</p>	Cum	34.49	
code67	<p>Providing and laying in position plain cement concrete for levelling course for all works in foundation. The granite/trap/basalt crushed graded coarse aggregates and fine aggregates as per relevant IS Codes machine mixed, laid in layers not exceeding 150 mm thickness, well compacted using plate vibrators, including all lead & lifts, cost of all materials of quality, labour, Usage charges of machineries, curing, and all the other appurtenances required to complete the work as per technical specifications. Mix 1:3:6 Using 40 mm nominal size graded crushed coarse aggregates (Item No. 2.1.3 Page No. 15 Vol.1 Common SR)</p>	Cum	10.19	

ITEM CODE	DESCRIPTION	UNIT	QUANTITY	RATE EXCLUDING GST COST (IN INR)
code68	Providing and laying in position Cement Concrete for all Foundation works.The granite/trap/basalt crushed graded coarse aggregates and fine aggregates as per relevant IS Codes machine mixed with super plasticizers laid in finished layers, well compacted using needle vibrators, including all lead & lifts, cost of all materials, quality confirming to the requirements of relevant IS codes,labour, Usage charges of machinery, curing and all the other appurtenances required to complete the work as per technical specifications. (M20 Design Mix Using 20 mm nominal size graded crushed coarse aggregates (Item No. 2.2.1 Page No. 15 Vol.1 Common SR & Appendix I page No.111)	Cum	11.15	
code69	Supplying, fitting and placing TMT FE 550 / 550D Steel Reinforcement including cost of all materials, machinery, labour, cleaning, straightening, cutting, bending, hooking, laping/welding joints, tying with binding wire / soft annealed steel wire and other ancillary operations complete as per drawing and technical specification. Buildings (Item No. 2.11a Page No. 18 Vol.1 Common SR)	Tonne	1.027	
code70	Providing Size Stone masonry with hard stone in foundation & plinth with Cement mortar 1:6 (1 cement : 6 coarse sand) (CSR 2023-24, Volume- II It No 5.4 Page No 9)	Cum	15.37	
code71	Filling available excavated earth (excluding rock) in trenches, plinth, sides of foundations and other similar works etc. in layers not exceeding 20cm in depth, consolidating each deposited layer by ramming and watering, lead up to 50 m and lift upto 1.5 m. (PWD CSR 2023-24, Volume-I It No 1.9 Page No 7)	Cum	22.72	

ITEM CODE	DESCRIPTION	UNIT	QUANTITY	RATE EXCLUDING GST COST (IN INR)
code72	Providing and Filling in foundation with granite / trap broken metal 100mm. anddown size & with approved sand including hand packing, ramming, watering,including cost of all materials and labour with all lead and lift complete as perspecifications. (CSR 2023-24, Volume-I It No 1.23 Page No 11)	Cum	15.15	
code73	Providing and constructing laterite size stone masonry including cost and conveyance of all materials curing etc complete as per specification. I.S. 3620/1979 having compressive strength not less then 3.5 N/mm2 for saturated dry samples. For Superstructure in CM 1:6 1st Corrigendum and Addendum order - 21-04-2022(PWD CSR 2023-24, Volume-II It No 5.7 Page No 9)	Cum	22.36	
code74	Providing 20 mm cement plaster of mix :1:4 (1 cement: 4 fine sand) to brick/stone masonry including rounding off corners wherever required smooth rendering, providing and removing scaffolding, including cost of materials, labour, curing complete as per specifications and as per directions of Engineer-in-charge.(Item No. 8.3.1, Page No. 41, Vol.2)	Sqm	189	
code75	Providing White washing with lime to give an even shade :New work(three coats) with lime of approved quality, including cost of materials, labour complete as per specifications and as per directions of Engineer in-charge.(Item No. 8.21, Page No. 44, Vol.2)	Sqm	189	
code76	Finishing walls with water proofing cement paint of required shade :New work (Two coats applied @ 4.84 kg/10 m ²) to give an even shade after thoroughly brooming the surface to remove all dirt, dust, mortar drops and foreign matter including preparing the surface even and sand paper smooth, cost of materials, labour complete as per specifications and as per directions of Engineer-in-charges.(Item No. 8.28, Page No. 45, Vol.2)	Sqm	189	

ITEM CODE	DESCRIPTION	UNIT	QUANTITY	RATE EXCLUDING GST COST (IN INR)
code77	Providing and laying vitrified floor tiles with thickness 9-10 mm indifferent sizes with water absorption less than 0.08% and conforming to IS: 15622, of approved make, in all colours and shades, laid on 20mm thick cement mortar 1:4 (1 cement : 4 coarse sand), jointing with grey cement slurry @ 3.3 kg/ m ² including grouting the joints with white cement and matching pigments etc., complete Size of Tile 600x600 mm (Item No. 9.12.2 Page No. 60 Vol.2 PWD SR)	sqm	46.13	
code78	Providing and fixing 1mm thick M.S. sheet door with frame of 40x40x6mm angle iron and 3 mm M.S. gusset plates at the junctions and corners, all necessary fittings complete, including applying a priming coat of approved steel primer. Using M.S. angles 40x40x6 mm for diagonal braces including cost of materials, labour, usage charges of machinery complete as per specifications and as per directions of the Engineer-in-Charge. (Item No. 11.5.1, Page No. 77, Vol.2)	Sqm	7.56	
code79	Providing Honne wood frames of doors, windows, clerestory windows, ventilators and other frames, wrought, framed or assembled including making plaster grooves (excluding cost of cement concrete and side clamps), but including cost of materials, labour, usage charges complete as per specifications. (PWD CSR 2023-24 VOLUME 2, Item No 12.11 page -99)(door)	Cum	0.21	

ITEM CODE	DESCRIPTION	UNIT	QUANTITY	RATE EXCLUDING GST COST (IN INR)
code80	Providing & fixing of 2-track x 2-panel sliding windows made out of multi chambered UPVC(Matching to RAL-9016) sections and with minimum TiO2(Titanium Dioxide) at 6PHR with TPE(Thermo Plastic Elastomer) and lead free, gaskets -grey colour having isolated drainage and reinforced with Galvanized Iron profile through-out the window frame. The outer frame having a overall size of 60mm width x 45mmheight with reinforcement of 1mm thickness and Sash with overall size of 39mm X 58mm with GI reinforcement of 1mm for the frame and 1.5 mm for the sash. Coextruded Glazing bead for fixing of glass shall be of size 20mm x 24mm. Windows shall be provided with 5mm plain float glass, standard hardware& single point locking system with touch lock. Wall thickness of frame & sash shall be of 2-2.5 mm. Maximum possible size- 1819mm x 1819mm (The cost is inclusive of all fixtures and separate charges for minor T&Ps shall not be made)(PWD CSR 2023-24 VOLUME 2,Item No 12.88 page - 110)	Sqm	6.75	
code81	Providing and fixing M.S. grills of required pattern in frames of windows etc. with M.S. flats, square or round bars etc. including priming coat with approved steel primer all complete. Fixed to steel windows by welding.(Item No. 11.34A, Page No. 86, Vol.2)	Kg	78	
code82	Providing & fixing of louvered ventilator made out of multi chambered UPVC(Matching to RAL-9016) sections and with minimum TiO2(Titanium Dioxide) at 6PHR with TPE(Thermo Plastic Elastomer) and lead free with gaskets -grey colour having isolated drainage and reinforced with Galvanized Iron profile through out the ventilator frame. The frame having overall size of 39mm x 39mm with GI reinforcement of 1mm thickness. Louver clip in Aluminium (powder coated in white will be used on the frame along with plastic parts for fixing the 4 mm pin head glass.Wall thickness of frame shall be 2mm.Maximum possible size 1000mm x 1000mm.(The cost is inclusive of all fixtures and separate charges for minor T&P's shall not be made)(PWD CSR 2023-24 VOLUME 2,Item No 12.85 page -109)	sqm	2.88	

ITEM CODE	DESCRIPTION	UNIT	QUANTITY	RATE EXCLUDING GST COST (IN INR)
code83	CC Road : Scarifying the existing Granular road surface to a depth of 50 mm and disposal of scarified material by Mechanical Means using Hydraulic excavator with in all lifts and lead(pwdcscr 2023-24 volume 3, item no 3.4 page 17	Sqm	1200	
code84	Construction of Embankment by excavating the available approved Gravel/Murrum deposited at a place or borrow pits during or prior excavation with all lifts and lead, transportation to site, spreading, grading to required slope and compacting to meet the requirement complete as per specifications, including cost of labour,rolling,water,allmaterials,usage& all other appurtenaces required to complete the work.(Volume-I It No 1.8 page no 7 PWD CSR 2023-24)	cum	400.5	
code85	Wet Mix Macadam (Plant Mix Method) : Providing, laying, spreading and compacting graded stone aggregate to wet mix macadam specification including premixing the Material with water at OMC in mechanical mix plant carriage of mixed Material by tipper to site, laying in uniform layers with paver/grader in sub-base / base course on well prepared surface and compacting with vibratory roller to achieve the desired density (Volume-3 It No 4.17 page no 26 PWD CSR 2023-24)	cum	180	
code86	Providing, laying, spreading and compacting stone aggregates of specific sizes to water bound macadam specification including spreading in uniform thickness, hand packing, rolling with vibratory roller in stages to proper grade and camber, applying and brooming requisite type of screening/ binding Materials to fill up the interstices of coarse aggregate, watering and compacting to the required density. Using Screening Crushable type such as Moorum or Gravel (Volume-III It no 4.13 A[a] page no 25 PWD CSR 23-24)	cum	90	

ITEM CODE	DESCRIPTION	UNIT	QUANTITY	RATE EXCLUDING GST COST (IN INR)
code87	<p>Providing and constructing un-reinforced plain cement concrete pavement, thickness as per design, over a prepared sub base, with 43 grade cement or any other type as per Clause 1501.2.2 M20 (Grade), coarse and fine aggregates conforming to IS:383:2016, maximum size of coarse aggregate not exceeding 25 mm, mixed in a concrete mixer of not less than 0.2 cum capacity and appropriate weigh batcher using approved mix design, laid in approved fixed side formwork (steel channel, laying and fixing of 125 micron thick polythene film, wedges, steel plates including levelling the formwork as per drawing), spreading the concrete with shovels, rakes, compacted using needle, screed and plate vibrators and finished in continuous operation including construction joints, , primer, sealant , curing of concrete slabs for 14-days, and water finishing to lines and grade as per drawing and technical specification clause 1501 with all lead, lifts, loading & unloading charges, cost and conveyance of all materials, labour, equipments etc., complete. as per the directions of the Engineer-in-charge of the work. (Volume-III It no 16.27 page no 148 PWD CSR 2023-24)</p>	cum	168.75	
code88	<p>Providing and fixing RCC name board of size 1.35x0.60x0.04 m fixed in reinforced cement concrete poles of size 0.10x0.10x2.60m in cement concrete M 20 proportion using 20mm and down size graded metal machine mixed with 10mm dia main steel bars and 8mm diastirpes as shown in drawing. The board shall be provided with 12mm thick cement plaster in cement mortar 1:4 on both the sides. The poles shall be embedded in the ground for a depth of 0.5 m with cement concrete M 10 proportion. The board shall be fixed as per the drawing and at the place indicated by the Engineer in charge of the work. The cost includes excavation, cost of all materials, cost of steel, painting, centering, ransportation charges & fixing charges.(Volume-III It No 8.55 P.no 79 PWD CSR 2023-24)</p>	each	1	

ITEM CODE	DESCRIPTION	UNIT	QUANTITY	RATE EXCLUDING GST COST (IN INR)
code89	Rain water harvesting: Earth work excavation by manual means for drains, canals, waste weir draft, approach channels, key trench, foundation of Bridges and such similar works, as per drawing and technical specifications, including setting out, shoring, strutting, barricading, caution lights, excavated surface leveled and sides neatly dressed disposing off or leveling the excavated stuff or sorting & stacking the selected stuff for reuse in a radius of 50 m and lift upto 1.5 m including cost of labour, tools, usage & other appurtenances required to complete the work. Depth exceeding 1.5m, but not exceeding 3 m (CSR 20223-24 Vol-1 Item No 1.5.2, Page 6)	cum	99.06	
code90	Providing and laying in position Cement Concrete for all Foundation works. The granite/trap/basalt crushed graded coarse aggregates and fine aggregates as per relevant IS Codes machine mixed with super plasticizers laid in finished layers, well compacted using needle vibrators, including all lead & lifts, cost of all materials, quality confirming to the requirements of relevant IS codes, labour, Usage charges of machinery, curing and all the other appurtenance required to complete the work as per technical specifications. 2.2.1 M20 Design Mix Using 20 mm nominal size graded crushed coarse aggregates (CSR 20223-24 Vol-1 Item No 2.2.1, Page 15)	cum	1.667344	
code91	Supplying, fitting and placing TMT FE 550 / 550D Steel Reinforcement including cost of all materials, machinery, labour, cleaning, straightening, cutting, bending, hooking, laping/welding joints, tying with binding wire / soft annealed steel wire and other ancillary operations complete as per drawing and technical specification (Item No. 2.11a Page No. 18 Vol.1 CSR 2023-24)	Tonne	0.06	
code92	Granular Aggregate - 40 mm downsize (CSR 2023-24 Vol-1 Item No. 7, Page A-38)	cum	21.02	
code93	Granular Aggregate - 20 mm downsize (CSR 2023-24 Vol-1 Item No. 4, Page A-38)	cum	5	

ITEM CODE	DESCRIPTION	UNIT	QUANTITY	RATE EXCLUDING GST COST (IN INR)
code94	Providing and installing at site of work P.V.C. pipes including cost of pipes and specials and labour, including lowering into trenches, laying true to line, level and perfect linking at joints leak proof including jointing of approved type with all labour charges and all lift charges, handling charges including encasing the pipe around to a depth not less than 15 cms with gravel or selected earth available from the excavation etc. complete. (CSR 2023-24, Vol-5 Page 120, Item No. 10.14.3)	m	303	
code95	Providing Brick work with common burnt clay Non Modular bricks of class designation 3.5 in foundation and plinth in Cement mortar 1:4 (1 cement : 4 coarse sand) including cost of all materials, labour, scaffolding and usage charges of machinery & other incidental charges complete as per the direction of engineer incharge of work. (CSR 2023-24, Vol-II Page 13, Item No. 6.1)	cum	0.58	
code96	Providing 12 mm cement plaster with Cement mortar 1:3 (1 cement: 3 coarse sand) finished with a floating coat of neat cement to brick masonry including rounding off corners wherever required smooth rendering, providing and removing scaffolding, including cost of materials, labour, curing complete as per specifications and as per directions of Engineerin- charge. CSR 2023-24 Vol-2 Item No8.6.1 Page 42)	sqm	12.8	
code97	Distempering with oil bound washable distemper of approved brand and manufacture to give an even shade :New work (two coats) over and including water thinnable priming coat with cement primer after thoroughly brooming the surface to remove all dirt, dust, mortar drops and foreign matter including preparing the surface even and sand paper smooth, cost of materials, labour complete as per specifications and as per directions of Engineer-in-charge. CSR 2023-24 Vol-2 Item No8.25 Page 45)	sqm	8.96	

ITEM CODE	DESCRIPTION	UNIT	QUANTITY	RATE EXCLUDING GST COST (IN INR)
code98	Internal electrification works: Open Conduit System : Supplying heavy gauge PVC conduit pipe 19/20 mm dia 2 mm thick confirming to IS 2509 with suitable size bends, junction boxes, adhesive paste etc, and fixing using inverted wood plugs in case of RCC ceiling and RCC wall / stone structure or rawl plugs in case of brick walls and cement plastering the damaged portion using heavy gauge saddles at an interval of 700 mm using NF screws. (Vol-06, item no 1.1.1 PWD Ele SR. 2023-24 Part- III)	m	20	
code99	Concealed Conduit System : Supplying heavy gauge PVC conduit pipe 25 mm dia 2 mm thick confirming to IS 2509 with suitable size bends, metal / PVC junction boxes, adhesive paste etc, and running before concreting the slab. The conduit should be tied to the reinforcement rods by using binding wires and unused ways of junction boxes and pipe ends should be covered using PVC end enclosures, run with 18SWG GI fish wire wherever necessary (Vol-06, item no 1.2.2 PWD Ele SR. 2023-24 Part- III)	m	135	
code100	Groove cutting : Supplying heavy gauge PVC Conduit Pipe 25 mm dia 2 mm thick with suitable size bends, metal junction boxes adhesive paste etc by groove cutting in the wall and fixing by bracing U or J hooks and cement plastering up to the wall surface and run with 18 SWG GI fish wire run through out the conduit wherever necessary. (Vol-06, item no 1.3.2 PWD Ele SR. 2023-24 Part- III)	m	135	
code101	Supplying and fixing PVC/metal conduit 19/20 mm Deep junction box (Vol-06, item no 1.5.1 PWD Ele SR. 2023-24 Part- III)	Each	8	
code102	Supplying and fixing PVC/metal conduit 25 mm Deep junction box (Vol-06, item no 1.5.2 PWD Ele SR. 2023-24 Part- III)	Each	52	

ITEM CODE	DESCRIPTION	UNIT	QUANTITY	RATE EXCLUDING GST COST (IN INR)
code103	Point wiring using Copper wire without switch: Supplying and wiring adopting loop system in existing PVC Conduit / casing capping using 2 x 1.5 mm ² (Phase & Neutral) & 1x1.0 mm ² (Earth wire) FRLS multi strand PVC insulated copper wire (confirming to IS-694: and latest amendments) with a 6A flush type SP control switch shall be fixed on the existing plastic sheet/ gang box the other end of the wires shall be terminated with sufficient loose length in a wood/PVC round block complete for each outlet - Short point upto 3Mtr from tapping point to out let via switch. (Vol-06, item no 2.2.1 PWD Ele SR. 2023-24 Part- III)	Point	10	
code104	Point wiring using Copper wire without switch: Supplying and wiring adopting loop system in existing PVC Conduit / casing capping using 2 x 1.5 mm ² (Phase & Neutral) & 1x1.0 mm ² (Earth wire) FRLS multi strand PVC insulated copper wire (confirming to IS-694: and latest amendments) with a 6A flush type SP control switch shall be fixed on the existing plastic sheet/ gang box the other end of the wires shall be terminated with sufficient loose length in a wood/PVC round block complete for each outlet - Medium point above 3Mtr upto 6Mtr from tapping point to out let via switch. (Vol-06, item no 2.2.2 PWD Ele SR. 2023-24 Part- III)	Point	24	
code105	Point wiring using Copper wire without switch: Supplying and wiring adopting loop system in existing PVC Conduit / casing capping using 2 x 1.5 mm ² (Phase & Neutral) & 1x1.0 mm ² (Earth wire) FRLS multi strand PVC insulated copper wire (confirming to IS-694: and latest amendments) with a 6A flush type SP control switch shall be fixed on the existing plastic/ gang box the other end of the wires shall be terminated with sufficient loose length in a wood/PVC round block complete for each outlet -Long point above 6Mtr upto 10Mtr from tapping point to out let via switch. (Vol-06,item o 2.2.3 PWD Ele SR. 2023-24 Part- III)	Point	26	

ITEM CODE	DESCRIPTION	UNIT	QUANTITY	RATE EXCLUDING GST COST (IN INR)
code106	Supplying and flush mounting powder coated / galvanized 1-2 Way metal box suitable for mounting modular switch plates. The box should be firmly flush mounted after due groove cutting in Brick / Stone/ C.C wall (Vol-06, item no 3.4.1 PWD Ele SR. 2023-24 Part- III)	Each	2	
code107	Supplying and flush mounting powder coated / galvanized 3 Way metal box suitable for mounting modular switch plates. The box should be firmly flush mounted after due groove cutting in Brick / Stone/ C.C wall (Vol-06 item no 3.4.2, PWD Ele SR. 2023-24 Part- III)	Each	2	
code108	Supplying and flush mounting powder coated / galvanized 6 Way metal box suitable for mounting modular switch plates. The box should be firmly flush mounted after due groove cutting in Brick/ Stone/ C.C wall (Vol-06, item no 3.4.4 PWD Ele SR. 2023-24 Part- III)	Each	2	
code109	Supplying and flush mounting powder coated / galvanized 8 Way metal box suitable for mounting modular switch plates. The box should be firmly flush mounted after due groove cutting in Brick/ Stone/ C.C wall (Vol-06,item no 3.4.5 PWD Ele SR. 2023-24 Part- III)	Each	2	

ITEM CODE	DESCRIPTION	UNIT	QUANTITY	RATE EXCLUDING GST COST (IN INR)
code110	Supplying and flush mounting powder coated / galvanized 10-12 Way metal box suitable for mounting modular switch plates. The box should be firmly flush mounted after due groove cutting in Brick/ Stone/ C.C wall (Vol-06, item no 3.4.6 PWD Ele SR. 2023-24 Part- III)	Each	1	
code111	Supplying and fixing superior quality modular switch mounting 1 to 2 Module polycarbonate plate with necessary supporting back plate with required nos. of machine screws, bolts nuts etc., complete on the existing metal/ PVC box. (Vol-06,item no 3.5.1 PWD Ele SR. 2023-24 Part- III)	Each	2	
code112	Supplying and fixing superior quality modular switch mounting 3 Module polycarbonate plate with necessary supporting back plate with required nos. of machine screws, bolts nuts etc., complete on the existing metal/ PVC box. (Vol-06, item no 3.5.2 PWD Ele SR. 2023-24 Part- III)	Each	2	
code113	Supplying and fixing superior quality modular switch mounting 6 Module polycarbonate plate with necessary supporting back plate with required nos. of machine screws, bolts nuts etc., complete on the existing metal/ PVC box. (Vol-06, item no 3.5.4 PWD Ele SR. 2023-24 Part- III)	Each	2	

ITEM CODE	DESCRIPTION	UNIT	QUANTITY	RATE EXCLUDING GST COST (IN INR)
code114	Supplying and fixing superior quality modular switch mounting 8 Module polycarbonate plate with necessary supporting back plate with required nos. of machine screws, bolts nuts etc., complete on the existing metal/ PVC box. (Vol-06, item no 3.5.5 PWD Ele SR. 2023-24 Part- III)	Each	2	
code115	Supplying and fixing superior quality modular switch mounting 10-12 Module polycarbonate plate with necessary supporting back plate with required nos. of machine screws, bolts nuts etc., complete on the existing metal/ PVC box. (Vol-06, item no 3.5.6 PWD Ele SR. 2023-24 Part- III)	Each	1	
code116	Supplying and fixing of modular switch & connected accessories on existing modular switch plate as per IS 3854 and IS 1293 -6A One Way Switch (Vol-06,item no 3.6.1 PWD Ele SR. 2023-24 Part- III)	Each	60	
code117	Supplying and fixing of modular switch & connected accessories on existing modular switch plate as per IS 3854 and IS 1293 -6A Three Way socket (Vol-06,item no 3.6.3 PWD Ele SR. 2023-24 Part- III)	Each	9	
code118	Supplying and fixing of modular switch & connected accessories on existing modular switch plate as per IS 3854 and IS 1293 -Stepped Fan Regulator Two Module (Vol-06, item no 3.6.4 PWD Ele SR. 2023-24 Part- III)	Each	1	

ITEM CODE	DESCRIPTION	UNIT	QUANTITY	RATE EXCLUDING GST COST (IN INR)
code119	Supplying and fixing of modular switch & connected accessories on existing modular switch plate as per IS 3854 and IS 1293 -16A One Way Switch (Vol-06, item no 3.6.7 PWD Ele SR. 2023-24 Part- III)	Each	6	
code120	Supplying and fixing of modular switch & connected accessories on existing modular switch plate as per IS 3854 and IS 1293 -6/16A Universal Socket (Vol-06, item no 3.6.10 PWD Ele SR. 2023-24 Part- III)	Each	10	
code121	Supplying and fixing/ replacing of 6/ 16/ 32A electrical accessories on existing switch board - 6A Bakelite Ceiling Rose (Vol-06, item no 3.14.5 PWD Ele SR. 2023-24 Part- III)	No	4	
code122	Wiring for lighting/power circuit using one of FRLS PVC insulated 1100V grade, multistrand copper wire with low conductor resistance single core in open or concealed system of wiring with specified IS - 694 : confirming to latest ammendments -1.5 mm2 (Vol-06, item no 2.3.2 PWD Ele SR. 2023-24 Part- III)	m	360	
code123	Supplying and fixing 6-32 A SP miniature circuit breakers on existing MCB distribution boards using necessary fixing materials and C Type curve, indicator ON/OFF, energy cross-3 with Short circuit breaking capacity of 10K and complete wiring as required confirming to IEC 60898. (Vol-06, item no 5.18.1 PWD Ele SR. 2023-24 Part- III)	Each	12	

ITEM CODE	DESCRIPTION	UNIT	QUANTITY	RATE EXCLUDING GST COST (IN INR)
code124	Supplying and fixing 6-32 A DP miniature circuit breakers on existing MCB distribution boards using necessary fixing materials and C Type curve, indicator ON/OFF, energy cross-3 with Short circuit breaking capacity of 10K and complete wiring as required confirming to IEC 60898. (Vol-06, item no 5.18.4 PWD Ele SR. 2023-24 Part- III)	Each	9	
code125	Supplying and fixing 6-32 A TPN miniature circuit breakers on existing MCB distribution boards using necessary fixing materials and C Type curve, indicator ON/OFF, energy cross-3 with Short circuit breaking capacity of 10K and complete wiring as required confirming to IEC 60898. (Vol-06, item no 5.18.7 PWD Ele SR. 2023-24 Part- III)	Each	18	

ITEM CODE	DESCRIPTION	UNIT	QUANTITY	RATE EXCLUDING GST COST (IN INR)
code126	Supplying and fixing Moulded Case Circuit Breaker (MCCB) over the existing wood /panel board using necessary screws, bolts, nuts, necessary phaseseparators, handle and wiring complete. Protection of Overload and Short circuit in Thermal Magnetic Release. Micro processor release shall have Earth Fault as per IS- 13947 (Icu= 100% Ics) In 4 PMCCB all Poles should have protection for Short-Cicrcuit/ Over Load. For Microprocessor MCCBS Facility for segregating Priority and Non-Priority loads must be available in the MCCB. MCCB shall be provided with double insulation (insulation between front cover and internal power circuits to avoid any accidental contact with live current carrying path with the front cover open). Multi-pole breakers shall be designed to break all the poles simultaneously and they shall have a single mechanism- FOUR Pole - 125 A 25 kA (Vol-06, item no 5.15.10 PWD Ele SR. 2023-24 Part- III)	Each	2	
code127	Wiring for lighting/power circuit using one of FRLS PVC insulated 1100V grade, multistrand copper wire with low conductor resistance single core in open or concealed system of wiring with specified IS - 694 : confirming to latest ammendments -2.5 mm2 (Vol-06,item no 2.3.3 PWD Ele SR. 2023-24 Part- III)	m	1980	
code128	Supplying and fixing of 32Amps, 3pole+ earth 440V metal clad Industrial Sockets. (Vol-06, item no 3.13.8 PWD Ele SR. 2023-24 Part- III)	Each	8	

ITEM CODE	DESCRIPTION	UNIT	QUANTITY	RATE EXCLUDING GST COST (IN INR)
code129	Wiring for lighting/power circuit using one of FRLS PVC insulated 1100V grade, multistrand copper wire with low conductor resistance single core in open or concealed system of wiring with specified IS - 694 : confirming to latest ammendments -4 mm2 (Vol-06,item no 2.3.4 PWD Ele SR. 2023-24 Part- III)	m	879	
code130	Supplying and fixing of LED type panel board indicating lamp with required colour suitable for 230/ 440V A.C. 50 Hz 12/ 24V D.C. (Vol-06, item no 5.38 PWD Ele SR. 2023-24 Part- III)	Each	6	
code131	Supply and fixing 15 inch x 12 inch x 2 inch polished wood board made of not less than 15 mm thick plank on both sides of not more than 2 pieces and fixing the same to the wall using tapered inverted wooden plugs screws (Vol-06, item no 5.6.5 PWD Ele SR 2023-24 Part- III)	Each	1	
code132	Fabricating supplying and mounting MS box made out 16 SWG suitable for floor / wall mounting, fully weather proof with provision for better heat dissipation, provided with hinged front cover, equipped with tamper proof locking arrangements, with suitable size clamps with necessary cable entry pipe with gland and box should be finished with 7tanks treatment with powder coated paint and finally finished with approved colour etc., complete. (Vol-06,item no 5.42.2 PWD Ele SR. 2023-24 Part- III)	sq CM	70000	

ITEM CODE	DESCRIPTION	UNIT	QUANTITY	RATE EXCLUDING GST COST (IN INR)
code133	Wiring for lighting/power circuit using one of FRLS PVC insulated 1100V grade, multistrand copper wire with low conductor resistance single core in open or concealed system of wiring with specified IS - 694 : confirming to latest ammendments -10 mm2 (Vol-06,item no 2.3.6 PWD Ele SR. 2023-24 Part- III)	m	720	
code134	Supplying and fixing 50 x 50 x 6 mm angle iron frame work fabricated out of M.S. angle iron and M.S. flat ... with bolts, washers etc and painted with 2 coats of red oxide and then two coats of approved paint. (Vol-06, PWD Ele SR. 2023-24 Part- III item no 5.41.2)	m	20	
code135	Supplying 100 A 4 x 30 x 6 mm Aluminium Strips rated 3phase with neutral bus bar using required capacity electrolytic aluminum strips covered with heat shrinkable coloured PVC sleeve, mounted on phenolic/ FRP/ DMC insulator which are mounted on powder coated 40x6mm M.S. flat frame work in existing panel board. The bus bar shall have suitable holes for termination of incoming and outgoing cables as per IS specification with necessary bolts, nuts and washers etc complete. (Vol-06, PWD Ele SR. 2023-24 Part- III item no 5.40.1)	m	25	

ITEM CODE	DESCRIPTION	UNIT	QUANTITY	RATE EXCLUDING GST COST (IN INR)
code136	Labour charges for erection of indoor type panel board and meter board units with all necessary materials and labour tools and equipments including cement concrete for foundation/bed etc,complete as per specification, with testing of as per instructions of engineer incharge of work. (item no 13.33 Vol-05, WS & SW SR 2023-24 Page No. 156)	job	6	
code137	Supplying capacitor type 48 Sweep (1200 mm) Regular model ceiling fan complete with down rod blades, shackle, canopies etc for operation on 230V, 50 cycles. Single phase AC supply conforming to ISS- 374- 1979 and with double ball bearing system. (item no 6.3.1 Vol-06, PWD Ele SR. 2023-24 Part- III)	Each	1	
code138	Supplying of ... feet - PVC Batten with integrated LED tube ...W with high quality diffuser with Life of 25000 burning hours & 70% lumen maintenance with CRI greater than 80. Power Input: 220-240V @ 50/60Hz & Power factor greater than 0.9 along with CE approved. 2 years Warranty against any manufacturing defect working under standard electrical condition -LED light fitting 1 x 4 - 20/22 W (ite no 11.3.2 Vol-06, PWD Ele SR. 2023-24 Part- III)	Each	5	

ITEM CODE	DESCRIPTION	UNIT	QUANTITY	RATE EXCLUDING GST COST (IN INR)
code139	<p>Supply of LED floodlight 70W luminaire with pressure die cast aluminium housing body for optimal thermal dissipation. Lamp compartment comprising of anti glare clear diffuser with Injection moulded polycarbonate / clear glass material, delivering superior light output. Rated life Burning Hrs 50000 hr @ Lumen Maintenance of 70% CCT greater than 5500K, IP 66 optical and electrical compartment & impact resistance of complete luminaire greater than IK08. Power Factor greater than 0.9 with mains, Surge Protection- Min 5KV alongwith Over voltage/ Overload, short circuit/ miss-wiring protection. Compatible for pole mouting with outer dia of 40mm to 50mm. Universal Voltage driver to operate wide voltage range from 100V to 270V 50/ 60Hz application. Complianc to IS 10322/IEC 60598, LM 79 & LM 80 Adherence with RoHS. UL approved MCPCB. Top access street light with single screw to ensure ease of maintenance at the sight site location with minimized minimal tools. LED Light fixture with ...W System Power consumption. LED Efficiency greater than 130 lm/w, nominal CRI greater than 75. Luminaire manufacturer should have inhouse facility accredited by NABL/ CPRI & any Government certified agency & Design & Development facility certified by ISO 9001: 2008 . Housing with supplier word mark/ name shall be Engraved/ Embossing on the die cast housing/ Body part. Warranty of 2Years against any manufacturing defect working under standard electrical conditions as mentioned above should be given by LED manufacturer & Cree/ Nichia/ Lumileds/ Osram make LED Source. (item no 11.9.1 Vol-06, PWD Ele SR. 2023-24 Part- III)</p>	Each	22	
code140	<p>Supplying and fixing of LED bulk head of 10W with IP65 protection and IK 08 impact resistance suitable for surface and wall mounting application (item no 11.15 Vol-06, PWD Ele SR. 2023-24 Part- III)</p>	Each	4	

ITEM CODE	DESCRIPTION	UNIT	QUANTITY	RATE EXCLUDING GST COST (IN INR)
code141	<p>Supply of LED Streetlight 40W luminaire with pressure die cast aluminium housing body for optimal thermal dissipation. Lamp compartment comprising of anti glare clear diffuser with Injection moulded polycarbonate material, delivering superior light output. Rated life Burning Hrs 50000 hr @ Lumen Maintenance of 70%, maximum light intensity should be between 60 degrees to 70 degrees. CCT greater than 5500K, IP 66 optical and electrical compartment & impact resistance of complete luminaire greater than IK08. Power Factor greater than 0.9 with mains, Surge Protection- Min 5KV along with Over voltage/ Overload, short circuit/ miss- wiring protection. Compatible for pole mounting with outer dia of 40mm to 50mm. Universal Voltage driver to operate wide voltage range from 100V to 270V 50/ 60Hz application. Compliance to IS 10322/ IEC 60598, LM 79 & LM 80 Adherence with RoHS. UL approved MCPCB. Top access street light with single screw to ensure ease of maintenance at the sight site location with minimized minimal tools. LED Light fixture with ...W System Power consumption. LED Efficiency greater than 130 lm/w, nominal CRI greater than 75. Luminaire manufacturer should have inhouse facility accredited by NABL/ CPRI & any Government certified agency & Design & Development facility certified by ISO 9001: 2008 . Housing with supplier word mark/ name shall be Engraved/ Embossing on the die cast housing/ Body part. Warranty of 2 Years against any manufacturing defect working under standard electrical conditions as mentioned above should be given by LED manufacturer & Cree/Nichia/Lumileds/Osram make LED Source. (item no 11.8.2 Vol-06, PWD Ele SR. 2023-24 Part- III)</p>	No	2	
code142	<p>Supplying and drawing 3 core flat PVC sheathed submersible pump cable manufactured with electrolytic grade copper with flexible copper with low resistance conductor confirming to IS : 8130 -1984 and virgin grade PVC insulation and powder coating extruded PVC sheathed suitable for working voltage upto 1100Volts as per IS - 694 : 2010 - 3C x 4 mm2 (item no 2.6.2 Vol-06, PWD Ele SR. 2023-24 Part- III)</p>	m	30	

ITEM CODE	DESCRIPTION	UNIT	QUANTITY	RATE EXCLUDING GST COST (IN INR)
code143	GI/Copper strips for grounding connections, using necessary fixing materials as required- 25 x 3 mm Copper strip (item no 12.58.7 Vol-06, PWD Ele SR. 2023-24 Part-III)	m	70	
code144	1.1kV, XLPE or Heat resistant PVC insulated, PVC extruded Inner SeathArmoured LT UG Cable as per IS-1554 (Part-1) or IS- 7098 Part-1, Armouring strip thickness and resistivity as per IS-3975- 70 Sqmm, 3.5 Core, (18 GI Strips - 4 x 0.8 mm) (Vol-06, ESCOMs SR. 2023-24 Part- II, Page No. 13 - Item No 32.13)	KM	0.123	
code145	Straight Through Jointing Kit -70 Sqmm, 3.5/4 Core, Suitable for 1.1 kV Class LTUG Cable as per IS-13573- Epoxy Type (Vol-06, ESCOMs SR. 2023-24 Part- II item no 34.08)	Set	4	
code146	1.1kV, XLPE or Heat resistant PVC insulated, PVC extruded Inner SeathArmoured LT UG Cable as per IS-1554 (Part-1) or IS- 7098 Part-1, Armouring strip thickness and resistivity as per IS-3975- 95 Sqmm, 3.5 Core, (21 GI Strips - 4 x 0.8 mm) (Vol-06, ESCOMs SR. 2023-24 Part- II, Page No. 13 - Item No 32.14)	KM	0.057	
code147	Straight Through Jointing Kit -95 Sqmm, 3.5/4 Core, Suitable for 1.1 kV Class LTUG Cable as per IS-13573- Epoxy Type (Vol-06, ESCOMs SR. 2023-24 Part- II item no 34.09)	Set	2	

ITEM CODE	DESCRIPTION	UNIT	QUANTITY	RATE EXCLUDING GST COST (IN INR)
code148	Laying of cable in Existing Trench/ GI pipe/ Stone Ware/ RCC Hume pipe using Wooden /Aluminum Rollers as directed by the departmental staff- LT Cable - 35 to 95 Sqmm (Vol-06, ESCOMs SR. 2023-24 Part- II litem no 21.06)	KM	0.18	
code149	Heavy Duty 70 Sqmm Copper Terminal Long Barrel, ApprxWt: 38 Gm (Vol-06, ESCOMs SR. 2023-24 Part- II item no 59.04)	No	12	
code150	Heavy Duty 95 Sqmm Copper Terminal Long Barrel, ApprxWt: 58 Gm (Vol-06, ESCOMs SR. 2023-24 Part- II item no 59.05)	No	8	
code151	Providing, Laying and Fixing of Heavy Duty GI pipe of 40mm dia conforming to IS 1239:1990 with latest amendments complete with GI fittings (excluding the cost of fittings) with cuts and threads wherever necessary, including testing for water tightness, with all lead and commissioning. (contractor will make his own arrangements for procuring water for testing) For: Heavy Duty GI Pipe etc. complete. (Vol-05, WS & SW SR 2023-24 item no 11.3.5 Page No. 128)	m	30	
code152	CT Ratio - 50/5A, 0.5 Accuracy Class, LT Current Transformer, 3.75 VA, Ring type as per IS-2705 Part-1&2 (Vol-06, ESCOM's SR. 2023-24 Part- II item no 56.05)	No	3	

ITEM CODE	DESCRIPTION	UNIT	QUANTITY	RATE EXCLUDING GST COST (IN INR)
code153	Supplying, fixing, wiring, earth electrode for grounding conduits, I.C. cutouts and other equipment's on the meter board using 40mm dia 2.90mm thick GI pipe 2.5m long buried in a pit. The pit should be filled with equal proportion of salt and charcoal 150 mm all-round the pipe to complete depth. The connection from the pipe to the conduit etc., is to be established through GI wire of size as per ISI specification 7.3.3. of IS732 using 12mm dia bolts, nuts, washers and check nuts etc., the pipe shall have 16 through holes of 12 mm dia (Vol-06, PWD Ele SR 2023-24 Part- III item no 12.56)	No	6	
code154	Supply and delivery at site special moulded variety 75mm dia PVC Bend as per IS 7834/ 1987 and fabricated as per IG124/ 1984 with ISI mark with its latest amendments. (Vol-05, WS & SW SR 2023-24 Page No. 118 item no 10.11.6)	Each	48	
code155	Providing 75mm dia UNPLASTICISED PVC pipes conforming to IS 16098 : 2013 with latest amendments ended with integral sockets with ISI mark and conveying to worksite, rolling and lowering into trenches, laying true to line and level and perfect linking at joints, testing and commissioning, including loading and unloading at both destinations and cuts of pipes wherever necessary including jointing of UPVC pipes (with cost of elastomeric sealing rings) and specials (excluding cost of specials) with jointing of approved type, with all labour, lead & lifts, including encasing the pipes allround to a depth of not less than 15 cms. with soft gravel or selected earth available from the excavation etc. complete and giving necessary hydraulic test to the required pressure as per ISS (contractor will make his own arrangements for procuring water for testing) etc. complete for : Pipes of SN 4, 75mm dia. (Vol-05, WS & SW SR. 2023-24 item no 10.2.1 Page No. 114)	m	195	

ITEM CODE	DESCRIPTION	UNIT	QUANTITY	RATE EXCLUDING GST COST (IN INR)
code156	Supply and delivery at site special moulded variety 25mm dia PVC Bend as per IS 7834/ 1987 and fabricated as per IG124/ 1984 with ISI mark with its latest amendments. (Vol-05, WS & SW SR 2023-24 item no 10.11.1 Page No. 118)	Each	135	
code157	Supply and delivery at site special moulded variety 32mm dia PVC Bend as per IS 7834/ 1987 and fabricated as per IG124/ 1984 with ISI mark with its latest amendments. (Vol-05, WS & SW SR 2023-24 item no 10.11.2 Page No. 118)	Each	20	
code158	Supplying and Fixing of 25 mm dia class A GI pipe bracket up to 2 mtrs long bent at suitable angle and fixing to this bracket 1x40/ 2x40 watts fluorescent tube street light fitting of all capacities to GI or CI or rail or RCC pole/ wall using suitable clamps, bolts, and nuts and wiring using suitable capacity wires (Vol-06, PWD Ele SR. 2023-24 Part-III item no 13.1.1)	Each	2	
code159	Fixing a ceiling / Wall mounting fan of all capacities and all types to the existing S hook with fan regulator to the existing board together with supplying and fixing 5A ceiling rose, necessary length of 23 / 0.0076 inch PVC insulated twin twisted copper wire and wiring. (Vol-06, PWD Ele SR. 2023-24 Part- III item no 13.10)	Each	10	

ITEM CODE	DESCRIPTION	UNIT	QUANTITY	RATE EXCLUDING GST COST (IN INR)
code160	Fixing all types and all capacities of 1x4/ 2x2 LED Light fittings indoor on the wall/ ceiling/ rafters/ girders with necessary supporting frame, using 2310.0076 twin twisted PVC insulated wires, required Nos of round blocks and clamps. (Vol-06, PWD Ele SR. 2023-24 Part- III item no 13.19)	Each	5	
code161	Fixing halogen/ metal halide/ SVL/ IL/ LED floodlight fitting over existing pole/ wall ceiling including clamps, bolts, nuts and wiring using suitable capacity wires. (Vol-06, PWD Ele SR. 2023-24 Part- III item no 13.5)	Each	24	

ITEM CODE	DESCRIPTION	UNIT	QUANTITY	RATE EXCLUDING GST COST (IN INR)
code162	<p>ESMP implementation cost - a) Provision of safety gears (helmets, safety boots, gloves, Vest/uniform, safety harness, noise plugs, first aid kits etc.) for construction workers, Providing fire safety and protection equipment (Fire Extinguisher and Water and Sand bucket) at construction site to mitigate any fire related accident during construction period and Providing Safety barricading with reflector and flood lights at site to ensure safety during night in the construction site; b) Providing basic essential for construction workers at site - toilets, lockers, change room , bathrooms with good water and light facility; Precast specitic tank (to be emptied regularly) for waste water storage, Labour camp with safe drinking water, light and satefy arrangement to be set up onsite (if labour camp is set up onsite); temporary storage of materials with proper lighting facility, transportation facility for commutation of workers if the site is isolated; c) Monitoring cost by hiring the services of environment expert and Health & safety speacialist on periodic basis to ensure implementation of ESMP as per the approved plan; and d) Undertake occupational health hazard and safety training session for all level of workers. provide environmental safety measure as per Environment, social and safety management plan by undertaking baseline data collection - Air quality (for SPM and PPM) , Water quality of borewell or piped supply which ever is applicable, Noise level during peak construction activity (In lines with EPA Act) to be tested and documented as per the guidance of Enviroment Expert; Pest control - installation of nets and application of approved safe chemical through spray if essential; Construction and demolishing waste disposal - collection, storage, transportation to designated site as per C&D Waste Management Rules (add Spill tray to handle in transportation vehicles); and provide green Net all around the construction site and includes contingency charges. The payement will be made as per approved ESMP submitted by the contractor as per the item breakup, mentioned in RfB.</p>	LS	1	

Total in figures	
Total in words	
	<p>Note:</p> <p>(a) Items without an entered rate or price will not be compensated by the Employer upon execution; such items are considered included under other rates and prices specified in the Bill of Quantities (refer to ITB Clause 14.2 and GCC Clause 45.4).</p> <p>(b) Unit rates and prices should be quoted by the bidder in Indian Rupees (refer to ITB Clause 14.1 and ITB Clause 15.1).</p> <p>(c) The financial proposal submitted by the bidders must exclude GST.</p> <p>(d) The Financial Evaluation of the proposal will consider the GST charges by adding them to the evaluated cost.</p> <p>(e) By submitting the financial proposal via the e-portal, I hereby declare by undertaking to the conditions given in Letter of Bid - Financial Part, a. Bid Validity Period: Our Bid shall remain valid for the duration specified in BDS 18.1 (or as amended, if applicable) from the date set for the Bid submission deadline in BDS 22.1 (or as amended, if applicable), and it shall remain binding and open for acceptance within that period. b. Total Bid Price: The total bid price, excluding any offered discounts, is as stated above. c. Discounts : We are in acceptance to collect the discount details from the Successful Bidder post issue of LoI. and d. Details of Gratuities, commission or fee: We accept are aware and in acceptance to be collect the details of any gratuities, commissioner or fee paid with respect to the Bidding process or execution of the Contract from the successful bidder post issue of LoI.</p>

Section V - Eligible Countries

Eligibility for the Provision of Goods, Works and Non-consulting Services in Bank-Financed Procurement

In reference to ITB 4.8, and 5.1, for the information of the Bidders, at the present time firms, goods and services from the following countries are excluded from this Bidding process:

Under ITB 4.8(a) and 5.1 : *None*

Under ITB 4.8(b) and 5.1 : *None*

[Note: as and when some country/ countries become ineligible insert the list of such countries following approval by the Bank to apply the restriction]

Section VI - Fraud and Corruption

(Section VI shall not be modified)

1. Purpose

1.1 The Bank's Anti-Corruption Guidelines and this annex apply with respect to procurement under Bank Investment Project Financing operations.

2. Requirements

2.1 The Bank requires that Borrowers (including beneficiaries of Bank financing); bidders, (applicants/proposers), consultants, contractors and suppliers; any sub-contractors, sub-consultants, service providers or suppliers; any agents (whether declared or not); and any of their personnel, observe the highest standard of ethics during the procurement process, selection and contract execution of Bank-financed contracts, and refrain from Fraud and Corruption.

2.2 To this end, the Bank:

- a. Defines, for the purposes of this provision, the terms set forth below as follows:
 - i. "corrupt practice" is the offering, giving, receiving, or soliciting, directly or indirectly, of anything of value to influence improperly the actions of another party;
 - ii. "fraudulent practice" is any act or omission, including misrepresentation, that knowingly or recklessly misleads, or attempts to mislead, a party to obtain financial or other benefit or to avoid an obligation;
 - iii. "collusive practice" is an arrangement between two or more parties designed to achieve an improper purpose, including to influence improperly the actions of another party;
 - iv. "coercive practice" is impairing or harming, or threatening to impair or harm, directly or indirectly, any party or the property of the party to influence improperly the actions of a party;
 - v. "obstructive practice" is:
 - (a) deliberately destroying, falsifying, altering, or concealing of evidence material to the investigation or making false statements to investigators in order to materially impede a Bank investigation into allegations of a corrupt, fraudulent, coercive, or collusive practice; and/or threatening, harassing, or intimidating any party to prevent it from disclosing its knowledge of matters relevant to the investigation or from pursuing the investigation; or
 - (b) acts intended to materially impede the exercise of the Bank's inspection and audit rights provided for under paragraph 2.2 e. below.
- b. Rejects a proposal for award if the Bank determines that the firm or individual recommended for award, any of its personnel, or its agents, or its sub-consultants, sub-contractors, service providers, suppliers and/ or their employees, has, directly or indirectly, engaged in corrupt, fraudulent, collusive, coercive, or obstructive practices in competing for the contract in question;

-
- c. In addition to the legal remedies set out in the relevant Legal Agreement, may take other appropriate actions, including declaring miss procurement, if the Bank determines at any time that representatives of the Borrower or of a recipient of any part of the proceeds of the loan engaged in corrupt, fraudulent, collusive, coercive, or obstructive practices during the procurement process, selection and/or execution of the contract in question, without the Borrower having taken timely and appropriate action satisfactory to the Bank to address such practices when they occur, including by failing to inform the Bank in a timely manner at the time they knew of the practices;
- d. Pursuant to the Bank's Anti- Corruption Guidelines and in accordance with the Bank's prevailing sanctions policies and procedures, may sanction a firm or individual, either indefinitely or for a stated period of time, including by publicly declaring such firm or individual ineligible (i) to be awarded or otherwise benefit from a Bank-financed contract, financially or in any other manner;²¹ (ii) to be a nominated²² sub-contractor, consultant, manufacturer or supplier, or service provider of an otherwise eligible firm being awarded a Bank-financed contract; and (iii) to receive the proceeds of any loan made by the Bank or otherwise to participate further in the preparation or implementation of any Bank-financed project;
- e. Requires that a clause be included in bidding/request for proposals documents and in contracts financed by a Bank loan, requiring (i) bidders (applicants/proposers), consultants, contractors, and suppliers, and their sub-contractors, sub-consultants, service providers, suppliers, agents personnel, permit the Bank to inspect²³ all accounts, records and other documents relating to the procurement process, selection and/or contract execution, and to have them audited by auditors appointed by the Bank.

²¹ For the avoidance of doubt, a sanctioned party's ineligibility to be awarded a contract shall include, without limitation, (i) applying for pre-qualification, expressing interest in a consultancy, and bidding, either directly or as a nominated sub-contractor, nominated consultant, nominated manufacturer or supplier, or nominated service provider, in respect of such contract, and (ii) entering into an addendum or amendment introducing a material modification to any existing contract.

²² A nominated sub-contractor, nominated consultant, nominated manufacturer or supplier, or nominated service provider (different names are used depending on the particular bidding document) is one which has been: (i) included by the bidder in its pre-qualification application or bid because it brings specific and critical experience and know-how that allow the bidder to meet the qualification requirements for the particular bid; or (ii) appointed by the Borrower.

²³ Inspections in this context usually are investigative (i.e., forensic) in nature. They involve fact-finding activities undertaken by the Bank or persons appointed by the Bank to address specific matters related to investigations/audits, such as evaluating the veracity of an allegation of possible Fraud and Corruption, through the appropriate mechanisms. Such activity includes but is not limited to: accessing and examining a firm's or individual's financial records and information, and making copies thereof as relevant; accessing and examining any other documents, data and information (whether in hard copy or electronic format) deemed relevant for the investigation/audit, and making copies thereof as relevant; interviewing staff and other relevant individuals; performing physical inspections and site visits; and obtaining third party verification of information.

PART 2 – Works' Requirements

Section VII-Works'Requirements

Specifications

All specifications of works shall be as per latest approved schedule Public Works Department (PWD), Government of Karnataka. The method of measurement of completed work for payment shall be in accordance with latest approved schedule of Public Works Department (PWD), Government of Karnataka.

Bidder may go through the following link <https://kpwd.karnataka.gov.in/> or get a copy of the approved schedules from the office of Public Works Department (PWD), Government of Karnataka. Related approved schedules with corrigendum's are listed in the PWD website as mentioned above.

The bills submitted by the contractor shall be verified by the third party appointed by RDWSD along with all essential quality test reports for each batch as per the prescribed standards with its recommendations for payment.

Environmental and Social Requirements

- 1.1. Comply with and ensure that all their Sub Contractors and major suppliers, i.e. for major supply items comply with National environmental and safety standards, consistent with applicable law and regulations in the country of implementation of the respective Contract and the fundamental conventions of the National Labor Organization and National environmental treaties and;
 - 1.2. Contractor to Construct the Works including protection of environment, and assurance of Worker and Public health and safety.
 - a. The Contractor shall construct and install the Works in accordance with the Specifications and Drawings and as per instructions of Employer, and raise any significant EHS risks with the employer at the earliest to amend the design if so required.
 - b. The Contractor shall take all reasonable steps to protect the environment on and off the Site and to avoid damage or nuisance to persons or to property of the public or others resulting from pollution, noise or other cause arising as a consequence of his methods of operation.
 - c. During continuance of the contract, the Contractor and his sub- Contractors shall abide at all times by all existing enactments on environmental protection and rules made there under, regulations, guidelines, standards, notifications and by-laws of the State or Central Government, or local authorities and other law, bye-law, regulations that may be passed or notification that may be issued in this respect in future by the State or Central Government or the local authority.
 - d. The tendered rates for the items should be inclusive of all items of works required for the safe execution of the items (viz) watering, barricading, lighting, watching, safety arrangements in the interest of traffic, safeguarding the underground services and other requirements mentioned in this Contract and the EMP, and no claim for extra payment on any score will be entertained.
 - e. Contractor's Personnel shall:
 - i. Apply good practices to protect and conserve the natural environment and to minimize unavoidable impacts;
 - ii. Ensure all consent/permit conditions for all parts of his work
- iii. Follow required national/state regulations, and World Bank Group EHS Guidelines**
- iv. Provide and maintain a healthy and safe work environment and safe systems of work;
 - v. Carry out his/her duties competently and diligently;
 - vi. Comply with this Code of Conduct and all applicable laws, regulations and other requirements, including requirements to protect the health, safety and well-being of other Contractor's Personnel and any other person; Maintain a safe working environment including by:
 - a) ensuring that workplaces, machinery, equipment and processes under each person's control are safe and without risk to health;
 - b) wearing required personal protective equipment;
 - c) Using appropriate measures relating to chemical, physical and biological substances and agents; and following applicable emergency operating procedures.

- d) report work situations that he/she believes are not safe or healthy and remove himself/herself from a work situation which he/she reasonably believes presents an imminent and serious danger to his/her life or health;
- e) protect the health and safety of local communities and users, with particular concern for those who are disabled, elderly, or otherwise vulnerable;
- f) Ensure that project staff behaves responsibly to environment in particular, not dumping waste/polluting water, air, land, or creating water-logging, etc.
- g) Ensure safe, livable, and functional labour camps if any, which do not result in Pollution or H&S impacts.
- h) Minimize the risk of communicable diseases and to mitigate the effects of communicable diseases associated with the execution of the Works.

1.3. Safety

Provide fencing of all work areas, adequate & appropriate lighting, guarding and watching of the works until completion, and provide any Temporary Works (including roadways, footways, guards and fences) which may be necessary for safe access and safety of workers and communities, during the execution of the Works, for the use and protection of the public and of owners and occupiers of adjacent land

This article defines the Contractor's responsibility with regard to providing for the safety of the public during constructions.

The Contractor shall:

- a. comply with all applicable safety regulations,
- b. take care for the safety of all persons entitled to be on the Site,
- c. Use reasonable efforts to keep the Site and Works clear of unnecessary obstruction so as to avoid danger to all persons including workers, communities, road users and any others.

Barricading:

The Contractor shall furnish, erect and maintain such strong fences, Iron barricades, with reflectors and Reflective Warning signs at appropriate locations identified by OHS in charge / Safety engineer / Supervision Engineer as are necessary and/or based on EMP to give adequate warning & protection to the public & workers at that construction is under progress and of any dangerous conditions to be encountered as a result there of in accordance with any standard designs or as directed by the Employer at any and all points in the work area or associated areas.

Lighting:

Where any type of pre-construction / construction operations in progress or any pit is made or tools or materials are stored, and the Contractor's equipment and machinery in use is of such character as to endanger passing traffic, the Contractor shall provide such lights and signs and station such guards (with protective clothing, whistle & such support tools) as may appear necessary to prevent accidents and avoid damage or injury to passing traffic or people. This applies to both day and night.

Safeguarding Pits:

When Contractors' personnel is not using the pits made for works it shall be managed safely without posing any danger to the site personnel/workers or the public – with safe temporary / permanent closure, adequate lighting, hard barricading with reflectors & signboards.

Fire Trench/Cattle proof trench for prevent spread of fire in eco sensitive Zone:

The Contractor shall be responsible for the construction of fire protection trenches or fire ditches along the boundary of the proposed site. This preventive measure is designed to mitigate the risk of accidental fires during construction activities from spreading into the adjacent forest area. The fire protection trenches shall be created by excavating long, continuous drains and clearing surface fuels, such as dry leaves, grasses, and wood. (earthen trench Dimension is 1.5 mt top width * 75 cm Bottom width * 1 mt depth)

Flag men:

During utility shifting, use of heavy equipment, laying of pipelines, and other similar works; additional flag men (with protective clothing, whistle & such support tools to warn, and to ensure safety as required) are to be provided to warn the workers and community of dangers. Respective agencies who are owners of each utility shall be informed before any work or shifting or repairs and required permits shall be arranged prior to activity initiation.

Hazard Identification & Site Monitoring:

Every morning, before work initiation, Contractors Environmental Health and Safety personnel with Engineer In charge shall visit all sites where works will take place that day and identify possible hazards and take appropriate measures arrange additional guards/flag men for possible work conditions and suggest full safeguards provision as appropriate for the work. Work permit system shall be followed for all works which have higher degree of hazards including work at heights, pits/enclosed spaces, works with sharps, possible electric hazards etc. Toolbox talks shall guide the workers on hazards and OHS, and workers at each site with experience on similar works shall be asked to provide hazard briefing to all workers / support personnel before initiating works at any site.

Safe Storage of Equipment & Material:

No material or equipment shall be stored where it will interfere with the free and safe passage of the people and traffic. At the end of each day's work when construction operations are suspended for any reasons, the Contractor shall remove all equipment, close all pits in a safe manner and other obstructions.

Safety of Slopes:

During works, the Contractor shall ensure that the cuts are safe and supported appropriately to prevent side slippage; and materials are not piled or retained in the vicinity of the pits / channels or work areas. Adequate warnings shall be provided to the community & workers at appropriate distances to prevent any imminent danger.

Considerations for Leachate & Wastes

All wastes existing in the work area and nearby reasonable distance (as required for safe work on a case to case basis) shall be removed by the Local Body before start of any activity under this Contract. All precautions are to be taken by the contractor to ensure that there is no

Fire or any other incidents including due to Pests / Reptiles etc. in the work area or material storage / associated areas.

All possible hazards due to nature of work, wastes or leachates (slippage & fall, fall from heights, collision, fire and explosion (due to batteries etc), sharps, electric hazards, work tool, heavy equipment's on site/nearby, works in leachate, drains, pests (rats, molds, insects & flies, reptiles etc) works during rains/floods, including all high energy hazards) shall be identified before start of works and appropriate precautionary measures followed so that these do not affect the health & safety of any person in the work site or associated areas. No person shall during any instance engage in working All works men shall use appropriate PPEs considering leachate, wastes, air pollution due to dust and odor, wastes on land/soil, possibility of explorable materials/wastes that may be encountered at / near to the sites which were used for storage / recycling of wastes etc.

Immediate hospital care as required shall be provided to the victims (workers / others) in case of any incidents. Immediately to the incidents works shall be stopped & resumed only after correcting the root causes. All incidents shall be recorded in the Incident register on site & reported to the PMU. Contractor shall cooperate with the Root Cause Analysis & implement the Corrective Action Plan suggested by the Engineer in Charge / PMU.

1.4. Contractor shall meet all expenses for arranging appropriate safety measures at work sites during all times.

Full Cost / coverage for the work involved in carrying out the precautionary and safety measure above specified safety and pollution management measures shall be considered as included in the prices paid for the various contract items of work and no additional allowance will be made there for.

Electric Risk

Motors, gearing, transmission, electric wiring and other dangerous parts of hosting appliances should be provided with such means will reduce to the minimum the risk of accidental descent of the load. Adequate precautions should be taken to reduce the minimum the risk of any part of a suspended load becoming accidentally displaced. When workers employed on electrical installations which are already energized insulting mats, wearing PPEs such as gloves, sleeves and, boots as may be necessary, should be provided. The workers should not wear any rings, watches and carry keys or other materials which are the good conductors of electricity.

Traffic Regulations, Other Regulations, Specifications Etc., (Necessary provisions/ modifications shall be carried out by the Employer as per the project requirements)

- (a) Tippers, trucks, water Lorries to which when not in actual use shall be drawn clear off the road, the safety to the public all precautionary measures shall be taken by way of lighting with bright red light and warning boards.
The Contractor shall maintain watchman on the works and control and regulate traffic. Notice boards shall be placed in suitable locations Warning notices shall be placed at the points in the neighborhood of the work where other roads join and across the road and at such other places and points as may be directed to enable the motorists cyclists or other vehicular traffic, avoid the obstructed road by taking alternative routes. Extra payment will not be made for any such incidental items.
- (b) Penalty for not arranging traffic regulations (if required for material transport or works):

If the Contractor fails to make arrangements for traffic regulations as described in condition (a) a penalty of Rs 500- day will be imposed on the Contractor.

Safety Measures on Display:

The safety provisions & awareness boards on emergency response measures, contact details for emergency support providers, the Engineer In charge & the Contractor should be brought to the notice of all concerned by display on a notice boards at a prominent place at work spots in the form and language understandable by the workers & the Public. The person responsible for compliance of the safety code shall be named therein by the Contractor. All warning boards shall be visible from a distance during day & night. Suitable lettering / reflective tapes shall be used for visibility & work areas shall be well lit & boards visible from appropriate distance of at least 50m (or as determined on a case to case basis by Engineer) from the start and end of work site.

Notwithstanding the provisions of this agreement, all applicable provisions of all National/ State Regulations including Environmental Protection Act. Building & Other Construction Workers Act, SWM Rules 2016 and other waste rules, The Prohibition of Employment as Manual Scavengers and their Rehabilitation Act, 2013 and the Disaster management Act, and all other applicable regulations shall be followed.

1.5. Display of provisions from labour laws

As per the Labour welfare laws, provisions should be brought to the notice of all concerned by display of minimum wages, equal wages, hours of work, rest, leave including helpline number for grievances and other information at a prominent place of work spots. the Contractor shall be responsible for compliance with labour laws.

1.6. Accidents

It shall be the Contractor's sole responsibility to protect the public and his employees against accident from any cause and he shall indemnify the Employer against any claims for damages for injury to person or property, resulting from any such accidents, and shall, where the provisions of the Workmen's Compensation Act apply, take steps to property insure against any claims there under.

The Contractor shall take out the insurance against any accidents at work site as mentioned above and as applicable by all National/State Laws before the commencement of the work and produce the insurance policy before the payment of first part bill.

Immediate to or at the maximum within 24 hours of the occurrence of an accident due to a work / activity associated with the project, that results in the death or which is so serious as in all probability to result in the death or disability of workman employed by the Contractor, or any community member / anyone else, he shall intimate in writing to the Employer the fact of such accident. The Contractor shall indemnify the Employer against all loss or damage sustained by it resulting directly or indirectly from his failure to give intimation in the manner aforesaid including the penalties of or fines if any payable by the Employer as a consequence of its failure to give notice under the Workmen's Compensation Act or otherwise conform to the provisions of the said Act in regard to such accident. Immediate to an accident (Indicative/severe/serious), appropriate steps shall be taken to remove the

causative dangerous work conditions at the earliest as guided by the Engineer in charge , and immediately the Contractor shall arrange the best available emergency and subsequent medical care to the victim.

No workers or personnel shall be allowed to enter any part of a sewer or underground or deep drains or such areas, even as part of utility shifting or cleaning or related works. Such works shall be done by machines. All provisions of respective regulations shall be fully followed.

1.7.Scaffoldings

Suitable safe scaffolds should be provided for workmen for all works that cannot safely be done from the ground, or from solid construction except such short period work as can be done safely from ladder. When a ladder is used an extra mazdoor (worker) shall be engaged for holding the ladder and if the ladder issued for carrying materials as well, suitable footholds and hand holds shall be provided on the ladder and the ladder shall be given an inclination not steeper than $\frac{1}{4}$ to 1 ($\frac{1}{4}$ horizontal and 1 vertical) Scaffolding or staging more than 3.6m (12 feet) above the ground or floor, swung or suspended from an overhead support or erected with stationary support shall have guard rail properly attached, or bolted, braced and otherwise secured at least 90 cm (3 feet) high above the floor or platform of such scaffolding or staging and extending along the entire length of the outside and ends thereof with only such opening as may be necessary for the delivery of materials. Safe means of access shall be provided to all working platforms and other working places.

Every ladder shall be securely fixed. No portable single ladder shall be over 9 m (30 feet) in length while the width between side rails in rung ladder shall in no case be less than 28 cm ($11\frac{1}{2}$ "") for ladder up to and including 3 cm (10 feet) in length. For longer ladder this width should be increased at least $\frac{1}{4}$ " for each exceed 30 cm (12"). Adequate precautions shall be taken to prevent danger from electrical equipment. No materials on any of the sites of work shall be so stacked or placed as to cause danger or inconvenience to any person or the public. The Contractor shall provide all necessary fencing, strong nets to contain falls from height and lights to protect the public from accident and shall be bound to bear the expenses of defense of every suit, action or other proceedings at law that may be brought by any person for injury sustained owing to neglect of the above precautions and to pay any damages and cost which may be awarded in any such suit, action or proceedings to any such person or which may with the consent of the Contractor, be paid to compromise and claim by any such person.

Working platforms and gangways should be so constructed that they should not sag unduly or unequally, and if the height of the platform or the gangway or the stairway is more than 3.6 m (12 feet) above the ground level or floor level, they should be so closely boarded, should have adequate width and should as suitable fastened. Safe means of access shall be provided to all working platforms and other working places.

Every opening in the floor of a building or in a working platform should be provided with suitable means to prevent the fall of persons or materials by providing suitable fencing, safe top cover or railing whose minimum height shall be 90 cm (3 feet).

1.8.Responsibility for Damage claims

The Contractor shall indemnify and save from harm the Employer , its officer and employees from all suits actions or claims of any character brought because of any injuries

or damages received or sustained by any person, persons or property on account of the operations of the said Contractor or his sub-Contractors, workers of an account or in consequence of any neglect in safeguarding the work, or through use of unacceptable materials in constructing the work or because of any claims or accounts recovered for any infringement of patent, trade mark or copy right, or from any claims or amounts arising or recovered under the Workmen's Compensation Act, or any other law, ordinance, order or decree; and so much of the money due to the Contractor under and by virtue of his contract as shall be considered necessary by the Engineer in charge for such purposes may be retained for the use of the Employer.

The Employer shall not be liable to the Contractor for damages or delays resulting from work by third parties or by injunctions or other restraining orders obtained by the third parties.

1.9. Protection and Restoration of Property

If government, corporate or private property interferes with the work the Contractor shall notify in writing the owners of such property advising them of the nature of the interference and shall arrange with them for the disposition of such property. The Contractor shall furnish the Employer with copies of such notified and final agreements.

The Contractor shall use every precaution to prevent the damage or destruction of any property including government/public, corporate or private property including buildings, compound walls, heritage structures/features etc. He shall protect or carefully preserve or all official survey monuments, bench marks, boundary stones, etc., until the owner or an unauthorized agent as witnessed or otherwise referenced their location or relocation. The Contractor shall notify the Employer of the presence of any such surveyor property monuments as soon as they are discovered. The Contractor shall be responsible for the damage or destruction of property of any character resulting from any of his acts or defaults or from defective work or materials, and such responsibility shall not be released until the work is completed and accepted. Whenever public or private property is damaged or destroyed the Contractor shall at his own expenses restore such property to a condition similar to or equal to that existing before such damage or injury in the acceptable manner.

If he fails to do so, the Engineer in charge may, after the expiration of a period of 48 hours, after giving notice to him in writing, proceed to repair, build or otherwise restore such property as may be deemed necessary and the cost thereof shall be recovered from the Contractor.

The Contractor shall give prior information to the Police Department, if necessary, for carrying out the work during night hours. NO worker / person shall be allowed to enter the work / activity area in any intoxicated condition during workdays or holidays. No worker / person shall enter any work area/activity area during holidays / nighttime / non-work hours when work is not happening, without permission of the Engineer In charge.

1.10. Personnel Protective Equipment's:

All necessary personal safety equipment's (PPEs) as considered appropriate by the Engineer in charge should be kept available for the use of the person employed on the site and maintained in a condition suitable for immediate use, and the Contractor should take adequate steps to ensure proper use of equipment by those concerned, as in the indicative list

here; or as identified by the Engineer & Contractors Occupational health and safety (OHS) person.

- a) Workers employed on mixing asphaltic materials, cement, lime mortars shall be provided with protective foot wear, gloves, masks, protective goggles.
- b) Those engaged in white washing and mixing or stacking cement bags or any materials which are injurious to the eyes shall provide with protective goggles, masks and gloves.
- c) Those engaged in welding works shall be provided with welder's protective eye shields.
- d) Stone breakers shall be provided with protective goggles and protective clothing seated sufficiently safe intervals.
- e) The Contractor shall not employ men and women below the age of 18 years in the work. Wherever men above the age of 18 are employed on the work of lead painting the following precautions should be taken.
- f) No paint containing lead or lead products shall be used except in the form of paste of ready-made paint.
- g) Suitable face masks should be supplied for use by the workers when paint is applied in the form of spare or surface having lead dry rubbed and scraped.
- h) Overalls shall be supplied by the Contractors to the workmen and adequate facilities shall be provided to enable the working painters to wash during the cessation and work.
- i) The Contractor shall not employ women & men below the age 18 on the work of painting with products containing lead, in any form.

1.11. First Aid Provision in Site:

All sites shall have full-fledged First Aid Kits with all required medicines & tools for immediate action. First Aid Kits shall not be used for storing any other material than medicines and required tools for medical aid. Workers, Supervisors shall be appropriately educated on the availability & use of kits.

When the work is done near any place where there is risk of drowning all necessary steps taken to avoid the risk, by providing warning signs in the language worker can understand; appropriate PPEs, harnesses, buoys etc; and arrangements for prompt rescue of any person in danger and adequate provisions should be made for prompt first aid treatment of all injuries likely to be sustained during the course of the work.

1.12. Discoveries/Chance Finds

The Contractor shall notify the Client & the relevant authority of such discoveries and carry out the instructions for dealing with them. The contractor shall handover, if any artifacts, objects or anything of historical are found unexpectedly while excavating or during any works. .

Environmental and Social Management Plan (ESMP) – Indicative

Environmental & Social Management plan provides measures to minimize the anticipated impacts of the project. Before start of works, the Contractor needs to update this ESMP to a Contractors ESMP (C=ESMP) that is site & design specific

SI No	E&S issues	Mitigation Measures	Planning / Implementation Responsibility	Monitoring Responsibility
A		Planning and Pre-Construction Stage		
1	Planning for MRF			
1	Site Access Closure	<ul style="list-style-type: none"> ▪ Stop all other activities on site before commencement of any civil works. ▪ Prohibit all public access to the site, including waste pickers and scavengers vide adequate fencing/compound wall, manned security, and signage which prohibit public access completely, to avoid risk to the public. ▪ Close site fully and display appropriate signage at the site entrance to indicate that the waste dump has been closed from the operation. ▪ Provide compound wall as per contour of the ground to avoid land disturbance and movement, the fence/compound wall shall ▪ Perform grading shall be performed where necessary to provide a neat appearance 	RWS, Local Body	PIU
3	Absence / Delay in Permissions for Developing the MRF and associated works as per National regulations	<ul style="list-style-type: none"> ▪ Obtain required permissions for undertaking MRF and assessments conducted for undertaking these as per existing Laws, Regulations; including for associated infrastructure, DG Sets, Consent to Establish; and other licenses including those as per Labor Laws, before the start of works on site 	Contractor, ULB, RWS, Local Body	PIU
4	Dust impacts due to Site Preparation (<i>Air Pollution</i>) and <i>Visual Blight due to excavation</i>	<ul style="list-style-type: none"> ▪ Provide temporary high screen, buffers around the site before the start of work to curtail dust emissions ▪ Arrange a green belt as early as possible on the area of the site with no / less dump. (preferably fast-growing thick canopies of indigenous trees, shrubs in layers) 	Contractor	PIU
5	Material sourcing, transport, and stacking of construction materials (<i>Occupational Health and Safety issues and Air noise pollution</i>)	<ul style="list-style-type: none"> ▪ Provide prior intimation to neighbors on proposed construction activities, timings, emergency contacts, grievance mechanism to register grievances, if any ▪ Provide prior intimation to nearby Health Centre on work activities need for medical support, emergency support needs, type of laborers on-site and labor camp if any ▪ Source materials only from approved quarries ▪ Transport material only in closed trucks with PUC certificates, with water sprinkling if required to curtail dust emissions. ▪ Ensure driver has valid license and follow speed regulations ▪ Ensure materials transported preferably through well-surfaced roads. If 	Contractor	PIU

SI No	E&S issues	Mitigation Measures	Planning / Implementation Responsibility	Monitoring Responsibility
		<p>road it kuchcha, water sprinkling shall be done to prevent dust emission before and after truck passes</p> <ul style="list-style-type: none"> ▪ Ensure material transportation and unloading activities should not result in noise disturbance to locals and should be during day time ▪ Ensure materials are properly stored/stacked following good housekeeping practices (labeling, properly arranged); in covered sheds to prevent loss of strength and loss of material. Material storage shall not result in any harm to workers or visitors. ▪ Provide vehicle wheel wash area on site ▪ Provide workers to be provided with Personnel Protection Equipment (PPE) including safety boots, jackets, ear muffs, gloves. ▪ Proper rest area on site shall be provided with water, first aid, toilets 		
6	The layout of Labour camp (<i>Impacts on Air, Water, Land, Fauna/Flora, Socio-economic</i>)	<ul style="list-style-type: none"> ▪ In case a labour camp is required, the Labour camp layout, design and material/fire safety plan shall be approved by site engineer before start of construction of the camp ▪ Inform nearby health center about the labor camp and have a tie up for any treatment/ checkup/tests ▪ Ensure safety of materials used for the camp (from corrosion, fire/flood/other manmade and natural disasters) ▪ Ensure camp is not set up on waste dumping yard or similar areas or in an area prone to Hazards ▪ Ensure camp is located at higher plinth levels to prevent water intrusion ▪ Ensure rooms shall be of appropriate sizes with adequate ventilation and livable temperature/other conditions and facilities like proper beds, storage areas, common kitchen when the wood is not used as a fuel (better to use LPG) ▪ Provide proper facilities at the camp including food and common entertainment facilities, crèche, toilets with proper septic tanks, washing area, wastewater, and waste collection/management systems, etc ▪ Maintain camp in good clean hygienic conditions and shall have outdoor seating areas, greenery, security 	Contractor	Site engineer of PIU, RWS, Labour Commissioner, PCB
7	Nearness/disturbance to sensitive areas such as forests, wildlife habitations, etc. especially in case of providing support	<ul style="list-style-type: none"> ▪ Ensure site selection for support facilities or activities based on the screening checklist and the master plan of the region, to avoid sensitive areas. Follow mitigation hierarchy – Avoid, Minimize, Mitigate, Reduce. Obtain requisite permissions from respective authorities such as Department of Environment and Forests, Pollution Control Board, SCZMA ▪ Covered and well-marked storage area for excavated wastes and washing, 	RWS, Local Body	PIU

SI No	E&S issues	Mitigation Measures	Planning / Implementation Responsibility	Monitoring Responsibility
	facilities (<i>Impacts on Fauna / Flora</i>)	segregation of the same are to be arranged		
9	Nuisance hazards to neighboring areas	<ul style="list-style-type: none"> ▪ Ensure proper design and adequate compound wall; high screen during construction, buffer zones and thick green belt to comply with SWM Rules, 2016 and other PCB requirements ▪ In case of waste mound and site edges are sliding or unsafe; provide engineered retention walls. ▪ 	Contractor	RWS, Panchayat PIU, PCB
B	Construction / Implementation stage			
1	Impact due to the vehicular movement (<i>Air and noise environment</i>)	<ul style="list-style-type: none"> ▪ Maintain vehicles and machinery so that emission conforms to National Ambient air quality standards. ▪ Obtain Pollution Under Control Certificates for all vehicles and machinery should obtain ▪ Erect HORN PROHIBITION signpost . ▪ Rumble strips/speed breaker to be provided. 	Contractor	PIU
2	Impact due to the use of construction equipment (<i>Air and Noise</i>)	<ul style="list-style-type: none"> ▪ Mixing equipment should be well sealed and be equipped with a dust-removal device. ▪ Ensure Operators should wear dust masks, ear protection, and hard hats. ▪ Cover vehicles delivering materials to reduce spills and dust blowing off the load. ▪ Provide labor with masks / PPEs. ▪ Fence construction site that are prone to dust generation shall have fencing to arrest dust spreading into neighboring sensitive land uses ▪ Ensure strict monitoring of Noise standards at construction machines to prevent exceeding of GOI noise standards. ▪ Workers in the vicinity of strong noise to wear protectors and their working time should be limited as a safety measure. ▪ Ensure that in construction sites within 150 m of sensitive receptors and settlement areas construction to be stopped from 22:00 to 06:00 hrs. ▪ Machinery and vehicles should be maintained to keep their noise to a minimum. ▪ Construct Noise barriers at all noise-sensitive locations. 	Contractor	PIU
3	Impact during the construction activities (<i>water environment</i>)	<ul style="list-style-type: none"> ▪ Avoid construction work close to water bodies during monsoon. ▪ Site Labourcamps away from water bodies. ▪ Vehicle washing or maintenance near water bodies are to be avoided. ▪ Contaminated water from construction activities carrying soil, cement wash, etc shall not be allowed to flow out of the site. It shall be contained and treated on site. 	Contractor	PIU

SI No	E&S issues	Mitigation Measures	Planning / Implementation Responsibility	Monitoring Responsibility
		<ul style="list-style-type: none"> ▪ Contractor should not discharge construction waste water directly onto ground or to nearest drain. It shall be routed through an appropriate silt pit to trap all particles & clean water may be allowed to drain. Material in the pit may be disposed without harm to environment or people. The silt trap shall be used as fire water / drainage silt containment during O&M phase. When the solid particles settles down, the clear water can be reused for curing or any other construction purposes. When the solid particles settles down, the clear water can be reused for curing or any other construction purposes 		
7	Transportation of wastes or retrieved or other material in overloaded and open vehicles <i>(Air, Odour nuisances; spills and littering impacts on Air, Water, Land)</i>	<ul style="list-style-type: none"> ▪ Ensure all vehicles shall carry only approved load of weight as per SOP ▪ Ensure regular cleaning of roads & drains and removal of spills if any. ▪ All Transport vehicles shall be covered ▪ Ensure provisions of SWM Rules 2016 for all waste / retrieved material Transportation activities 	Contractor	PIU
9	Occupational health and safety impacts of the workers during the construction of support facilities: <ul style="list-style-type: none"> • Health impacts of exposure to a variety of harmful materials of waste-related pollutants. • Accidental spillage by moving vehicles. • Cut & Bruises during handling of materials/rejects • Allergies from pathogen and airborne dust <i>(Air environment, Health impacts)</i> 	<ul style="list-style-type: none"> ▪ Provide First Aid and other related activities at appropriate locations ▪ Prepare emergency preparedness plans and implement for all manpower working centers and its field extension centers. ▪ Prepare an Environment Health & Safety policy shall be prepared and implemented throughout the activities area. ▪ Establish a labor grievance mechanism for addressing issues, complaints and grievances of workers ▪ Provide workers with PPE such as face mask, gloves, shoes, nose masks & goggles ▪ Provide non-slippery work areas ▪ Proper training will be provided regarding the maintenance of Health ▪ Provide workers with rest areas, toilet facilities (with septic tanks), food, and water in a hygienic environment (with proper handwash). Provide clean eating areas where workers are not exposed to hazardous or noxious substances; ▪ Ensure First aid facilities are available at accessible places. More than one first aid station if the site is large ▪ Tie-up with the local hospital / Health Centre to provide an ambulance to handle emergency cases if required and for regular health checkups. Arrange daily health checkup for workers working on waste heaps ▪ Carry out routine inspections, housekeeping, and maintenance at regular intervals. ▪ Adopt measures such as deferred timings and stretch break, where necessary 	Facility operator	PIU

SI No	E&S issues	Mitigation Measures	Planning / Implementation Responsibility	Monitoring Responsibility
		<ul style="list-style-type: none"> ▪ Secure all installations from unauthorized intrusion and accident risks; ▪ Provide Health and Safety orientation training to all new workers to ensure that they are apprised of the basic site rules of work at the site, personal protective protection, and preventing injuring to fellow workers; ▪ Provide visitor orientation if visitors to the site can gain access to areas where hazardous conditions or substances may be present. Ensure also that visitor/s do not enter hazard areas if any, unescorted ▪ Ensure the visibility of workers through their use of high visibility vests when working in or walking through heavy equipment operating areas; ▪ Ensure moving equipment is outfitted with audible back -up alarms; ▪ Mark and provide signboards for hazardous areas such as energized electrical devices and lines, service rooms housing high voltage equipment, and areas for storage and disposal. Signage shall follow international standards and be well known to, and easily understood by workers, visitors, and the general public as appropriate; ▪ Disallow worker exposure to noise level greater than 85 dBA for more than 8 hours a day without hearing protection ▪ Register all workers shall be registered as per prevalent labor laws (including a workforce of subcontractors) and provided insurance cover ▪ Workers and their kith and kin shall be suitably informed about the registration, other details of workers, and insurance details and provide contact details of contractors person/insurance agent ▪ Inform workers on possible dangers while using heavy machinery like JCB, cranes, etc and prevent going near operating / movement areas. Flagmen should be arranged on-site with a whistle. ▪ inform communities to prevent children and others from going near operating / movement areas While using heavy machinery like JCB, cranes, etc., ▪ Flagmen shall be arranged if work is near schools, hospitals, major roads, and traffic control is required with the support of police. ▪ Implement a work permit system for all works related to working at heights (typically when working over 2m and above) and for hot jobs; · ▪ All works related to working at heights will be undertaken only during the daytime when sufficient sunlight is available; ▪ Deploy temporary fall protection measures in scaffolds and out edges of elevated work surfaces, such as handrails and toe boards to prevent materials from being dislodged will be done; ▪ Ensure critical controls for all High Energy Hazards & Other Hazards shall be in place 		

SI No	E&S issues	Mitigation Measures			Planning / Implementation Responsibility	Monitoring Responsibility
		Welding activities and Concreting activities	Visual Impacts can occur during construction phase	a) The project area/Site area to be enclosed and to avoid public access b) Display board containing information like project details, name and mobile number of Engineer at RWS and name and mobile number of Contractors for public awareness that construction is on-going in the facility		
		Operation of DG sets during Construction activities	Release of air pollutants such as NOx, CO and PM10	Type approved DG sets with adequate stack height shall be provided. as per permit conditions.		
		OHS during construction - Demolition, Civil Works - Masonry, welding activities..etc.-	<ul style="list-style-type: none"> •Working at height without proper PPE •Handling of cement, paint and other chemicals •Accidental spillage by moving vehicles. •Cut & Bruises during handling of materials/rejects •Unauthorized entry to site premises •Working without permit system •Use of faulty welding machine grinding machine etc. •Smoking in site premises 	<ul style="list-style-type: none"> · A work permit system will be implemented for all works related to all high energy hazards including work at heights, work in enclosed spaces, work in areas frequented by reptiles / pests, hot jobs, and other activities where leachate, wastes etc. may be encountered · All noisy activities shall be restricted during daytime between 9 AM to 6 PM. Noise enclosures shall be arranged in case of any activity that produces more than permissible noise levels · All works related to working at heights will be undertaken only during the daytime when sufficient sunlight is available; · Use of temporary fall protection 		

SI No	E&S issues	Mitigation Measures		Planning / Implementation Responsibility	Monitoring Responsibility	
			<ul style="list-style-type: none"> •Absence of first aid box •Over speeding of trucks or any vehicles or not following traffic rules. •Non informing or damaging any artefacts ,objects or anything of historical are found unexpectedly while excavating •Fire incidents during welding •Accidents during construction 	<p>measures in scaffolds and out edges of elevated work surfaces, such as handrails and toe boards to prevent materials from being dislodged will be done;</p> <ul style="list-style-type: none"> · To manage pests if encountered during works, use approved insecticides and suitable snake repellents in the facility, and avoid any insecticides containing materials banned as per WHO, and / or National / State regulations. However, no material that would harm the environment or people shall be used. The most appropriate mechanism would be to follow integrated pest management, guided by experts in the field · Not to overload ladders · Not to overreach on ladders or stepladders · Not to rest a ladder against weak upper surfaces, for example glazing or plastic gutters · Do not use ladders or stepladders for strenuous or heavy tasks, only use them for light work of short duration (a maximum of 30 minutes at a time). · To Provide, protective clothing, respirator when handling cement or dry materials 		

SI No	E&S issues	Mitigation Measures		Planning / Implementation Responsibility	Monitoring Responsibility
			<ul style="list-style-type: none"> · No over loading to be allowed in vehicles, the primary reason for spillage is over loading .The vehicle should be properly washed and serviced at regular intervals · Use cut resistant gloves while handling sharp edged materials · Site access to be restricted (site entry and exit to be guarded) · Material storage to be away from access and it should be clearly marked and barricaded · Open pits or floor opening to be put up with barricade or safe tops · Tool box and permit system to be made mandatory in day today operation · Welding machines to be provided with flash back arrester and grinding machines to be provided with guards · No smoking signage to be displayed at site · All sites shall have full-fledged First Aid Kits with all required medicines & tools for immediate action. · First Aid Kits shall not be used for storing any other material than medicines and required tools for medical aid. Workers, Supervisors shall be appropriately educated on 		

SI No	E&S issues	Mitigation Measures		Planning / Implementation Responsibility	Monitoring Responsibility
			<p>the availability & use of kits.</p> <ul style="list-style-type: none"> · All tippers/heavy vehicles to be fitted with speed governors and drivers should have valid licences and trainings <p>All work areas & signages shall be well lit at all times</p>		
12	Pest / Vermin Control (Odor, flies, rodent / other pest menaces)	<ul style="list-style-type: none"> ▪ Regular cleaning and approved pest control measures to be adopted ▪ Bio pesticides / biological control or Integrated Pest Management also using locally effective techniques shall be followed. ▪ Banned pesticides/insecticides shall not be used. ▪ Workers shall be made aware of storage and use of pest control measures and PPEs to be used 		Contractor	PIU

Institutional Responsibility

E&S aspects of the Proposed MRF Construction & Operation will be ensured as per ESMF. The Contractor and Facility Operator will deploy E&S Monitoring Supervisor of appropriate qualification for monitoring, training & reporting. Incidents if any will be reported by the Project in line with WB ESIRT. Compliance with ESMF in line with National Regulations and WB ESF will be supervised by Panchayat, RWS and E&S officers of the RWS, and PIU.

Payment for ES Requirements

A lumpsum provision has been made for handling the ESMF activities. The contractor needs to submit his quote for ESMF component.

*Indicative List of ESMF component.

Sl. No.	Details	Percentage breakup of 1% of the quoted rate
1	Safety gears for workers	10%
a	Helmets	
b	Safety boots	
c	Gloves	
d	Weilding protection gears for eyes and body	
e	Uniform	
f	Safety Vests/uniform	
g	Safety harness	
h	Noise plugs	
2	Fire protection equipment	5%
a	Extinguisher	
b	Water and sand buckets	
3	Safety of site	10%
a	Safety barricading using strips and poles with reflectors	
b	Flood lights for site during night to ensure safety and visibility during night	
4	Basic essentials for workers	5%
a	Toilets, Change room and bath rooms with good water facility and lights	
b	Precast septic tank (to be emptied regularly) for waste water storage.	
c	Stay beds, kitchen with portable water facility, washing facility for vessels and clothes, good lighting and safety arrangements, if labour camps are setup on site. (onsite workers)	
d	Temporary storage room with lights	

e	Transportation facility for commutation of workers as these sites are isolated (offsite workers)	
f	Lockers for Workers	
5	Monitoring cost	20%
a	Per day charges of Environment Expert	
b	Per day charges of Health and Safety Speacialist	
c	Occupational Health Hazard and Safety training session for all level for workers	
6	Environment Safety	45%
a	Dust supression using water tanker	
b	Sign boards with project type, funding agency, implementing agency, start date and completion date, name of contractor, Grievance redresssal contact number and Project Manager, RDWSD Official contact details	
c	Pest control - installation of nets and application of approved safe chemical through spray if essential	
d	Construction and demolishing waste disposal - collection, storage, transportation to designated site as per C&D Waste Management Rules Spill tray to handle	
e	Green Net all around the site	
f	Baseline data collection - Air quality (for SPM and PPM) , Water quality of borewell or piped supply which ever is applicable, Noise level during peak construction activity (In lines with EPA Act) to be tested and documented as per the guidance of Enviroment Expert	
g	Contingency or miscelanoeous item if any to be executed during construction works can be added here	5%

Drawings

Enclosed vide Annexure 1.

PART 3 – Conditions of Contract and Contract Forms

Section VIII - General Conditions of Contract

These General Conditions of Contract (GCC), read in conjunction with the Particular Conditions of Contract(PCC) and other documents listed therein, should be a complete document expressing fairly the rights and obligations of both parties.

These General Conditions of Contract have been developed on the basis of considerable international experience in the drafting and management of contracts, bearing in mind a trend in the construction industry towards simpler, more straightforward language.

The GCC can be used for both smaller admeasurement contracts and lump sum contracts.

General Conditions of Contract

A. General

1. Definitions

Boldface type is used to identify defined terms.

- (a) The **Accepted Contract Amount** means the amount accepted in the Letter of Acceptance for the execution and completion of the Works and the remedying of any defects.
- (b) The **Activity Schedule** is a schedule of the activities comprising the construction, installation, testing, and commissioning of the Works in a lump-sum contract. It includes a lump-sum price for each activity, which is used for valuations and for assessing the effects of Variations and Compensation Events.
- (c) The **Adjudicator** is the person appointed jointly by the Employer and the Contractor to resolve disputes in the first instance, as provided for in GCC 23.
- (d) **Bank** means the financing institution **named in the PCC**.
- (e) **Bill of Quantities** means the priced and completed Bill of Quantities forming part of the Bid.
- (f) **Compensation Events** are those defined in GCC Clause 46 hereunder.
- (g) The **Completion Date** is the date of completion of the Works as certified by the Project Manager, in accordance with GCC Sub-Clause 57.1.
- (h) The **Contract** is the Contract between the Employer and the Contractor to execute, complete, and maintain the Works. It consists of the documents listed in GCC Sub-Clause 2.3 below.
- (i) The **Contractor** is the party whose Bid to carry out the Works has been accepted by the Employer.
- (j) The **Contractor's Bid** is the completed bidding document submitted by the Contractor to the Employer.
- (k) The **Contract Price** is the Accepted Contract Amount stated in the Letter of Acceptance and thereafter as adjusted in accordance with the Contract.
- (l) **Days** are calendar days; months are calendar months.
- (m) **Dayworks** are varied work inputs subject to payment on a time basis for the Contractor's employees and Equipment, in addition to payments for associated Materials and Plant.

-
- (n) A **Defect** is any part of the Works not completed in accordance with the Contract.
 - (o) The **Defects Liability Certificate** is the certificate issued by Project Manager upon correction of defects by the Contractor.
 - (p) The **Defects Liability Period** is the period **named in the PCC** pursuant to GCC Sub-Clause 38.1 and calculated from the Completion Date.
 - (q) **Drawings** means the drawings of the Works, as included in the Contract, and any additional and modified drawings issued by (or on behalf of) the Employer in accordance with the Contract, include calculations and other information provided or approved by the Project Manager for the execution of the Contract.
 - (r) The **Employer** is the party who employs the Contractor to carry out the Works, **as specified in the PCC**.
 - (s) **Equipment** is the Contractor's machinery and vehicles brought temporarily to the Site to construct the Works.
 - (t) "**In writing**" or "**written**" means hand-written, type-written, printed or electronically made, and resulting in a permanent record;
 - (u) The **Initial Contract Price** is the Contract Price listed in the Employer's Letter of Acceptance.
 - (v) The **Intended Completion Date** is the date on which it is intended that the Contractor shall complete the Works. The **Intended Completion Date** is specified in the PCC. The **Intended Completion Date** may be revised only by the Project Manager by issuing an extension of time or an acceleration order.
 - (w) **Materials** are all supplies, including consumables, used by the Contractor for incorporation in the Works.
 - (x) **Plant** is any integral part of the Works that shall have a mechanical, electrical, chemical, or biological function.
 - (y) The **Project Manager** is the person named in the PCC (or any other competent person appointed by the Employer and notified to the Contractor, to act in replacement of the Project Manager) who is responsible for supervising the execution of the Works and administering the Contract.
 - (z) **PCC** means Particular Conditions of Contract.
 - (aa) The **Site** is the area defined as such in the PCC.
 - (bb) **Site Investigation Reports** are those that were included

in the bidding document and are factual and interpretative reports about the surface and subsurface conditions at the Site.

- (cc) **Specification** means the Specification of the Works included in the Contract and any modification or addition made or approved by the Project Manager.
- (dd) The **Start Date** is **given in the PCC**. It is the latest date when the Contractor shall commence execution of the Works. It does not necessarily coincide with any of the Site Possession Dates.
- (ee) A **Subcontractor** is a person or corporate body who has a Contract with the Contractor to carry out a part of the work in the Contract, which includes work on the Site.
- (ff) **Temporary Works** are works designed, constructed, installed, and removed by the Contractor that are needed for construction or installation of the Works.
- (gg) A **Variation** is an instruction given by the Project Manager which varies the Works.
- (hh) The **Works** are what the Contract requires the Contractor to construct, install, and turn over to the Employer, as defined in the PCC.
- (ii) “**Contractor’s Personnel**” refers to all personnel whom the Contractor utilizes on the Site or other places where the Works are carried out, including the staff, labor and other employees of each Subcontractor.
- (jj) “**Key Personnel**” means the positions (if any) of the Contractor’s personnel that are stated in the Specification.
- (kk) “**ES**” means Environmental and Social (including Sexual Exploitation and Abuse (SEA), and Sexual Harassment (SH)).
- (ll) “**Sexual Exploitation and Abuse**” “**(SEA)**” means the following:

Sexual Exploitation is defined as any actual or attempted abuse of position of vulnerability, differential power or trust, for sexual purposes, including, but not limited to, profiting monetarily, socially or politically from the sexual exploitation of another;

Sexual Abuse is defined as the actual or threatened physical intrusion of a sexual nature, whether by force or under unequal or coercive conditions.

- (mm) “**Sexual Harassment**” “**(SH)**” is defined as unwelcome sexual advances, requests for sexual favors, and other

verbal or physical conduct of a sexual nature by the Contractor's Personnel with other Contractor's or Employer's Personnel; and

- (nn) “**Employer's Personnel**” refers to the Project Manager and all other staff, labor and other employees (if any) of the Project Manager and of the Employer engaged in fulfilling the Employer's obligations under the Contract; and any other personnel identified as Employer's Personnel, by a notice from the Employer or the Project Manager to the Contractor.

2. Interpretation

- 2.1 In interpreting these GCC, words indicating one gender include all genders. Words indicating the singular also include the plural and words indicating the plural also include the singular. Headings have no significance. Words have their normal meaning under the language of the Contract unless specifically defined. The Project Manager shall provide instructions clarifying queries about these GCC.
- 2.2 If sectional completion is **specified in the PCC**, references in the GCC to the Works, the Completion Date, and the Intended Completion Date apply to any Section of the Works (other than references to the Completion Date and Intended Completion Date for the whole of the Works).
- 2.3 The documents forming the Contract shall be interpreted in the following order of priority:
- (a) Agreement,
 - (b) Letter of Acceptance,
 - (c) Contractor's Bid,
 - (d) Particular Conditions of Contract,
 - (e) General Conditions of Contract, including Appendices,
 - (f) Specifications,
 - (g) Drawings,
 - (h) Bill of Quantities,¹ and
 - (i) any other document **listed in the PCC** as forming part of the Contract.

3. Language and Law

- 3.1 The language of the Contract and the law governing the Contract are **stated in the PCC**.
- 3.2 Throughout the execution of the Contract, the Contractor shall comply with the import of goods and services prohibitions in

¹ In lump-sum contracts, delete “Bill of Quantities” and replace with “Activity Schedule.”

the Employer's country when

(a) as a matter of law or official regulations, the Borrower's country prohibits commercial relations with that country; or

(b) by an act of compliance with a decision of the United Nations Security Council taken under Chapter VII of the Charter of the United Nations, the Borrower's Country prohibits any import of goods from that country or any payments to any country, person, or entity in that country.

- | | |
|---------------------------------------|--|
| 4. Project Manager's Decisions | 4.1 Except where otherwise specifically stated, the Project Manager shall decide contractual matters between the Employer and the Contractor in the role representing the Employer. |
| 5. Delegation | 5.1 Unless otherwise specified in the PCC , the Project Manager may delegate any of his duties and responsibilities to other people, except to the Adjudicator, after notifying the Contractor, and may revoke any delegation after notifying the Contractor. |
| 6. Communications | 6.1 Communications between parties that are referred to in the Conditions shall be effective only when in writing. A notice shall be effective only when it is delivered. |
| 7. Subcontracting | 7.1 The Contractor may subcontract with the approval of the Project Manager, but may not assign the Contract without the approval of the Employer in writing. Subcontracting shall not alter the Contractor's obligations. The Contractor shall require that its Subcontractors execute the Works in accordance with the Contract, including complying with the relevant ES requirements and the obligations set out in Sub-Clause 28.1. |
| 8. Other Contractors | <p>8.1 The Contractor shall cooperate and share the Site with other contractors, public authorities, utilities, and the Employer between the dates given in the Schedule of Other Contractors, as referred to in the PCC. The Contractor shall also provide facilities and services for them as described in the Schedule. The Employer may modify the Schedule of Other Contractors, and shall notify the Contractor of any such modification.</p> <p>8.2 The Contractor shall also, as stated in the Specifications or as instructed by the Project Manager, cooperate with and allow appropriate opportunities for the Employer's or any other personnel, notified to the Contractor by the Employer or Project Manager, to conduct any environmental and social assessment.</p> |

9. Personnel and Equipment

- 9.1 The Contractor shall employ the Key Personnel and use the Equipment identified in its Bid, to carry out the Works or other personnel and Equipment approved by the Project Manager. The Project Manager shall approve any proposed replacement of Key Personnel and Equipment only if their relevant qualifications or characteristics are substantially equal to or better than those proposed in the Bid.
- 9.2 The Project Manager may require the Contractor to remove (or cause to be removed) any person employed on the Site or Works, including the Key Personnel (if any), who:
- (a) persists in any misconduct or lack of care;
 - (b) carries out duties incompetently or negligently;
 - (c) fails to comply with any provision of the Contract;
 - (d) persists in any conduct which is prejudicial to safety, health, or the protection of the environment;
 - (e) based on reasonable evidence, is determined to have engaged in Fraud and Corruption during the execution of the Works;
 - (f) has been recruited from the Employer's Personnel;
 - (g) undertakes behavior which breaches the Code of Conduct for Contractor's Personnel (ES).

If appropriate, the Contractor shall then promptly appoint (or cause to be appointed) a suitable replacement with equivalent skills and experience.

Notwithstanding any requirement from the Project Manager to remove or cause to remove any person, the Contractor shall take immediate action as appropriate in response to any violation of (a) through (g) above. Such immediate action shall include removing (or causing to be removed) from the Site or other places where the Works are being carried out, any Contractor's Personnel who engages in (a), (b), (c), (d), (e) or (g) above or has been recruited as stated in (f) above."

- 9.3 The Contractor shall take all necessary safety measures to avoid the occurrence of incidents and injuries to any third party associated with the use of, if any, Equipment on public roads or other public infrastructure. The Contractor shall monitor road safety incidents and accidents to identify negative safety issues, and establish and implement necessary measures to resolve them.

9.4 Labor

- 9.4.1 *Engagement of Staff and Labor.* The Contractor shall provide and employ on the Site for the execution of the Works such skilled, semi-skilled and unskilled labor as is necessary for the proper and timely execution of the Contract. The Contractor is encouraged, to the extent practicable and reasonable, to employ staff and labor with appropriate qualifications and

-
- 10. Employer's and Contractor's Risks** 10.1 The Employer carries the risks which this Contract states are Employer's risks, and the Contractor carries the risks which this Contract states are Contractor's risks.
- 11. Employer's Risks** 11.1 From the Start Date until the Defects Liability Certificate has been issued, the following are Employer's risks:
- (a) The risk of personal injury, death, or loss of or damage to property (excluding the Works, Plant, Materials, and Equipment), which are due to
 - (i) use or occupation of the Site by the Works or for the purpose of the Works, which is the unavoidable result of the Works or
 - (ii) negligence, breach of statutory duty, or interference with any legal right by the Employer or by any person employed by or contracted to him except the Contractor.
 - (b) The risk of damage to the Works, Plant, Materials, and Equipment to the extent that it is due to a fault of the Employer or in the Employer's design, or due to war or radioactive contamination directly affecting the country where the Works are to be executed.
- 11.2 From the Completion Date until the Defects Liability Certificate has been issued, the risk of loss of or damage to the Works, Plant, and Materials is an Employer's risk except loss or damage due to
- (a) a Defect which existed on the Completion Date,
 - (b) an event occurring before the Completion Date, which was not itself an Employer's risk, or
 - (c) the activities of the Contractor on the Site after the Completion Date.
- 12. Contractor's Risks** 12.1 From the Starting Date until the Defects Liability Certificate has been issued, the risks of personal injury, death, and loss of or damage to property (including, without limitation, the Works, Plant, Materials, and Equipment) which are not Employer's risks are Contractor's risks.
- 13. Insurance** 13.1 The Contractor shall provide, in the joint names of the Employer and the Contractor, insurance cover from the Start Date to the end of the Defects Liability Period, in the amounts and deductibles **stated in the PCC** for the following events which are due to the Contractor's risks:
- (a) loss of or damage to the Works, Plant, and Materials;
 - (b) loss of or damage to Equipment;

(c) loss of or damage to property (except the Works, Plant, Materials, and Equipment) in connection with the Contract; and

(d) personal injury or death.

13.2 Policies and certificates for insurance shall be delivered by the Contractor to the Project Manager for the Project Manager's approval before the Start Date. All such insurance shall provide for compensation to be payable in the types and proportions of currencies required to rectify the loss or damage incurred.

13.3 If the Contractor does not provide any of the policies and certificates required, the Employer may effect the insurance which the Contractor should have provided and recover the premiums the Employer has paid from payments otherwise due to the Contractor or, if no payment is due, the payment of the premiums shall be a debt due.

13.4 Alterations to the terms of an insurance shall not be made without the approval of the Project Manager.

13.5 Both parties shall comply with any conditions of the insurance policies.

14. Site Data

14.1 The Contractor shall be deemed to have examined any Site Data **referred to in the PCC**, supplemented by any information available to the Contractor.

15. Contractor to Construct the Works

15.1 The Contractor shall construct and install the Works in accordance with the Specifications and Drawings.

15.2 If the Contract specifies that the Contractor shall design any part of the permanent Works, the Contractor shall take into account the Employer's requirements which may include, if stated in the Specifications:

(a) designing structural elements of the Works taking into account climate change considerations;

(b) applying the concept of universal access (the concept of universal access means unimpeded access for people of all ages and abilities in different situations and under various circumstances; and

(c) considering the incremental risks of the public's potential exposure to operational accidents or natural hazards, including extreme weather events.

16. The Works to Be Completed by the Intended Completion

16.1 The Contractor may commence execution of the Works on the Start Date and shall carry out the Works in accordance with the Program submitted by the Contractor, as updated with the approval of the Project Manager, and complete them by the

Date	Intended Completion Date.
	<p>16.2 The Contractor shall not carry out mobilization to the Site unless the Project Manager gives approval, an approval that shall not be unreasonably delayed, to the measures the Contractor proposes to address environmental and social risks and impacts, which at a minimum shall include applying the Management Strategies and Implementation Plans (MSIPs) and Code of Conduct for Contractor's Personnel submitted as part of the Bid and agreed as part of the Contract.</p> <p>The Contractor shall submit, to the Project Manager for its approval any additional MSIPs as are necessary to manage the ES risks and impacts of ongoing Works. These MSIPs collectively comprise the Contractor's Environmental and Social Management Plan (C-ESMP). The Contractor shall review the C-ESMP, periodically (but not less than every six (6) months), and update it as required to ensure that it contains measures appropriate to the Works. The updated C-ESMP shall be submitted to the Project Manager for its approval.</p>
17. Approval by the Project Manager	<p>17.1 The Contractor shall submit Specifications and Drawings showing the proposed Temporary Works to the Project Manager, for his approval.</p> <p>17.2 The Contractor shall be responsible for design of Temporary Works.</p> <p>17.3 The Project Manager's approval shall not alter the Contractor's responsibility for design of the Temporary Works.</p> <p>17.4 The Contractor shall obtain approval of third parties to the design of the Temporary Works, where required.</p> <p>17.5 All Drawings prepared by the Contractor for the execution of the temporary or permanent Works, are subject to prior approval by the Project Manager before this use.</p>
18. Health, Safety and Protection of the Environment	<p>18.1 The Contractor shall be responsible for the safety of all activities on the Site.</p> <p>18.2 The Contractor shall:</p> <ul style="list-style-type: none"> (a) comply with all applicable health and safety regulations and Laws; (b) comply with all applicable health and safety obligations specified in the Contract; (c) take care for the health and safety of all persons entitled to be on the Site and other places, if any, where the Works are being executed; (d) keep the Site and Works clear of unnecessary obstruction so as to avoid danger to these persons;

- (e) provide fencing, lighting, safe access, guarding and watching of the Works until the issue of the Contract Completion Certificate;
- (f) provide any Temporary Works (including roadways, footways, guards and fences) which may be necessary, because of the execution of the Works, for the use and protection of the public and of owners and occupiers of adjacent land;
- (g) provide health and safety training of Contractor's Personnel as appropriate and maintain training records;
- (h) actively engage the Contractor's Personnel in promoting understanding, and methods for, implementation of health and safety requirements, as well as in providing information to Contractor's Personnel, training on occupational safety and health, and provision of personal protective equipment without expense to the Contractor's Personnel;
- (i) put in place workplace processes for Contractor's Personnel to report work situations that they believe are not safe or healthy, and to remove themselves from a work situation which they have reasonable justification to believe presents an imminent and serious danger to their life or health.
- (j) Contractor's Personnel who remove themselves from such work situations shall not be required to return to work until necessary remedial action to correct the situation has been taken. Contractor's Personnel shall not be retaliated against or otherwise subject to reprisal or negative action for such reporting or removal;
- (k) where the Employer's Personnel, any other contractors employed by the Employer, and/or personnel of any legally constituted public authorities and private utility companies are employed in carrying out, on or near the site, of any work not included in the Contract, collaborate in applying the health and safety requirements, without prejudice to the responsibility of the relevant entities for the health and safety of their own personnel; and
- (l) establish and implement a system for regular (not less than six-monthly) review of health and safety performance and the working environment.

Subject to GCC Sub-Clause 16.2, the Contractor shall submit to the Project Manager for its approval a health and safety manual which has been specifically prepared for the Works, the Site and other places (if any) where the Contractor intends to execute the Works.

The health and safety manual shall be in addition to any other similar document required under applicable health and safety regulations and laws.

The health and safety manual shall set out all the health and safety requirements under the Contract,

- (a) which shall include at a minimum:
 - (i) the procedures to establish and maintain a safe working environment without risk to health at all workplaces, machinery, equipment and processes under the control of the Contractor, including control measures for chemical, physical and biological substances and agents;
 - (ii) details of the training to be provided, records to be kept;
 - (iii) the procedures for prevention, preparedness and response activities to be implemented in the case of an emergency event (i.e. an unanticipated incident, arising from both natural and man-made hazards, typically in the form of fire, explosions, leaks or spills, which may occur for a variety of different reasons including failure to implement operating procedures that are designed to prevent their occurrence, extreme weather or lack of early warning);
 - (iv) remedies for adverse impacts such as occupational injuries, deaths, disability and disease;
 - (v) the measures to be taken to avoid or minimize the potential for community exposure to water-borne, water-based, water-related, and vector-borne diseases,
 - (vi) the measures to be implemented to avoid or minimize the spread of communicable diseases (including transfer of Sexually Transmitted Diseases or Infections (STDs), such as HIV virus) and non-communicable diseases associated with the execution of the Works, taking into consideration differentiated exposure to and higher sensitivity of vulnerable groups. This includes taking measures to avoid or minimize the transmission of communicable diseases that may be associated with the influx of temporary or permanent Contract-related labor;
 - (vii) the policies and procedures on the management and quality of accommodation and welfare facilities if such accommodation and welfare facilities are

provided by the Contractor in accordance with GCC Sub-Clause 9.4.6; and

- (b) any other requirements stated in the Specification

18.3 Protection of the environment

The Contractor shall take all necessary measures to:

- 18.3.1 protect the environment (both on and off the Site); and
- 18.3.2 limit damage and nuisance to people and property resulting from pollution, noise and other results of the Contractor's operations and/ or activities.

The Contractor shall ensure that emissions, surface discharges, effluent and any other pollutants from the Contractor's activities shall exceed neither the values indicated in the Specifications, nor those prescribed by applicable laws.

In the event of damage to the environment, property and/or nuisance to people, on or off Site as a result of the Contractor's operations, the Contractor shall agree with the Project Manager the appropriate actions and time scale to remedy, as practicable, the damaged environment to its former condition. The Contractor shall implement such remedies at its cost to the satisfaction of the Project Manager.

19. Archaeological and Geological Findings

19.1 All fossils, coins, articles of value or antiquity, structures, groups of structures, and other remains or items of geological, archaeological, paleontological, historical, architectural or religious interest found on the Site shall be placed under the care and custody of the Employer. The Contractor shall:

- (a) take all reasonable precautions, including fencing-off the area or site of the finding, to avoid further disturbance and prevent Contractor's Personnel or other persons from removing or damaging any of these findings;
- (b) train relevant Contractor's Personnel on appropriate actions to be taken in the event of such findings; and
- (c) implement any other action consistent with the requirements of the Specifications and relevant laws.

The Contractor shall, as soon as practicable after discovery of any such finding, notify the Project Manager of such discoveries and carry out the Project Manager's instructions for dealing with them.

20. Possession of the Site

20.1 The Employer shall give possession of all parts of the Site to the Contractor. If possession of a part is not given by the date **stated in the PCC**, the Employer shall be deemed to have

delayed the start of the relevant activities, and this shall be a Compensation Event.

- 21. Access to the Site**
- 21.1 The Contractor shall allow the Project Manager and any person authorized by the Project Manager (including the Bank staff or consultants acting on the Bank's behalf, stakeholders and third parties, such as independent experts, local communities, or non-governmental organizations), including to carry out environmental and social audit, as appropriate, access to the Site and to any place where work in connection with the Contract is being carried out or is intended to be carried out.
- 22. Instructions, Inspections and Audits**
- 22.1 The Contractor shall carry out all instructions of the Project Manager which comply with the applicable laws where the Site is located.
- 22.2 The Contractor shall keep, and shall make all reasonable efforts to cause its Subcontractors and subconsultants to keep, accurate and systematic accounts and records in respect of the Works in such form and details as will clearly identify relevant time changes and costs.
- 22.3 Inspections & Audit by the Bank
- Pursuant to paragraph 2.2 e. of Appendix A to the GCC- Fraud and Corruption, the Contractor shall permit and shall cause its agents (where declared or not), subcontractors, subconsultants, service providers, suppliers, and personnel, to permit, the Bank and/or persons appointed by the Bank to inspect the site and/or the accounts, records and other documents relating to the procurement process, selection and/or contract execution, and to have such accounts, records and other documents audited by auditors appointed by the Bank. The Contractor's and its Subcontractors' and subconsultants' attention is drawn to GCC Sub-Clause 25.1 (Fraud and Corruption) which provides, inter alia, that acts intended to materially impede the exercise of the Bank's inspection and audit rights constitute a prohibited practice subject to contract termination (as well as to a determination of ineligibility pursuant to the Bank's prevailing sanctions procedures).
- 23. Appointment of the Adjudicator**
- 23.1 The Adjudicator shall be appointed jointly by the Employer and the Contractor, at the time of the Employer's issuance of the Letter of Acceptance. If, in the Letter of Acceptance, the Employer does not agree on the appointment of the Adjudicator, the Employer will request the Appointing Authority **designated in the PCC**, to appoint the Adjudicator within 14 days of receipt of such request.
- 23.2 Should the Adjudicator resign or die, or should the Employer and the Contractor agree that the Adjudicator is not functioning

in accordance with the provisions of the Contract, a new Adjudicator shall be jointly appointed by the Employer and the Contractor. In case of disagreement between the Employer and the Contractor, within 30 days, the Adjudicator shall be designated by the Appointing Authority **designated in the PCC** at the request of either party, within 14 days of receipt of such request.

24. Procedure for Disputes

- 24.1 If the Contractor believes that a decision taken by the Project Manager was either outside the authority given to the Project Manager by the Contract or that the decision was wrongly taken, the decision shall be referred to the Adjudicator within 14 days of the notification of the Project Manager's decision.
- 24.2 The Adjudicator shall give a decision in writing within 28 days of receipt of a notification of a dispute.
- 24.3 The Adjudicator shall be paid by the hour at the **rate specified in the PCC**, together with reimbursable expenses of the types **specified in the PCC**, and the cost shall be divided equally between the Employer and the Contractor, whatever decision is reached by the Adjudicator. Either party may refer a decision of the Adjudicator to an Arbitrator within 28 days of the Adjudicator's written decision. If neither party refers the dispute to arbitration within the above 28 days, the Adjudicator's decision shall be final and binding.
- 24.4 The arbitration shall be conducted in accordance with the arbitration procedures published by the institution named and in the place **specified in the PCC**.

25. Fraud and Corruption

- 25.1 The Bank requires compliance with the Bank's Anti-Corruption Guidelines and its prevailing sanctions policies and procedures as set forth in the WBG's Sanctions Framework, as set forth in Appendix A to the GCC.
- 25.2 The Employer requires the Contractor to disclose any commissions or fees that may have been paid or are to be paid to agents or any other party with respect to the bidding process or execution of the Contract. The information disclosed must include at least the name and address of the agent or other party, the amount and currency, and the purpose of the commission, gratuity or fee.

26. Stakeholder Engagement

- 26.1 The Contractor shall provide relevant contract-related information, as the Employer and/or Project Manager may reasonably request to conduct Stakeholder engagements. "Stakeholder" refers to individuals or groups who:
- (i) are affected or likely to be affected by the Contract; and
 - (ii) may have an interest in the Contract.

The Contractor may also directly participate in Stakeholder engagements, as the Employer and/or Project Manager may reasonably request

27. Suppliers (other than Subcontractors)

27.1 **Forced Labor:** The Contractor shall take measures to require its suppliers (other than Subcontractors) not to employ or engage forced labor including trafficked persons as described in GCC Sub-Clause 9.4.14. If forced labor/trafficking cases are identified, the Contractor shall take measures to require the suppliers to take appropriate steps to remedy them. Where the supplier does not remedy the situation, the Contractor shall within a reasonable period substitute the supplier with a supplier that is able to manage such risks.

27.2 *Child Labor:* The Contractor shall take measures to require its suppliers (other than Subcontractors) not to employ or engage child labor as described in GCC Sub-Clause 9.4.15. If child labor cases are identified, the Contractor shall take measures to require the suppliers to take appropriate steps to remedy them. Where the supplier does not remedy the situation, the Contractor shall within a reasonable period substitute the supplier with a supplier that is able to manage such risks.

27.3 *Serious Safety Issues:* The Contractor, including its Subcontractors, shall comply with all applicable safety obligations, including as stated in GCC Sub-Clause 18.2. The Contractor shall also take measures to require its suppliers (other than Subcontractors) to adopt procedures and mitigation measures adequate to address safety issues related to their personnel. If serious safety issues are identified, the Contractor shall take measures to require the suppliers to take appropriate steps to remedy them. Where the supplier does not remedy the situation, the Contractor shall within a reasonable period substitute the supplier with a supplier that is able to manage such risks.

27.4 *Obtaining natural resource materials in relation to supplier:* The Contractor shall obtain natural resource *materials* from suppliers that can demonstrate, through compliance with the applicable verification and/ or certification requirements, that obtaining such materials is not contributing to the risk of significant conversion or significant degradation of natural or critical habitats such as unsustainably harvested wood products, gravel or sand extraction from river beds or beaches.

If a supplier cannot continue to demonstrate that obtaining such materials is not contributing to the risk of significant conversion or significant degradation of natural or critical habitats, the Contractor shall within a reasonable period substitute the supplier with a supplier that is able to demonstrate that they are not significantly adversely impacting

the habitats.

28. Code of Conduct

28.1 The Contractor shall have a Code of Conduct for the Contractor's Personnel.

The Contractor shall take all necessary measures to ensure that each Contractor's Personnel is made aware of the Code of Conduct including specific behaviors that are prohibited, and understands the consequences of engaging in such prohibited behaviors.

These measures include providing instructions and documentation that can be understood by the Contractor's Personnel and seeking to obtain that person's signature acknowledging receipt of such instructions and/or documentation, as appropriate.

The Contractor shall also ensure that the Code of Conduct is visibly displayed in multiple locations on the Site and any other place where the Works will be carried out, as well as in areas outside the Site accessible to the local community and project affected people. The posted Code of Conduct shall be provided in languages comprehensible to Contractor's Personnel, Employer's Personnel and the local community.

The Contractor's Management Strategy and Implementation Plans shall include appropriate processes for the Contractor to verify compliance with these obligations.

29. Security of the Site

29.1 The Contractor shall be responsible for the security of the Site, and:

- (a) for keeping unauthorized persons off the Site;
- (b) authorized persons shall be limited to the Contractor's Personnel, the Employer's Personnel, and to any other personnel identified as authorized personnel (including the Employer's other contractors on the Site), by a notice from the Employer or the Project Manager to the Contractor.

Subject to GCC Sub-Clause 16.2, the Contractor shall submit for the Project Manager's No-objection a security management plan that sets out the security arrangements for the Site

The Contractor shall (i) conduct appropriate background checks on any personnel retained to provide security; (ii) train the security personnel adequately (or determine that they are properly trained) in the use of force (and where applicable, firearms), and appropriate conduct towards Contractor's Personnel, Employer's Personnel and affected communities; and (iii) require the security personnel to act within the applicable Laws and any requirements set out in the

Specifications.

The Contractor shall not permit any use of force by security personnel in providing security except when used for preventive and defensive purposes in proportion to the nature and extent of the threat.

In making security arrangements, the Contractor shall also comply with any additional requirements stated in the Specification.”

B. Time Control

30. Program and Progress Reports

- 30.1 Within the time **stated in the PCC**, after the date of the Letter of Acceptance, the Contractor shall submit to the Project Manager for approval a Program showing the general methods, arrangements, order, and timing for all the activities in the Works. In the case of a lump-sum contract, the activities in the Program shall be consistent with those in the Activity Schedule. The Project Manager’s approval of the Program shall not alter the Contractor’s obligations. The Contractor may revise the Program and submit it to the Project Manager again at any time. A revised Program shall show the effect of Variations and Compensation Events.
- 30.2 An update of the Program shall be a program showing the actual progress achieved on each activity and the effect of the progress achieved on the timing of the remaining work, including any changes to the sequence of the activities.
- 30.3 The Contractor shall monitor progress of the Works and submit to the Project manager progress report and any updated Program showing the actual progress achieved and the effect of the progress achieved on the timing of the remaining Works, including any changes to the sequence of the activities, at intervals no longer than the period **stated in the PCC**. If the Contractor does not submit an updated Program within this period, the Project Manager may withhold the amount **stated in the PCC** from the next payment certificate and continue to withhold this amount until the next payment after the date on which the overdue Program has been submitted. In the case of lump-sum Contract, the Contractor shall provide an updated Activity Schedule within 14 days of being instructed to by the Project Manager.
- 30.4 Unless otherwise stated in the Specifications, each progress report shall include the Environmental and Social (ES) metrics set out in Appendix B.
- 30.5 In addition to the progress reports, the Contractor shall inform the Project Manager immediately of any allegation, incident or accident in the Site, which has or is likely to have a significant adverse effect on the environment, the affected communities,

the public, Employer's Personnel, Project Manager's personnel or Contractor's Personnel. This includes, but is not limited to, any incident or accident causing fatality or serious injury; significant adverse effects or damage to private property; or any allegation of SEA and/or SH. In case of SEA and/or SH, while maintaining confidentiality as appropriate, the type of allegation (sexual exploitation, sexual abuse or sexual harassment), gender and age of the person who experienced the alleged incident should be included in the information.

The Contractor, upon becoming aware of the allegation, incident or accident, shall also immediately inform the Project Manager of any such incident or accident on the Subcontractors' or suppliers' premises relating to the Works which has or is likely to have a significant adverse effect on the environment, the affected communities, the public, Employer's Personnel, or Contractor's, its Subcontractors' and suppliers' personnel. The notification shall provide sufficient detail regarding such incidents or accidents. The Contractor shall provide full details of such incidents or accidents to the Project Manager within the timeframe agreed with the Project Manager.

The Contractor shall require its Subcontractors and suppliers (other than Subcontractors) to immediately notify the Contractor of any incidents or accidents referred to in this Subclause.

31. Extension of the Intended Completion Date

31.1 The Project Manager shall extend the Intended Completion Date if a Compensation Event occurs or a Variation is issued which makes it impossible for Completion to be achieved by the Intended Completion Date without the Contractor taking steps to accelerate the remaining work, which would cause the Contractor to incur additional cost.

31.2 The Project Manager shall decide whether and by how much to extend the Intended Completion Date within 21 days of the Contractor asking the Project Manager for a decision upon the effect of a Compensation Event or Variation and submitting full supporting information. If the Contractor has failed to give early warning of a delay or has failed to cooperate in dealing with a delay, the delay by this failure shall not be considered in assessing the new Intended Completion Date.

32. Acceleration

32.1 When the Employer wants the Contractor to finish before the Intended Completion Date, the Project Manager shall obtain priced proposals for achieving the necessary acceleration from the Contractor. If the Employer accepts these proposals, the Intended Completion Date shall be adjusted accordingly and confirmed by both the Employer and the Contractor.

32.2 If the Contractor's priced proposals for an acceleration are accepted by the Employer, they are incorporated in the

Contract Price and treated as a Variation.

- 33. Delays Ordered by the Project Manager** 33.1 The Project Manager may instruct the Contractor to delay the start or progress of any activity within the Works.
- 34. Management Meetings** 34.1 Either the Project Manager or the Contractor may require the other to attend a management meeting. The business of a management meeting shall be to review the plans for remaining work and to deal with matters raised in accordance with the early warning procedure.
- 34.2 The Project Manager shall record the business of management meetings and provide copies of the record to those attending the meeting and to the Employer. The responsibility of the parties for actions to be taken shall be decided by the Project Manager either at the management meeting or after the management meeting and stated in writing to all who attended the meeting.
- 35. Early Warning** 35.1 The Contractor shall warn the Project Manager at the earliest opportunity of specific likely future events or circumstances that may adversely affect the quality of the work, increase the Contract Price, or delay the execution of the Works. The Project Manager may require the Contractor to provide an estimate of the expected effect of the future event or circumstance on the Contract Price and Completion Date. The estimate shall be provided by the Contractor as soon as reasonably possible.
- 35.2 The Contractor shall cooperate with the Project Manager in making and considering proposals for how the effect of such an event or circumstance can be avoided or reduced by anyone involved in the work and in carrying out any resulting instruction of the Project Manager.

C. Quality Control

- 36. Identifying Defects** 36.1 The Project Manager shall check the Contractor's work and notify the Contractor of any Defects that are found. Such checking shall not affect the Contractor's responsibilities. The Project Manager may instruct the Contractor to search for a Defect and to uncover and test any work that the Project Manager considers may have a Defect.
- 37. Tests** 37.1 If the Project Manager instructs the Contractor to carry out a test not specified in the Specifications to check whether any work has a Defect and the test shows that it does, the Contractor shall pay for the test and any samples. If there is no Defect, the test shall be a Compensation Event.

- 38. Correction of Defects**
- 38.1 The Project Manager shall give notice to the Contractor of any Defects before the end of the Defects Liability Period, which begins at Completion, and is **defined in the PCC**. The Defects Liability Period shall be extended for as long as Defects remain to be corrected.
- 38.2 Every time notice of a Defect is given, the Contractor shall correct the notified Defect within the length of time specified by the Project Manager's notice.
- 39. Uncorrected Defects**
- 39.1 If the Contractor has not corrected a Defect within the time specified in the Project Manager's notice, the Project Manager shall assess the cost of having the Defect corrected, and the Contractor shall pay this amount.

D. Cost Control

- 40. Contract Price²**
- 40.1 The Bill of Quantities shall contain priced items for the Works to be performed by the Contractor. The Bill of Quantities is used to calculate the Contract Price. The Contractor will be paid for the quantity of the work accomplished at the rate in the Bill of Quantities for each item.
- 41. Changes in the Contract Price³**
- 41.1 If the final quantity of the work done differs from the quantity in the Bill of Quantities for the particular item by more than 25 percent, provided the change exceeds 1 percent of the Initial Contract Price, the Project Manager shall adjust the rate to allow for the change. The Project Manager shall not adjust rates from changes in quantities if thereby the Initial Contract Price is exceeded by more than 15 percent, except with the prior approval of the Employer.
- 41.2 If requested by the Project Manager, the Contractor shall provide the Project Manager with a detailed cost breakdown of any rate in the Bill of Quantities.
- 42. Variations**
- 42.1 All Variations shall be included in updated Programs⁴ produced by the Contractor.

² In lump-sum contracts, replace GCC Sub-Clauses 40.1 as follows:

40.1 The Contractor shall provide updated Activity Schedules within 14 days of being instructed to by the Project Manager. The Activity Schedule shall contain the priced activities for the Works to be performed by the Contractor. The Activity Schedule is used to monitor and control the performance of activities on which basis the Contractor will be paid. If payment for materials on site shall be made separately, the Contractor shall show delivery of Materials to the Site separately on the Activity Schedule.

³ In lump-sum contracts, replace entire GCC Clause 41 with new GCC Sub-Clause 41.1, as follows:

41.1 The Activity Schedule shall be amended by the Contractor to accommodate changes of Program or method of working made at the Contractor's own discretion. Prices in the Activity Schedule shall not be altered when the Contractor makes such changes to the Activity Schedule.

⁴ In lump-sum contracts, add "and Activity Schedules" after "Programs."

- 42.2 The Contractor shall provide the Project Manager with a quotation for carrying out the Variation when requested to do so by the Project Manager. The Contractor shall also provide information of any ES risks and impacts of the Variation. The Project Manager shall assess the quotation, which shall be given within seven (7) days of the request or within any longer period stated by the Project Manager and before the Variation is ordered.
- 42.3 If the Contractor's quotation is unreasonable, the Project Manager may order the Variation and make a change to the Contract Price, which shall be based on the Project Manager's own forecast of the effects of the Variation on the Contractor's costs.
- 42.4 If the Project Manager decides that the urgency of varying the work would prevent a quotation being given and considered without delaying the work, no quotation shall be given and the Variation shall be treated as a Compensation Event.
- 42.5 The Contractor shall not be entitled to additional payment for costs that could have been avoided by giving early warning.
- 42.6 If the work in the Variation corresponds to an item description in the Bill of Quantities and if, in the opinion of the Project Manager, the quantity of work above the limit stated in GCC Sub-Clause 41.1 or the timing of its execution do not cause the cost per unit of quantity to change, the rate in the Bill of Quantities shall be used to calculate the value of the Variation. If the cost per unit of quantity changes, or if the nature or timing of the work in the Variation does not correspond with items in the Bill of Quantities, the quotation by the Contractor shall be in the form of new rates for the relevant items of work.⁵
- 42.7 Value Engineering: The Contractor may prepare, at its own cost, a value engineering proposal at any time during the performance of the contract. The value engineering proposal shall, at a minimum, include the following;
- (a) the proposed change(s), and a description of the difference to the existing contract requirements;
 - (b) a full cost/benefit analysis of the proposed change(s) including a description and estimate of costs (including life cycle cost) the Employer may incur in implementing the value engineering proposal;
 - (c) a description of any effect(s) of the change on performance/functionality; and

⁵ In lump-sum contracts, delete this paragraph.

- (d) a description of the proposed work to be performed, a program for its execution and sufficient ES information to enable an evaluation of ES risks and impacts.

The Employer may accept the value engineering proposal if the proposal demonstrates benefits that:

- (a) accelerates the contract completion period; or
 - (b) reduces the Contract Price or the life cycle costs to the Employer; or
 - (c) improves the quality, efficiency, safety or sustainability of the Facilities; or
 - (d) yields any other benefits to the Employer,
- without compromising the functionality of the Works.

If the value engineering proposal is approved by the Employer and results in:

- (a) a reduction of the Contract Price; the amount to be paid to the Contractor shall be the **percentage specified in the PCC** of the reduction in the Contract Price; or
- (b) an increase in the Contract Price; but results in a reduction in life cycle costs due to any benefit described in (a) to (d) above, the amount to be paid to the Contractor shall be the full increase in the Contract Price.

43. Cash Flow Forecasts

43.1 When the Program,⁶ is updated, the Contractor shall provide the Project Manager with an updated cash flow forecast. The cash flow forecast shall include different currencies, as defined in the Contract, converted as necessary using the Contract exchange rates.

44. Payment Certificates

44.1 The Contractor shall submit to the Project Manager monthly statements of the estimated value of the work executed less the cumulative amount certified previously.

44.2 The Project Manager shall check the Contractor's monthly statement and certify the amount to be paid to the Contractor.

44.3 The value of work executed shall be determined by the Project Manager.

44.4 The value of work executed shall comprise the value of the quantities of work in the Bill of Quantities that have been completed.⁷

44.5 The value of work executed shall include the valuation of

⁶ In lump-sum contracts, add "or Activity Schedule" after "Program."

⁷ In lump-sum contracts, replace this paragraph with the following: "The value of work executed shall comprise the value of completed activities in the Activity Schedule."

Variations and Compensation Events.

- 44.6 The Project Manager may exclude any item certified in a previous certificate or reduce the proportion of any item previously certified in any certificate in the light of later information.
- 44.7 If the Contractor was, or is, failing to perform any ES obligations or work under the Contract, the value of this work or obligation, as determined by the Project Manager, may be withheld until the work or obligation has been performed, and/or the cost of rectification or replacement, as determined by the Project Manager, may be withheld until rectification or replacement has been completed. Failure to perform includes, but is not limited to the following:
- (a) failure to comply with any ES obligations or work described in the Works' Requirements which may include: working outside site boundaries, excessive dust, failure to keep public roads in a safe usable condition, damage to offsite vegetation, pollution of water courses from oils or sedimentation, contamination of land e.g. from oils, human waste, damage to archeology or cultural heritage features, air pollution as a result of unauthorized and/or inefficient combustion;
 - (b) failure to regularly review C-ESMP and/or update it in a timely manner to address emerging ES issues, or anticipated risks or impacts;
 - (c) failure to implement the C-ESMP e.g. failure to provide required training or sensitization;
 - (d) failing to have appropriate consents/permits prior to undertaking Works or related activities;
 - (e) failure to submit ES report/s (as described in Appendix B), or failure to submit such reports in a timely manner;
 - (f) failure to implement remediation as instructed by the Project Manager within the specified timeframe (e.g. remediation addressing non-compliance/s).

45. Payments

- 45.1 Payments shall be adjusted for deductions for advance payments and retention. The Employer shall pay the Contractor the amounts certified by the Project Manager within 28 days of the date of each certificate. If the Employer makes a late payment, the Contractor shall be paid interest on the late payment in the next payment. Interest shall be calculated from the date by which the payment should have been made up to the date when the late payment is made at the prevailing rate of interest for commercial borrowing for each of the currencies in which payments are made.

- 45.2 If an amount certified is increased in a later certificate or as a result of an award by the Adjudicator or an Arbitrator, the Contractor shall be paid interest upon the delayed payment as set out in this clause. Interest shall be calculated from the date upon which the increased amount would have been certified in the absence of dispute.
- 45.3 Unless otherwise stated, all payments and deductions shall be paid or charged in the proportions of currencies comprising the Contract Price.
- 45.4 Items of the Works for which no rate or price has been entered in shall not be paid for by the Employer and shall be deemed covered by other rates and prices in the Contract.

46. Compensation Events

- 46.1 The following shall be Compensation Events:
- (a) The Employer does not give access to a part of the Site by the Site Possession Date pursuant to GCC Sub-Clause 20.1.
 - (b) The Employer modifies the Schedule of Other Contractors in a way that affects the work of the Contractor under the Contract.
 - (c) The Project Manager orders a delay or does not issue Drawings, Specifications, or instructions required for execution of the Works on time.
 - (d) The Project Manager instructs the Contractor to uncover or to carry out additional tests upon work, which is then found to have no Defects.
 - (e) The Project Manager unreasonably does not approve a subcontract to be let.
 - (f) Ground conditions are substantially more adverse than could reasonably have been assumed before issuance of the Letter of Acceptance from the information issued to bidders (including the Site Investigation Reports), from information available publicly and from a visual inspection of the Site.
 - (g) The Project Manager gives an instruction for dealing with an unforeseen condition, caused by the Employer, or additional work required for safety or other reasons.
 - (h) Other contractors, public authorities, utilities, or the Employer does not work within the dates and other constraints stated in the Contract, and they cause delay or extra cost to the Contractor.
 - (i) The advance payment is delayed.
 - (j) The effects on the Contractor of any of the Employer's Risks.

(k) The Project Manager unreasonably delays issuing a Certificate of Completion.

46.2 If a Compensation Event would cause additional cost or would prevent the work being completed before the Intended Completion Date, the Contract Price shall be increased and/or the Intended Completion Date shall be extended. The Project Manager shall decide whether and by how much the Contract Price shall be increased and whether and by how much the Intended Completion Date shall be extended.

46.3 As soon as information demonstrating the effect of each Compensation Event upon the Contractor's forecast cost has been provided by the Contractor, it shall be assessed by the Project Manager, and the Contract Price shall be adjusted accordingly. If the Contractor's forecast is deemed unreasonable, the Project Manager shall adjust the Contract Price based on the Project Manager's own forecast. The Project Manager shall assume that the Contractor shall react competently and promptly to the event.

46.4 The Contractor shall not be entitled to compensation to the extent that the Employer's interests are adversely affected by the Contractor's not having given early warning or not having cooperated with the Project Manager.

47. Tax

47.1 The Project Manager shall adjust the Contract Price if taxes, duties, and other levies are changed between the date 28 days before the submission of bids for the Contract and the date of the last Completion certificate. The adjustment shall be the change in the amount of tax payable by the Contractor, provided such changes are not already reflected in the Contract Price or are a result of GCC Clause 49.

48. Currencies

48.1 Where payments are made in currencies other than the currency of the Employer's country **specified in the PCC**, the exchange rates used for calculating the amounts to be paid shall be the exchange rates stated in the Contractor's Bid.

49. Price Adjustment

49.1 Prices shall be adjusted for fluctuations in the cost of inputs only if **provided for in the PCC**. If so provided, the amounts certified in each payment certificate, before deducting for Advance Payment, shall be adjusted by applying the respective price adjustment factor to the payment amounts due in each currency. A separate formula of the type specified below applies to each Contract currency:

$$P_c = A_c + B_c I_{mc}/I_{oc}$$

where:

P_c is the adjustment factor for the portion of the Contract

Price payable in a specific currency “c.”

A_c and B_c are coefficients⁸ **specified in the PCC**, representing the nonadjustable and adjustable portions, respectively, of the Contract Price payable in that specific currency “c;” and

I_{mc} is the index prevailing at the end of the month being invoiced and I_{oc} is the index prevailing 28 days before Bid opening for inputs payable; both in the specific currency “c.”

49.2 If the value of the index is changed after it has been used in a calculation, the calculation shall be corrected and an adjustment made in the next payment certificate. The index value shall be deemed to take account of all changes in cost due to fluctuations in costs.

50. Retention

50.1 The Employer shall retain from each payment due to the Contractor the proportion **stated in the PCC** until Completion of the whole of the Works.

50.2 Upon the issue of a Certificate of Completion of the Works by the Project Manager, in accordance with GCC Sub-Clause 57.1, half the total amount retained shall be repaid to the Contractor and half when the Defects Liability Period has passed and the Project Manager has certified that all Defects notified by the Project Manager to the Contractor before the end of this period have been corrected. The Contractor may substitute retention money with an “on demand” Bank guarantee.

51. Liquidated Damages

51.1 The Contractor shall pay liquidated damages to the Employer at the rate per day **stated in the PCC** for each day that the Completion Date is later than the Intended Completion Date. The total amount of liquidated damages shall not exceed the amount **defined in the PCC**. The Employer may deduct liquidated damages from payments due to the Contractor. Payment of liquidated damages shall not affect the Contractor’s liabilities.

51.2 If the Intended Completion Date is extended after liquidated damages have been paid, the Project Manager shall correct any overpayment of liquidated damages by the Contractor by adjusting the next payment certificate. The Contractor shall be paid interest on the overpayment, calculated from the date of

⁸ The sum of the two coefficients A_c and B_c should be 1 (one) in the formula for each currency. Normally, both coefficients shall be the same in the formulae for all currencies, since coefficient A_c , for the nonadjustable portion of the payments, is a very approximate figure (usually 0.15) to take account of fixed cost elements or other nonadjustable components. The sum of the adjustments for each currency are added to the Contract Price.

payment to the date of repayment, at the rates specified in GCC Sub-Clause 45.1.

52. Bonus

52.1 The Contractor shall be paid a Bonus calculated at the rate per calendar day **stated in the PCC** for each day (less any days for which the Contractor is paid for acceleration) that the Completion is earlier than the Intended Completion Date. The Project Manager shall certify that the Works are complete, although they may not be due to be complete.

53. Advance Payment

53.1 The Employer shall make advance payment to the Contractor of the amounts **stated in the PCC** by the date **stated in the PCC**, against provision by the Contractor of an Unconditional Bank Guarantee in a form and by a bank acceptable to the Employer in amounts and currencies equal to the advance payment. The Guarantee shall remain effective until the advance payment has been repaid, but the amount of the Guarantee shall be progressively reduced by the amounts repaid by the Contractor. Interest shall not be charged on the advance payment.

53.2 The Contractor is to use the advance payment only to pay for Equipment, Plant, Materials, and mobilization expenses required specifically for execution of the Contract. The Contractor shall demonstrate that advance payment has been used in this way by supplying copies of invoices or other documents to the Project Manager.

53.3 The advance payment shall be repaid by deducting proportionate amounts from payments otherwise due to the Contractor, following the schedule of completed percentages of the Works on a payment basis. No account shall be taken of the advance payment or its repayment in assessing valuations of work done, Variations, price adjustments, Compensation Events, Bonuses, or Liquidated Damages.

54. Securities

54.1 The Performance Security shall be provided to the Employer no later than the date specified in the Letter of Acceptance and shall be issued in an amount **specified in the PCC**, by a bank or surety acceptable to the Employer, and denominated in the types and proportions of the currencies in which the Contract Price is payable. The Performance Security shall be valid until a date 28 days from the date of issue of the Certificate of Completion in the case of a Bank Guarantee, and until one year from the date of issue of the Certificate of Completion in the case of a Performance Bond.

55. Dayworks

55.1 If applicable, the Dayworks rates in the Contractor's Bid shall be used only when the Project Manager has given written instructions in advance for additional work to be paid for in

that way.

55.2 All work to be paid for as Dayworks shall be recorded by the Contractor on forms approved by the Project Manager. Each completed form shall be verified and signed by the Project Manager within two days of the work being done.

55.3 The Contractor shall be paid for Dayworks subject to obtaining signed Dayworks forms.

56. Cost of Repairs

56.1 Loss or damage to the Works or Materials to be incorporated in the Works between the Start Date and the end of the Defects Correction periods shall be remedied by the Contractor at the Contractor's cost if the loss or damage arises from the Contractor's acts or omissions.

E. Finishing the Contract

57. Completion

57.1 The Contractor shall request the Project Manager to issue a Certificate of Completion of the Works, and the Project Manager shall do so upon deciding that the whole of the Works is completed.

58. Taking Over

58.1 The Employer shall take over the Site and the Works within seven days of the Project Manager's issuing a certificate of Completion.

59. Final Account

59.1 The Contractor shall supply the Project Manager with a detailed account of the total amount that the Contractor considers payable under the Contract before the end of the Defects Liability Period. The Project Manager shall issue a Defects Liability Certificate and certify any final payment that is due to the Contractor within 56 days of receiving the Contractor's account if it is correct and complete. If it is not, the Project Manager shall issue within 56 days a schedule that states the scope of the corrections or additions that are necessary. If the Final Account is still unsatisfactory after it has been resubmitted, the Project Manager shall decide on the amount payable to the Contractor and issue a payment certificate.

60. Operating and Maintenance Manuals

60.1 If "as built" Drawings and/or operating and maintenance manuals are required, the Contractor shall supply them by the dates **stated in the PCC**.

60.2 If the Contractor does not supply the Drawings and/or manuals by the dates **stated in the PCC** pursuant to GCC Sub-Clause 60.1, or they do not receive the Project Manager's approval, the Project Manager shall withhold the amount **stated in the PCC** from payments due to the Contractor.

61. Termination

61.1 The Employer or the Contractor may terminate the Contract if the other party causes a fundamental breach of the Contract.

61.2 Fundamental breaches of Contract shall include, but shall not be limited to, the following:

- (a) the Contractor stops work for 28 days when no stoppage of work is shown on the current Program and the stoppage has not been authorized by the Project Manager;
- (b) the Project Manager instructs the Contractor to delay the progress of the Works, and the instruction is not withdrawn within 28 days;
- (c) the Employer or the Contractor is made bankrupt or goes into liquidation other than for a reconstruction or amalgamation;
- (d) a payment certified by the Project Manager is not paid by the Employer to the Contractor within 84 days of the date of the Project Manager's certificate;
- (e) the Project Manager gives Notice that failure to correct a particular Defect is a fundamental breach of Contract and the Contractor fails to correct it within a reasonable period of time determined by the Project Manager;
- (f) the Contractor does not maintain a Security, which is required;
- (g) the Contractor has delayed the completion of the Works by the number of days for which the maximum amount of liquidated damages can be paid, as **defined in the PCC**; or
- (h) if the Contractor, in the judgment of the Employer has engaged in Fraud and Corruption, as defined in paragraph 2.2 a of the Appendix A to the GCC, in competing for or in executing the Contract, then the Employer may, after giving fourteen (14) days written notice to the Contractor, terminate the Contract and expel him from the Site.

61.3 Notwithstanding the above, the Employer may terminate the Contract for convenience.

61.4 If the Contract is terminated, the Contractor shall stop work immediately, make the Site safe and secure, and leave the Site as soon as reasonably possible.

61.5 When either party to the Contract gives notice of a breach of Contract to the Project Manager for a cause other than those

listed under GCC Sub-Clause 61.2 above, the Project Manager shall decide whether the breach is fundamental or not.

62. Payment upon Termination

- 62.1 If the Contract is terminated because of a fundamental breach of Contract by the Contractor, the Project Manager shall issue a certificate for the value of the work done and Materials ordered less advance payments received up to the date of the issue of the certificate and less the percentage to apply to the value of the work not completed, as **specified in the PCC**. Additional Liquidated Damages shall not apply. If the total amount due to the Employer exceeds any payment due to the Contractor, the difference shall be a debt payable to the Employer.
- 62.2 If the Contract is terminated for the Employer's convenience or because of a fundamental breach of Contract by the Employer, the Project Manager shall issue a certificate for the value of the work done, Materials ordered, the reasonable cost of removal of Equipment, repatriation of the Contractor's personnel employed solely on the Works, and the Contractor's costs of protecting and securing the Works, and less advance payments received up to the date of the certificate.

63. Property

- 63.1 All Materials on the Site, Plant, Equipment, Temporary Works, and Works shall be deemed to be the property of the Employer if the Contract is terminated because of the Contractor's default.

64. Release from Performance

- 64.1 If the Contract is frustrated by the outbreak of war or by any other event entirely outside the control of either the Employer or the Contractor, the Project Manager shall certify that the Contract has been frustrated. The Contractor shall make the Site safe and stop work as quickly as possible after receiving this certificate and shall be paid for all work carried out before receiving it and for any work carried out afterwards to which a commitment was made.

65. Suspension of Bank Loan or Credit

- 65.1 In the event that the Bank suspends the Loan or Credit to the Employer, from which part of the payments to the Contractor are being made:
- (a) The Employer is obligated to notify the Contractor of such suspension within 7 days of having received the Bank's suspension notice.
 - (b) If the Contractor has not received sums due to it within the 28 days for payment provided for in GCC Sub-Clause 45.1, the Contractor may immediately issue a 14-day termination notice.

APPENDIX A TO GENERAL CONDITIONS

Fraud and Corruption

(Text in this Appendix shall not be modified)

1. Purpose

1.1 The Bank's Anti-Corruption Guidelines and this annex apply with respect to procurement under Bank Investment Project Financing operations.

2. Requirements

2.1 The Bank requires that Borrowers (including beneficiaries of Bank financing); bidders (applicants/proposers), consultants, contractors and suppliers; any sub-contractors, sub-consultants, service providers or suppliers; any agents (whether declared or not); and any of their personnel, observe the highest standard of ethics during the procurement process, selection and contract execution of Bank-financed contracts, and refrain from Fraud and Corruption.

2.2 To this end, the Bank:

a. Defines, for the purposes of this provision, the terms set forth below as follows:

- i. "corrupt practice" is the offering, giving, receiving, or soliciting, directly or indirectly, of anything of value to influence improperly the actions of another party;
- ii. "fraudulent practice" is any act or omission, including misrepresentation, that knowingly or recklessly misleads, or attempts to mislead, a party to obtain financial or other benefit or to avoid an obligation;
- iii. "collusive practice" is an arrangement between two or more parties designed to achieve an improper purpose, including to influence improperly the actions of another party;
- iv. "coercive practice" is impairing or harming, or threatening to impair or harm, directly or indirectly, any party or the property of the party to influence improperly the actions of a party;
- v. "obstructive practice" is:
 - (a) deliberately destroying, falsifying, altering, or concealing of evidence material to the investigation or making false statements to investigators in order to materially impede a Bank investigation into allegations of a corrupt, fraudulent, coercive, or collusive practice; and/or threatening, harassing, or intimidating any party to prevent it from disclosing its knowledge of matters relevant to the investigation or from pursuing the investigation; or

- (b) acts intended to materially impede the exercise of the Bank's inspection and audit rights provided for under paragraph 2.2 e. below.
- b. Rejects a proposal for award if the Bank determines that the firm or individual recommended for award, any of its personnel, or its agents, or its sub-consultants, sub-contractors, service providers, suppliers and/ or their employees, has, directly or indirectly, engaged in corrupt, fraudulent, collusive, coercive, or obstructive practices in competing for the contract in question;
- c. In addition to the legal remedies set out in the relevant Legal Agreement, may take other appropriate actions, including declaring misprocurement, if the Bank determines at any time that representatives of the Borrower or of a recipient of any part of the proceeds of the loan engaged in corrupt, fraudulent, collusive, coercive, or obstructive practices during the procurement process, selection and/or execution of the contract in question, without the Borrower having taken timely and appropriate action satisfactory to the Bank to address such practices when they occur, including by failing to inform the Bank in a timely manner at the time they knew of the practices;
- d. Pursuant to the Bank's Anti- Corruption Guidelines and in accordance with the Bank's prevailing sanctions policies and procedures, may sanction a firm or individual, either indefinitely or for a stated period of time, including by publicly declaring such firm or individual ineligible (i) to be awarded or otherwise benefit from a Bank-financed contract, financially or in any other manner;⁹ (ii) to be a nominated¹⁰ sub-contractor, consultant, manufacturer or supplier, or service provider of an otherwise eligible firm being awarded a Bank-financed contract; and (iii) to receive the proceeds of any loan made by the Bank or otherwise to participate further in the preparation or implementation of any Bank-financed project;
- e. Requires that a clause be included in bidding/request for proposals documents and in contracts financed by a Bank loan, requiring (i) bidders(applicants/proposers), consultants, contractors, and suppliers, and their sub-contractors, sub-consultants, service providers, suppliers, agents personnel, permit the Bank to inspect¹¹ all accounts, records and other documents relating to the procurement process, selection and/or contract execution, and to have them audited by auditors appointed by the Bank.

⁹ For the avoidance of doubt, a sanctioned party's ineligibility to be awarded a contract shall include, without limitation, (i) applying for pre-qualification, expressing interest in a consultancy, and bidding, either directly or as a nominated sub-contractor, nominated consultant, nominated manufacturer or supplier, or nominated service provider, in respect of such contract, and (ii) entering into an addendum or amendment introducing a material modification to any existing contract.

¹⁰ A nominated sub-contractor, nominated consultant, nominated manufacturer or supplier, or nominated service provider (different names are used depending on the particular bidding document) is one which has been: (i) included by the bidder in its pre-qualification application or bid because it brings specific and critical experience and know-how that allow the bidder to meet the qualification requirements for the particular bid; or (ii) appointed by the Borrower.

¹¹ Inspections in this context usually are investigative (i.e., forensic) in nature. They involve fact-finding activities undertaken by the Bank or persons appointed by the Bank to address specific matters related to investigations/audits, such as evaluating the veracity of an allegation of possible Fraud and Corruption, through the appropriate mechanisms. Such activity includes but is not limited to: accessing and examining a firm's or individual's financial records and information, and making copies thereof as relevant; accessing and examining any other documents, data and information (whether in hard copy or electronic format) deemed relevant for the investigation/audit, and making copies thereof as relevant; interviewing staff and other relevant individuals; performing physical inspections and site visits; and obtaining third party verification of information.

APPENDIX B

Environmental and Social (ES) Metrics for Progress Reports

[Note to Employer: the following metrics may be amended to reflect the specifics of the Contract. The Employer shall ensure that the metrics provided are appropriate for the Works and impacts/key issues identified in the environmental and social assessment]

Metrics for regular reporting:

- a. *environmental incidents or non-compliances with contract requirements, including contamination, pollution or damage to ground or water supplies;*
- b. *health and safety incidents, accidents, injuries that require treatment and all fatalities;*
- c. *interactions with regulators: identify agency, dates, subjects, outcomes (report the negative if none);*
- d. *status of all permits and agreements:*
 - i. *work permits: number required, number received, actions taken for those not received;*
 - ii. *status of permits and consents:*
 - *list areas/facilities with permits required (quarries, asphalt & batch plants), dates of application, dates issued (actions to follow up if not issued), dates submitted to resident engineer (or equivalent), status of area (waiting for permits, working, abandoned without reclamation, decommissioning plan being implemented, etc.);*
 - *list areas with landowner agreements required (borrow and spoil areas, camp sites), dates of agreements, dates submitted to resident engineer (or equivalent);*
 - *identify major activities undertaken in each area in the reporting period and highlights of environmental and social protection (land clearing, boundary marking, topsoil salvage, traffic management, decommissioning planning, decommissioning implementation);*
 - *for quarries: status of relocation and compensation (completed, or details of activities and current status in the reporting period).*
- e. *health and safety supervision:*
 - i. *safety officer: number days worked, number of full inspections & partial inspections, reports to construction/project management;*

-
- ii. number of workers, work hours, metric of PPE use (percentage of workers with full personal protection equipment (PPE), partial, etc.), worker violations observed (by type of violation, PPE or otherwise), warnings given, repeat warnings given, follow-up actions taken (if any);
- f. *worker accommodations:*
- i. number of expats housed in accommodations, number of locals;
 - ii. date of last inspection, and highlights of inspection including status of accommodations' compliance with national and local law and good practice, including sanitation, space, etc.;
 - iii. actions taken to recommend/require improved conditions, or to improve conditions.
- g. *Health services: provider of health services, information and/or training, location of clinic, number of non-safety disease or illness treatments and diagnoses (no names to be provided);*
- h. *gender (for expats and locals separately): number of female workers, percentage of workforce, gender issues raised and dealt with (cross-reference grievances or other sections as needed);*
- i. *training:*
- i. number of new workers, number receiving induction training, dates of induction training;
 - ii. number and dates of toolbox talks, number of workers receiving Occupational Health and Safety (OHS), environmental and social training;
 - iii. number and dates of communicable diseases (including STDs) sensitization and/or training, no. workers receiving training (in the reporting period and in the past); same questions for gender sensitization, flag person training.
 - iv. number and date of SEA and SH prevention sensitization and/or training events, including number of workers receiving training on Code of Conduct for Contractor's Personnel (in the reporting period and in the past), etc.
- j. *environmental and social supervision:*
- i. environmentalist: days worked, areas inspected and numbers of inspections of each (road section, work camp, accommodations, quarries, borrow areas, spoil areas, swamps, forest crossings, etc.), highlights of activities/findings (including violations of environmental and/or social best practices, actions taken), reports to environmental and/or social specialist/construction/site management;
 - ii. sociologist: days worked, number of partial and full site inspections (by area: road section, work camp, accommodations, quarries, borrow areas, spoil areas, clinic, HIV/AIDS center, community centers, etc.), highlights of activities

- (including violations of environmental and/or social requirements observed, actions taken), reports to environmental and/or social specialist/construction/site management; and
- iii. community liaison person(s): days worked (hours community center open), number of people met, highlights of activities (issues raised, etc.), reports to environmental and/or social specialist /construction/site management.
- k. *Grievances*: list new grievances (e.g. number of allegations of SEA and SH) received in the reporting period and number of unresolved past grievances by date received, complainant's age and sex, how received, to whom referred to for action, resolution and date (if completed), data resolution reported to complainant, any required follow-up (Cross-reference other sections as needed):
- i. Worker grievances;
 - ii. Community grievances
- l. *Traffic, road safety and vehicles/equipment*:
- i. traffic and road safety incidents and accidents involving project vehicles & equipment: provide date, location, damage, cause, follow-up;
 - ii. traffic and road safety incidents and accidents involving non-project vehicles or property (also reported under immediate metrics): provide date, location, damage, cause, follow-up;
 - iii. overall condition of vehicles/equipment (subjective judgment by environmentalist); non-routine repairs and maintenance needed to improve safety and/or environmental performance (to control smoke, etc.).
- m. *Environmental mitigations and issues (what has been done)*:
- i. dust: number of working bowsers, number of waterings/day, number of complaints, warnings given by environmentalist, actions taken to resolve; highlights of quarry dust control (covers, sprays, operational status); % of rock/spoil lorries with covers, actions taken for uncovered vehicles;
 - ii. erosion control: controls implemented by location, status of water crossings, environmentalist inspections and results, actions taken to resolve issues, emergency repairs needed to control erosion/sedimentation;
 - iii. quarries, borrow areas, spoil areas, asphalt plants, batch plants: identify major activities undertaken in the reporting period at each, and highlights of environmental and social protection: land clearing, boundary marking, topsoil salvage, traffic management, decommissioning planning, decommissioning implementation;
 - iv. blasting: number of blasts (and locations), status of implementation of blasting plan (including notices, evacuations, etc.), incidents of off-site damage or complaints (cross-reference other sections as needed);

-
- v. spill clean-ups, if any: material spilled, location, amount, actions taken, material disposal (report all spills that result in water or soil contamination);
 - vi. waste management: types and quantities generated and managed, including amount taken offsite (and by whom) or reused/recycled/disposed on-site;
 - vii. details of tree plantings and other mitigations required undertaken in the reporting period;
 - viii. details of water and swamp protection mitigations required undertaken in the reporting period.

n. compliance:

- i. compliance status for conditions of all relevant consents/permits, for the Work, including quarries, etc.): statement of compliance or listing of issues and actions taken (or to be taken) to reach compliance;
- ii. compliance status of C-ESMP/ESIP requirements: statement of compliance or listing of issues and actions taken (or to be taken) to reach compliance
- iii. compliance status of SEA and SH prevention and response action plan: statement of compliance or listing of issues and actions taken (or to be taken) to reach compliance
- iv. compliance status of Health and Safety Management Plan re: statement of compliance or listing of issues and actions taken (or to be taken) to reach compliance

other unresolved issues from previous reporting periods related to environmental and social: continued violations, continued failure of equipment, continued lack of vehicle covers, spills not dealt with, continued compensation or blasting issues, etc. Cross-reference other sections as needed.

Section IX -Particular Conditions of Contract

A. General													
GCC 1.1 (d)	The financing institution is: The World Bank												
GCC 1.1 (r)	The Employer is <i>Executive Engineer, Udupi Division. RDWSD</i>												
GCC 1.1 (v)	<p>The Intended Completion Date for the whole of the Works shall be 11 months (including monsoon) <i>from the date of issue of Notice to proceed.</i></p> <table border="1" style="width: 100%; border-collapse: collapse;"> <thead> <tr> <th style="text-align: center;">Miles tone per Lot</th> <th style="text-align: center;">Description</th> <th style="text-align: center;">Period of Completion from the Issue of Notice to Proceed</th> </tr> </thead> <tbody> <tr> <td style="text-align: center;">1</td> <td>Value of work to be completed 30% of the contract amount</td> <td style="text-align: center;">4 months</td> </tr> <tr> <td style="text-align: center;">2</td> <td>Value of work to be completed 60% of the contract amount</td> <td style="text-align: center;">8months</td> </tr> <tr> <td style="text-align: center;">3</td> <td>Completionofcontractinallrespects</td> <td style="text-align: center;">11months</td> </tr> </tbody> </table>	Miles tone per Lot	Description	Period of Completion from the Issue of Notice to Proceed	1	Value of work to be completed 30% of the contract amount	4 months	2	Value of work to be completed 60% of the contract amount	8months	3	Completionofcontractinallrespects	11months
Miles tone per Lot	Description	Period of Completion from the Issue of Notice to Proceed											
1	Value of work to be completed 30% of the contract amount	4 months											
2	Value of work to be completed 60% of the contract amount	8months											
3	Completionofcontractinallrespects	11months											
GCC 1.1 (y)	<p>The Project Manager is <i>Mr.Surendranath M V, Assistant Executive Engineer, KarkalaSubdivision, RDWSD, Udupi District.</i></p> <p><i>Email: aeerdwsdkrkl@gmail.com</i></p>												
GCC 1.1 (aa)	<i>The Site is located at Survey No. 350 (Latitude 13.464382degree N Longitude: 74.997619degrees E) at HebriGramapanchayat, HebriTaluk, Udupi District, Karnataka, India.</i>												
GCC 1.1 (dd)	The Start Date shall be one week after the date of issue of notice to proceed with works to the contractor.												
GCC 1.1 (hh)	<p>The works consist of <i>construction of civil works for Material Recovery Facility upgradationfrom 5TPD to 7 TPD for dry and plastic waste collected from SwachhSankerna, worn fishing gears collected from local community, and waste collected using trash barriers installed at Storm Water drains and streams.</i></p> <p><i>Identification number of Contract isRWSSD/2024-25/BD/WORK_INDENT8677</i></p>												
GCC 1.1 (jj)	<p>GCC 1.1 (jj) is replaced with the following:</p> <p>“Key Personnel are the Contractor’s personnel named in GCC 9.1 of the Particular Conditions of Contract.”</p>												

GCC 2.2	Sectional Completions are: Not appropriate		
GCC 2.3(i)	The following documents also form part of the Contract:		
	S. No.	Document	Description of the document
	1.	Construction Methodology	Construction methodology given in bid amended as per comments of employer given in letter of acceptance.
	2.	Quality control	Quality control procedures and assurance plans given in the bid and amended as per comments of Employer given in letter of acceptance.
	3.	Fraud and Corruption	Appendix A – Fraud and Corruption
	4.	Environmental and Social	Appendix B - Environmental and Social (ES) Metrics for Progress Reports.
5.	JV Agreement	Joint Venture Agreement (for JVs only).	
GCC 3.1	<p>The following is inserted as a sub-clause at the end of GCC 3.1:</p> <p>“Salient features of major labour and other laws that are applicable to construction industry in India/Karnataka State are given as Appendix 2 to these General Conditions of Contract.”</p> <p>The language of the contract is <i>English</i>.</p> <p>The law that applies to the Contract are the laws of Union of India.</p>		
GCC 4.1	<p>The following is inserted as a sub-paragraph at the end of GCC 4.1:</p> <p>“However, if the Project Manager is required, under the rules and regulations and orders of the Employer, to obtain approval of some other authorities for specific actions, he will so obtain the approval. Provided further that any requisite approval shall be deemed to have been given by the Employer for any such authority exercised by the Project Manager.”</p>		
GCC 5.1	The Project manager <i>may</i> delegate any of his duties and responsibilities.		
GCC 6.1	<p>The following is inserted at the end of GCC 6.1:</p> <p>“All oral instructions shall be confirmed in writing in seven working days.”</p>		
GCC 7	<p>The first sentence of GCC 7. 1 is modified as:</p> <p>“The Contractor may subcontract with the approval of the Project Manager up to a ceiling specified in PCC, but may not assign the Contract without the approval of the Employer in writing.”</p>		

	<p>The following sub-clauses are inserted at the end of GCC 7.1:</p> <p>“7.2 The Project Manager should satisfy himself before recommending to the Employer whether:</p> <ul style="list-style-type: none"> a) the circumstances warrant such sub-contracting; and, b) the sub-Contractor so proposed for the Work possesses the experience, qualifications and equipment necessary for the job proposed to be entrusted to him in proportion to the quantum of Works to be sub-contracted. <p>7.3 If payments are proposed to be made directly to that sub-contractor, this should be subject to specific authorization by the prime contractor so that his arrangement does not alter the contractor’s liability or obligations under the contract.</p> <p>7.4 The Contractor shall not be required to obtain any consent from the Employer for:</p> <ul style="list-style-type: none"> (a) the sub-contracting of any part of the Works for which the Sub-Contractor is already named in the contract; (b) the provision for labour, or labour component, and, (c) the purchase of materials which are in accordance with the standards specified in the contract. <p><i>(Note: 1. All bidders are expected to indicate clearly in the bid, if they proposed sub-contracting elements of the works amounting to more than 10 percent of the Bid Price. For each such proposal the qualification and the experience of the identified sub-contractor in the relevant field should be furnished along with the bid to enable the employer to satisfy himself about their qualifications before agreeing for such sub-contracting and include it in the contract. In view of the above, normally no additional sub-contracting should arise during execution of the contract.</i></p> <p><i>2. However, [a] sub-contracting for certain specialized elements of the work is not unusual and acceptable for carrying out the works more effectively; but vertical splitting of the works for sub-contracting is not acceptable. [b] In any case, proposal for sub-contracting in addition to what was specified in bid and stated in contract agreement will not be acceptable if the value of such additional sub-contracting exceeds 25% of value of work which was to be executed by Contractor without sub-contracting.</i></p> <p><i>3. Assignment of the contract may be acceptable only under exceptional circumstances such as insolvencies/liquidation or merger of companies etc.)”</i></p>
GCC 7.1	The ceiling for sub-contractor is 5% [<i>This is in addition to what was stated in bid and incorporated in contract agreement.</i>]. Hiding information about any sub-contracting not authorized by the Employer shall be treated as violation of Appendix A to General Conditions (Fraud and Corruption).
GCC 8.1	Schedule of other contractors: <i>NA</i>

OGCC 9	<p>The following is inserted as a sub-clause at the end of GCC 9.2:</p> <p>“In all the above cases, the contractor shall ensure that the person leaves the site within seven days and has no further connection with the work in the contract. The Contractor shall appoint a suitable replacement within 28 days or earlier as may be agreed to between the Project Manager and the Contractor.”</p> <p>The following sentence is deleted from first paragraph of GCC 9.4.1:</p> <p>“The Contractor is encouraged, to the extent practicable and reasonable, to employ staff and labor with appropriate qualifications and experience from sources within the Country.”</p> <p>GCC 9.4.3 and GCC 9.4.4 are deleted.</p> <p>The following sub-clauses are inserted at the end of GCC 9.4:</p> <p>“9.5 The Contractor shall not employ any retired Gazetted officer who has either not completed two years after the date of retirement or has not obtained permission from the Government authorities for employment with the Contractor¹².</p> <p>9.6 During continuance of the Contract, the Contractor and his Sub-Contractors shall abide at all times by all existing labour enactments and rules made there under, regulations, notifications and bye laws of the State or Central Government or local authority and any other labour laws (including rules), regulations, bye laws that may be passed or notification that may be issued under any labour law prevailing on the Base Date either by the State or the Central Government or the local authority. The Contractor shall keep the Employer indemnified in case any action is taken against the Employer by the competent authority on account of contraventions including amendments. If the Employer is caused to pay or reimburse, such amounts as may be necessary to cause or observe, or for non-observance of the provisions stipulated in the notifications/bye laws/Acts/Rules/regulations including amendments, if any, on the part of the Contractor, the Project Manager/ Employer shall have the right to deduct any money due to the Contractor including his amount of performance security and if applicable, the Environmental and Social (ES) Performance Security. The Employer/ Project Manager shall also have right to recover from the Contractor any sum required or estimated to be required for making good the loss or damage suffered by the Employer.</p> <p>9.7 The employees of the Contractor and the Sub-Contractor in no case shall be treated as the employees of the Employer at any point of time.</p> <p>9.8 The Contractor shall duly comply with the provisions of the Apprentices Act 1961 (III of 1961) and the rules made there under, and comply,</p>
---------------	--

¹²Based on Government Directives.

	failure or neglect to shall be subject to all liabilities and penalties provided in the said Act and Rules.”																								
GCC 9.1	<i>[insert the name/s of each Key Personnel agreed by the Employer prior to Contract signature, Schedule of Key Personnel and equipment as indicated in accepted bid & construction methodology]. To be filled during signing of contract</i>																								
GCC 13.1	<p>The minimum insurance amounts and deductibles shall be:</p> <table border="1"> <thead> <tr> <th>S.No.</th> <th>Description</th> <th>Minimum cover for Insurance</th> <th>Maximum deductible for Insurance</th> </tr> </thead> <tbody> <tr> <td>(i)</td> <td>Works and Plant and Materials</td> <td>InitialContractValue</td> <td>5% ofthecontract value</td> </tr> <tr> <td>(ii)</td> <td>Loss or damage to Equipment</td> <td>Totalbook value of the equipment broughttothe site by the contractor</td> <td>5% ofbook value</td> </tr> <tr> <td>(iii)</td> <td>Other Property (except the Works, Plant, Materials, and Equipment)</td> <td>For each Lot INR50 Lakhs</td> <td>5% ofproperty value</td> </tr> <tr> <td>(iv)</td> <td>Personal injury or death insurance: a) for other people;</td> <td>As per workmen’s compensation Act 1923 and other Acts in force</td> <td>As per workmen’s compensation Act 1923andotherActs in force</td> </tr> <tr> <td></td> <td>b) for Contractor’s Employees</td> <td>Inaccordancewiththestatutoryrequirements applicableinIndia</td> <td></td> </tr> </tbody> </table>	S.No.	Description	Minimum cover for Insurance	Maximum deductible for Insurance	(i)	Works and Plant and Materials	InitialContractValue	5% ofthecontract value	(ii)	Loss or damage to Equipment	Totalbook value of the equipment broughttothe site by the contractor	5% ofbook value	(iii)	Other Property (except the Works, Plant, Materials, and Equipment)	For each Lot INR50 Lakhs	5% ofproperty value	(iv)	Personal injury or death insurance: a) for other people;	As per workmen’s compensation Act 1923 and other Acts in force	As per workmen’s compensation Act 1923andotherActs in force		b) for Contractor’s Employees	Inaccordancewiththestatutoryrequirements applicableinIndia	
S.No.	Description	Minimum cover for Insurance	Maximum deductible for Insurance																						
(i)	Works and Plant and Materials	InitialContractValue	5% ofthecontract value																						
(ii)	Loss or damage to Equipment	Totalbook value of the equipment broughttothe site by the contractor	5% ofbook value																						
(iii)	Other Property (except the Works, Plant, Materials, and Equipment)	For each Lot INR50 Lakhs	5% ofproperty value																						
(iv)	Personal injury or death insurance: a) for other people;	As per workmen’s compensation Act 1923 and other Acts in force	As per workmen’s compensation Act 1923andotherActs in force																						
	b) for Contractor’s Employees	Inaccordancewiththestatutoryrequirements applicableinIndia																							
GCC 14.1	Site Data are: <i>at the Office of Executive Engineer, Udupi Division, Udupi, Karnataka.</i>																								
GCC 15.1	<p>GCC 15.1 is replaced with the following:</p> <p>“The Contractor shall construct and install the Works in accordance with the Specifications and Drawings and as per instructions of Project Manager.”</p>																								
GCC 18 (add new 18.3.3)	<p>The following is inserted as a new sub-clause 18.3.3:</p> <p>“18.3.3 During continuance of the contract, the contractor and his sub-contractors shall abide at all times by all existing enactments on environmental protection and rules made thereunder, regulations, notifications and by-laws of the State or Central Government, or local authorities and other law, bye-law, regulations that may be passed or notification that may be issued in this respect in future by the State or Central Government or the local authority. Salient features of the</p>																								

	<p>major laws are given in Appendix 1 to the General Conditions of Contract.</p> <p>The Contractor shall submit, to the Project manager for Review any additional MSIPs as are necessary to manage the ES risks and impacts of ongoing Works (e.g. excavation, earth works, bridge and structure works, stream and road diversions, quarrying or extraction of materials, concrete batching and asphalt manufacture). These MSIPs collectively comprise the Contractor’s Environmental and Social Management Plan (C-ESMP). The Contractor shall review the C-ESMP, periodically (but not less than every six (6) months), and update it as required to ensure that it contains measures appropriate to the Works. The updated C-ESMP shall be submitted to the Project manager for Review.”</p>
GCC 20.1	The Site Possession Dates shall be mentioned in Notice to Proceed
GCC 23	<p>The following is inserted as a new sub-clause 23.1.1:</p> <p>“23.1.1 The Adjudicator should be in position before “notice to proceed with work” is issued to the Contractor and an agreement should be signed with the Adjudicator jointly by the Employer and the Contractor in the form attached – Appendix 3.”</p>
GCC 23.1 & GCC 23.2	<p>Name of the agreed Adjudicator <i>Shri C Gopinatha Rao</i></p> <p><i>(insert name before signing contract in agreement with the Employer and Contractor)</i></p> <p>Appointing Authority for the Adjudicator: <i>Executive Engineer, RDWSD, Udupi Division</i></p>
GCC 24	In the first sentence in GCC 24.3, the words “The Adjudicator shall be paid by the hour at the rate” are replaced by the words “The Adjudicator shall be paid daily at the rate”
GCC 24.3	Daily rate and types of reimbursable expenses to be paid to the Adjudicator: <i>Rs. 10,000 per day, and reimbursable expenses – boarding/ lodging/ travel etc., as per the daily fee and reimbursable expenses payable to the Adjudicator will be governed by rules of the Institution of Engineers (Bengaluru Chapter).</i>
GCC 24.4	<p>The procedure for adhoc arbitration will be as follows:</p> <p>(a) In case of Dispute or difference arising between the Employer and a Contractor relating to any matter arising out of or connected with this agreement, such disputes or difference shall be settled in accordance with the Arbitration and Conciliation Act, 1996. The arbitral tribunal shall consist of 3 Arbitrators one each to be appointed by the Employer and the Contractor. The third Arbitrator shall be chosen by the two Arbitrators so appointed by the Parties and shall act as Presiding Arbitrator. In case of failure of the two</p>

	<p>Arbitrators appointed by the parties to reach upon a consensus within a period of 30 days from the appointment of the Arbitrator appointed subsequently, the Presiding Arbitrator shall be appointed by the* Indian Council of Arbitration/President of the Institution of Engineers (Bengaluru Chapter)/International Center of Bengaluru or Alternative Dispute Resolution of India.</p> <p>(b) If one of the parties fails to appoint its Arbitrator in pursuance of sub-clause (a) above within 30 days after receipt of the notice of the appointment of its Arbitrator by the other party, then the *Indian Council of Arbitration/President of the Institution of Engineers (India) both in cases of Foreign Contractor as well as Indian Contractor, shall appoint the Arbitrator. A certified copy of the order of the*Indian Council of Arbitration/President of the Institution of Engineers (Bengaluru Chapter)/International Center of Bengaluru or Alternative Dispute Resolution of India, making such an appointment shall be furnished to each of the parties.</p> <p>(c) Arbitration may be commenced prior to or after completion of the Works, provided that the obligations of the Employer, the Project Manager, the Contractor and the Adjudicator shall not be altered by reason of the arbitration being conducted during the progress of the Works.</p> <p>(d) Arbitration proceedings shall be held at Udupi, Udupi District, Karnataka, India, and the language of the arbitration proceedings and that of all documents and communications between the parties shall be English.</p> <p>(e) The decision of the majority of Arbitrators shall be final and binding upon both parties. The cost and expenses of Arbitration proceedings will be paid as determined by the arbitral tribunal. However, the expenses incurred by each party in connection with the preparation, presentation, etc. of its proceedings as also the fees and expenses paid to the Arbitrator appointed by such party or on its behalf shall be borne by each party itself.</p> <p>(f) Where the value of the contract is Rs. 50 million and below, the disputes or differences arising shall be referred to the Sole Arbitrator. The Sole Arbitrator should be appointed by agreement between the parties; failing such agreement, by the appointing authority, namely the * Indian Council of Arbitration/President of the Institution of Engineers (Bengaluru Chapter)/International Center of Bengaluru or Alternative Dispute Resolution of India.</p> <p>(g) The Arbitrator should give final award within 180 days of starting of the proceedings.</p> <p>(h) Performance under the contract shall continue during the arbitration proceedings and payments due to the contractor by the Employer shall not be withheld, unless they are the subject matter of the</p>
--	---

	<p>arbitration proceedings.</p> <p>* Any dispute or difference whatsoever arising between the parties out of or relating to the construction, meaning, scope, operation or effect of this contract or the validity or the breach thereof shall be settled by arbitration in accordance with the Rules of Domestic Commercial Arbitration of the Indian Council of Arbitration and the award made in pursuance thereof shall be binding on the parties.</p> <p>"Any dispute or difference whatsoever arising between the parties out of or relating to the construction, meaning, scope, operation or effect of this contract or the validity or the breach thereof shall be settled by arbitration in accordance with the Rules of Domestic Commercial Arbitration of the Indian Council of Arbitration and the award made in pursuance thereof shall be binding on the parties.</p> <p>The arbitral tribunal shall consist of 3 Arbitrators, arbitration proceedings shall be held at Udupi, Karnataka, India and the language of the arbitration proceedings and that of all documents and communications between the parties shall be English". <i>[ICA rules provide for arbitration tribunal of 3 arbitrators if the value of claim is over Rs. 1 crore unless the parties have agreed otherwise for a sole arbitrator].</i></p>
<p>B. Time Control</p>	
<p>GCC 30.1</p>	<p>The Contractor shall submit for approval a Program for the Works within 14 days of delivery of the Letter of Acceptance.</p> <p>Any revision in Program should only be agreed in writing.</p> <p><i>[This program should be in adequate detail and generally conform to the program submitted along with bid. Deviations, if any from that should be clearly explained and should be satisfactory to the Project Manager]</i></p>
<p>GCC 30.3</p>	<p>The period between Program updates is 60 days.</p> <p>The amount to be withheld for late submission of an updated Program is 1,00,000.00.</p> <p>The period for submission of progress reports is 30 days.</p>
<p>GCC 31</p>	<p>GCC 31.1 is replaced with the following:</p> <p>“31.1 The Project Manager shall extend the Intended Completion Date including milestones if a Compensation Event occurs or a Variation is issued which makes it impossible for Completion to be achieved by the Intended Completion Date as per the agreed milestones without the Contractor taking steps to accelerate the remaining work, which would cause the Contractor to incur additional cost.”</p> <p>In GCC 31.2, replace the words “Intended Completion Date” at the first occurrence by the words “Intended Completion Date/ Milestones”;</p>

	and at the second occurrence by the words “Intended Completion Date/ Milestone”.
GCC 34	GCC 34.1 is replaced with the following: “Either the Project Manager or the Contractor may require the other to attend a management meeting (which will be held at the place indicated in PCC . The periodicity shall be fixed by Project Manager/ Contractor jointly). The business of a management meeting shall be to review the progress of construction with reference to the construction program given in accordance with GCC 30.1, the plans for remaining work and to deal with matters raised in accordance with the early warning procedure.”
GCC 34.1	Venue of management meeting will be O/o Executive Engineer, Udupi division, RDWSD, Udupi, Karnataka, India. The management meetings shall be held at intervals of 30 days.
C. Quality Control	
GCC 36	The following sub-clause is inserted at the end of GCC 36.1: “36.2 The contractor shall permit the Employer’s Technical auditor to check the contractor’s work and notify the Project Manager and Contractor of any defects that are found. Such a check shall not affect the Contractor’s or the Project Manager’s responsibility as defined in the Contract Agreement.”
GCC 37	The following sub-clauses are inserted before GCC 37.1, and GCC 37.1 is re-numbered as GCC 37.3: “GCC 37.1 The Contractor shall institute Quality Assurance (QA) and Quality Control (QC) systems in accordance with Quality Assurance Plan to demonstrate compliance with the requirements of the Contract as approved by the Project Manager. Compliance with the QA/QC systems shall not relieve the Contractor of any of his duties obligations or responsibilities under the Contract. GCC 37.2 The Contractor shall provide all apparatus, assistance, documents and other information, electricity, equipment, fuel, consumables, instruments, labour, materials, and suitably qualified and experienced staff, as are necessary to carry out the specified tests efficiently.”
GCC 38.1	The Defects Liability Period is: 365 days.
GCC 39.1	The following notes are added at the end of GCC 39.1: <i>“Note: 1. Where in certain cases, the technical specifications provide for acceptance of works within specified tolerance limits at reduced rates,</i>

	<p><i>Project Manager will certify payments to Contractor accordingly.</i></p> <p><i>2. Where the failure to correct a particular defect within the specified time is considered as a fundamental breach of contract a notice should be given to the contractor as stated in GCC 61.2(e)."</i></p>
D. Cost Control	
GCC 41	<p>GCC 41.1 is replaced with the following, and existing GCC 41.2 is re-numbered as GCC 41.3:</p> <p>"41.1 If the final quantity of the work done differs from the quantity in the Bill of Quantities for the particular item by more than 25 percent, provided the change exceeds 1 percent of the Initial Contract Price, the Project Manager shall adjust the rate to allow for the change.</p> <p>(a) If the quantity of work executed exceeds the quantity of the item in BOQ beyond the higher specified limit the Project Manager shall fix the rate to be applied for the additional quantity of the work executed.</p> <p>(b) If the quantity of work executed is less than the quantity of the item in BOQ and is lesser than the lower specified limit, the Project Manager shall fix the rate to be applied for whole of the quantity of the work so executed</p> <p>41.2 The Project Manager shall not adjust rates from changes in quantities if thereby the Initial Contract Price is exceeded by more than 15 percent, except with the prior approval of the Employer."</p>
GCC 42	<p>In GCC 42.2, the first sentence is modified as follows:</p> <p>"The Contractor shall provide the Project Manager with a quotation (with breakdown of unit rates) for carrying out the Variation when requested to do so by the Project Manager. The Contractor shall also provide a description of the varied work performed or to be performed, including details of the resources and methods adopted or to be adopted by the Contractor."</p> <p>In the first sentence in GCC 42.3, after the words 'If the Contractor's quotation is unreasonable', the following is added:</p> <p>"[or if contractor fails to provide the Project Manager with a quotation within a reasonable time specified by Project Manager in accordance with GCC 42.2]"</p>
GCC 42.7	Provisions related to Value Engineering do not apply.
GCC 43.1	<p>The second sentence in GCC 43.1 is replaced with the following:</p> <p>"The cash flow forecast shall be in Indian Rupees."</p>
GCC 44	At the end of GCC 44.1 after the word 'previously', the following words are

	<p>added:</p> <p>“alongwith details of measurement of the quantity of works executed in a tabular form approved by the Project Manager”</p> <p>At the end of GCC 44.2 after the words ‘the Contractor’, the following words are added:</p> <p>“after taking into account any credit or debit for the month in question in respect of materials for the works in the relevant amount and under conditions set forth in GCC Sub-Clause 53.1 (Secured Advance)”</p>
GCC 45	<p>GCC 45.1 is replaced with the following:</p> <p>“Payments shall be adjusted for deductions for advance payments, retention, other recoveries in terms of contract & taxes to be deducted at source [TDS] as per applicable law. The Employer shall pay the Contractor the amounts certified by the Project Manager within 60 days of the date of each certificate. If the Employer makes a late payment, the Contractor shall be paid interest on the late payment in the next payment. Interest shall be calculated from the date by which the payment should have been made up to the date when the late payment is made at the rate stated in the PCC.”</p> <p>A new sub-clause 45.5 is added after sub-clause 45.4:</p> <p>“45.5 The Contractor shall open an Escrow Account with his bank for the purpose of receiving all the payments as well as incurring expenditure under this Contract. The Account shall be open to verification and audit at any time by the Employer or designee of the Employer. This account will be controlled solely by the Contractor’s Project Officers (Project Manager and/or Finance Manager or equivalent designate). No other Contractor employees or associates will have access to the Project Account or the funds therein. The Contractor shall report monthly on the status of this account including actual bank account statements. The Contractor shall provide all Account statements as requested by the Employer.”</p>
GCC 45.1	Interest rate for Delayed payment is 15% per annum.
GCC 45.3	All payments (and deductions) shall be paid or charged in Indian Rupees.
GCC 45.5	Deleted
GCC 47	<p>The following sub-clause is inserted before GCC 47.1, and GCC 47.1 is renumbered</p> <p>as GCC 47.2:</p> <p>“47.1 The rates quoted by the Contractor shall be deemed to be Inclusive of the GST and other taxes that the Contractor will have to pay for the performance of this Contract. The Employer will perform such duties in regard to the deduction of such taxes at source [TDS] as per applicable law.”</p> <p>In first line of the re-numbered GCC 47.2, replace the words ‘the date 28 days before’ with the words ‘the deadline for’. The first line of 47.1, replace</p>

	the words "Inclusive of the" with the words "Exclusive of GST,"
GCC 48	All payments shall be made in Indian Rupees.
GCC 49	<p>GCC 49.1 is replaced with the following:</p> <p>“Contract price shall be adjusted for increase or decrease in rates and price of labour, materials, fuels and lubricants and other inputs to the works in accordance with the principles and procedures outlined below. A table of adjustment data is included in the PCC which indicates the coefficients of various inputs and the sources of indices for various schedules of BOQ. If the PCC does not include a table of adjustment data this sub clause shall not apply and there shall be no price adjustment.</p> <p>(a) The price adjustment according to sub para (d) below, shall apply for the work done from the start date given in the PCC up to the end of the Intended Completion Date. If there is delay in completion beyond such date for reasons attributable to the contractor, the Price Adjustment for the work carried out during such period, for reasons attributable to the Contractor, shall be regulated by sub-para (g) below.</p> <p>(b) The Contract Price shall be adjusted to take account of any increase or decrease in cost after the base date, which affect the Contractor in performance of obligations under the Contract.</p> <p>(c) The total value (R) of the work done during the specified period [GCC 44.1] shall be as under:</p> $R = \text{SUM} (R_{S1} + R_{S2} + R_{S3} + \dots R_{Sn}),$ <p>Where,</p> <p>‘R_{sn}’ is the value of work done during the specified period to which the price adjustment shall be applied for the relevant schedule of Bill of Quantities (BOQ) specified in P.C.C during the specified period, and represented as under:</p> <p>R_{sn} = (V_{sn} + S_{sn}) minus (amount of secured advance recovered in the same period + value of works executed under variations for which price adjustments will be worked separately based on terms mutually agreed between the Project Manager and the Contractor)</p> <p>where,</p> <p>V_{sn} is the total value of work done during the specified period for the respective schedule of BOQ, and</p> <p>S_{sn} is the secured advance paid during the specified period for the respective schedule of BOQ,</p>

- (d) The adjustment to be applied to the amount otherwise payable to the Contractor, as valued in accordance with the appropriate schedule of BOQ and certified in Payment Certificates, shall be determined from formulae which shall be of the following general type:

$$P_n = a + b L_n/L_o + c E_n/E_o + d M_n/M_o + \dots\dots\dots$$

where,

“P_n” is the adjustment multiplier to be applied to the value of the work done during the period “n”, this period being a month unless otherwise stated in the PCC.

“a” is a fixed coefficient, stated in the relevant table of adjustment data, representing the non-adjustable portion in contractual payments;

“b”, “c”, “d”,... are coefficients representing the estimated proportion of each cost element related to the execution of the Works, as stated in the relevant table of adjustment data; such tabulated cost elements may be indicative of resources such as labour, equipment and materials;

“L_n”[*Labour*], “E_n”[*Equipment*], “M_n”[*Material*], are the current cost indices or reference prices for period “n”, each of which is applicable to the relevant tabulated cost element [*Labour, Equipment, Steel, Cement, Fuel/Lubricants, Bitumen, others*] on the date, specified in the Table-2 of Adjustment Data, prior to the last day of the period (to which the particular Payment Certificate relates); and

“L_o”, “E_o”, “M_o”,are the base cost indices or reference prices, expressed in the relevant currency of payment, each of which is applicable to the relevant tabulated cost element on the Base Date.

- (e) The cost indices or reference prices stated in the tables of adjustment data given in PCC shall be used. The base date shall be the deadline for submission of bids.
- (f) If the Contractor fails to complete the Works within the Intended Completion date, adjustment of prices thereafter shall be made using either:
- (i) index or price applicable for each cost element tabulated in the tables of adjustment data on the specified date prior to the expiry of the Intended Completion Date, or
 - (ii) the current index or price applicable for the period in question whichever is more favourable to the Employer.
- (g) The weightings (coefficients) for each of the factors of cost stated

	<p>in the table(s) of adjustment data shall only be varied by the Project Manager if they have been rendered unreasonable, unbalanced or inapplicable, as a result of Variations.</p> <p>(h) Unless otherwise stated in the P.C.C., the Price adjustment shall be done in each monthly Interim Payment Certificate [IPC]. The coefficients and indices are given in the Tables of Adjustment Data in Contract data.</p> <p>To the extent that full compensation for any rise or fall in costs to the contractor is not covered by the provisions of this or other clauses in the contract, the unit rates and prices included in the contract shall be deemed to include amounts to cover the contingency of such other rise or fall in costs.”</p>
GCC 49.1	Price Adjustment: Not applicable
GCC 50.1	The proportion of payments retained (Retention Money) shall be 5% from each bill subject to the maximum of 5% of final contract price.
GCC 50.2	<p>The last line of GCC 50.2 is replaced with the following:</p> <p>“On completion of the whole works the Contractor may substitute the balance retention money with an “on demand” Bank guarantee.”</p>
GCC 51	<p>In the first sentence of GCC 51.1, the following words are inserted after the words ‘Intended Completion Date’:</p> <p>“(for the whole of the works or the milestones as stated in the PCC)”</p> <p>The following is inserted as a sub-paragraph at the end of GCC 51.1:</p> <p>“Time is the essence of the contract and payment or deduction of liquidated damages shall not relieve the contractor from his obligation to complete the work as per agreed construction program and milestones, or from any of the Contractor’s other obligations and liabilities under the contract.”</p> <p>In the first sentence in GCC 51.2 the following words are inserted after the words ‘Intended Completion Date’:</p> <p>“including milestones”</p>
GCC 51.1	The liquidated damages for the whole of the Works are 0.05% per day. The maximum amount of liquidated damages for the whole of the Works is 10% of the final Contract Price.
GCC 52.1	Not Applicable
GCC 53	<p>The following is inserted as a new sub-clause 53.4:</p> <p>“The Project Manager shall make advance payment in respect of materials intended for but not yet incorporated in the Works in accordance with conditions stipulated in the PCC.”</p>

<p>GCC 53.1</p>	<p>Advance Payments shall be made in Indian Rupees only. The amount of the Advance Payments are as briefed below.</p> <table border="1" data-bbox="414 289 1364 619"> <thead> <tr> <th data-bbox="414 289 722 346"><u>Nature of Advance</u></th> <th data-bbox="730 289 1031 346"><u>Amount (Rs.)</u></th> <th data-bbox="1039 289 1364 346"><u>Conditions to be fulfilled</u></th> </tr> </thead> <tbody> <tr> <td data-bbox="414 388 722 451">1. Mobilization¹³</td> <td data-bbox="730 388 1031 451">5% of the Contract price</td> <td data-bbox="1039 388 1364 619">On submission of unconditional Bank Guarantee. <i>(to be drawn before end of 20% of Contract period)</i></td> </tr> </tbody> </table> <p>(The advance payment will be paid to the Contractor no later than 15 days after fulfilment of the above conditions).</p>	<u>Nature of Advance</u>	<u>Amount (Rs.)</u>	<u>Conditions to be fulfilled</u>	1. Mobilization ¹³	5% of the Contract price	On submission of unconditional Bank Guarantee. <i>(to be drawn before end of 20% of Contract period)</i>
<u>Nature of Advance</u>	<u>Amount (Rs.)</u>	<u>Conditions to be fulfilled</u>					
1. Mobilization ¹³	5% of the Contract price	On submission of unconditional Bank Guarantee. <i>(to be drawn before end of 20% of Contract period)</i>					
<p>GCC 54</p>	<p>GCC 54.1 is replaced with the following:</p> <p>“The Performance Security and an Environmental and Social (ES) Performance Security shall be provided to the Employer no later than the date specified in the Letter of Acceptance and shall be issued in the amounts specified in the PCC, and shall be issued by a Nationalized or Scheduled bank in India. The Performance Security including additional security for unbalanced bids, and the ES Performance Security, shall be valid until a date 28 days from the date of issue of the Certificate of Completion.”</p>						
<p>GCC 54.1</p>	<p>The Performance Security amount is 5% percent of the Accepted Contract Amount plus additional security for unbalanced bids [<i>in terms of ITB Clause 41.2</i>] would be equivalent amount i.e. less than 10% of the estimated cost, and Environmental and Social (ES) Performance Security amount is 1% of the Accepted Contract Amount</p> <p>The standard forms of Performance Security and if applicable ES Security acceptable to the Employer shall be <u>unconditional</u> Bank Guarantees from Scheduled or Nationalized banks in India of the types as presented in Section X of the Bidding Document.</p> <p>Throughout this bidding document the term ‘performance security’, unless the context clearly indicates otherwise, means and includes both ‘the performance security and the ES performance security’ to be submitted by the successful bidder in the amounts specified above.</p>						
<p>E. Finishing the Contract</p>							
<p>GCC 59.1</p>	<p>The following is added after the words ‘issue a payment certificate’ at the end of GCC 59.1:</p>						

¹³ The amount of mobilization advance could be increased or decreased based on nature of the work. Also, the advance could be released in single or multiple instalments.

	“within 56 days of receiving the contractor’s revised account”
GCC 60.1	<p>The date by which operating and maintenance manuals are required is within 28 days of issue of certificate of completion of whole or section of work, as the case may be, 28 days post completion of works.</p> <p>The date by which “as built” drawings (in scale) including a compact disc containing digitized drawings in 2 sets are required, is within 28 days of issue of certificate of completion of whole or section of the work, as the case may be 11 months (including monsoon) after commencement of works.</p>
GCC 60.2	The amount to be withheld for failing to produce “as built” drawings and/or operating and maintenance manuals by the date required in GCC 60.1 is Rs. 1% of the bid amount.
GCC 61	<p>The following sub-clauses are added after GCC 61.2 (h):</p> <p>“(i) The contractor has contravened Clauses 7 and 9 of GCC.</p> <p>(j) The contractor does not adhere to the agreed construction program, agreed ES-MSIP [Clause 30 of GCC], and also fails to take satisfactory remedial action as per agreements reached in the management meetings [Clause 30 of GCC] for a period of 60 days.</p> <p>(k) The contractor fails to carry out the instructions of the Project Manager within a reasonable time determined by the Project Manager in accordance with GCC Clause 15.1 and 22.</p> <p>(l) The contractor (in case of Joint Venture) has modified the composition of the joint venture and/or the responsibility of each member of the joint venture from what is stated in joint venture agreement without the prior approval of the Employer.”</p>
GCC 61.2 (g)	The maximum number of days is: <i>28days</i> after commencement of works
GCC 61.2(i)	Hiding any information regarding changes in roles and responsibilities of JV members, which is not authorized by the Employer, shall also be treated as violation of Appendix A to General Conditions (Fraud and Corruption).
GCC 62	<p>The following is added after the words ‘issue of the certificate’ in the first sentence of GCC 62.1;</p> <p>“less other recoveries due in terms of contract, less taxes to be deducted at source [TDS] as per applicable law,”</p> <p>The following is added after the words ‘date of the certificate’ at the end of GCC 62.2:</p> <p>“less other recoveries due in terms of contract, less taxes to be deducted at source [TDS] as per applicable law”</p>
GCC 62.1	The percentage to apply to the value of the work not completed, representing

	the Employer's additional cost for completing the Works, is 20%.
--	--

Appendices

Appendix 1

Salient Features of Labour & Environment Protection Laws¹⁴

SALIENT FEATURES OF SOME MAJOR LABOUR LAWS APPLICABLE TO ESTABLISHMENTS ENGAGED IN BUILDING AND OTHER CONSTRUCTION WORK

- (a) Employees Compensation Act 1923: The Act provides for compensation in case of injury, disease or death arising out of and during the course of employment.
- (b) Payment of Gratuity Act 1972: gratuity is payable to an employee under the Act on satisfaction of certain conditions on separation if an employee has completed 5 years' service or more or on death at the rate of 15 days wages for every completed year of service. The Act is applicable to all establishments employing 10 or more employees.
- (c) Employees P.F. and Miscellaneous Provision Act 1952 (since amended): The Act provides for monthly contribution by the employer plus workers @ 10% or 8.33%. The benefits payable under the Act are:
 - (i) Pension or family pension on retirement or death, as the case may be.
 - (ii) Deposit linked insurance on the death in harness of the worker.
 - (iii) Payment of P.F. accumulation on retirement/death etc.
- (d) Maternity Benefit Act 1961: The Act provides for leave and some other benefits to women employees in case of confinement or miscarriage etc.
- (e) Sexual Harassment of Women at the Workplace (Prevention, Prohibition and Redressal) Act, 2013: This Act defines sexual harassment in the workplace, provides for an enquiry procedure in case of complaints and mandates the setting up of an Internal Complaints Committee or a Local Complaints Committee
- (f) Contract Labour (Regulation & Abolition) Act 1970: The Act provides for certain welfare measures to be provided by the Contractor to contract labour and in case the Contractor fails to provide, the same are required to be provided, by the Principal Employer by law. The Principal Employer is required to take Certificate of Registration and the Contractor is required to take license from the designated Officer. The Act is applicable to the establishments or Contractor of Principal Employer if they employ 20 or more contract labour.
- (g) Minimum Wages Act 1948: The Employer is supposed to pay not less than the

¹⁴This list is only illustrative and not exhaustive. Bidders and Contractors are responsible for checking the correctness and completeness of the list. The law as current on the date of bid opening will apply.

Minimum Wages fixed by appropriate Government as per provisions of the Act if the employment is a scheduled employment. Construction of Buildings, Roads, Runways are scheduled employments.

- (h) Payment of Wages Act 1936: It lays down the mode, manner and by what date the wages are to be paid, what deductions can be made from the wages of the workers.
- (i) Equal Remuneration Act 1976: The Act provides for payment of equal wages for work of equal nature to male and female workers and for not making discrimination against Female employees in the matters of transfers, training and promotions etc.
- (j) Payment of Bonus Act 1965: The Act is applicable to all establishments employing 20 or more employees. Some of the State Governments have reduced this requirement from 20 to 10. The Act provides for payments of annual bonus subject to a minimum of 8.33% of the wages drawn in the relevant year. It applies to skilled or unskilled manual, supervisory, managerial, administrative, technical or clerical work for hire or reward to employees who draw a salary of Rs. 10,000/- per month or less. To be eligible for bonus, the employee should have worked in the establishment for not less than 30 working days in the relevant year. The Act does not apply to certain establishments.
- (k) Industrial Disputes Act 1947: the Act lays down the machinery and procedure for resolution of Industrial disputes, in what situations, a strike or lock-out becomes illegal and what are the requirements for laying off or retrenching the employees or closing down the establishment.
- (l) Trade Unions Act 1926: The Act lays down the procedure for registration of trade unions of workmen and employers. The Trade Unions registered under the Act have been given certain immunities from civil and criminal liabilities.
- (m) Child Labour (Prohibition & Regulation) Act 1986: The Act prohibits employment of children below 14 years of age in certain occupations and processes and provides for regulation of employment of children in all other occupations and processes. Employment of Child Labour is prohibited in the Building and Construction Industry.
- (n) Inter-State Migrant workmen's (Regulation of Employment & Conditions of Service) Act 1979: The Act is applicable to an establishment which employs 5 or more inter-state migrant workmen through an intermediary (who has recruited workmen in one state for employment in the establishment situated in another state). The Inter-State migrant workmen, in an establishment to which this Act becomes applicable, are required to be provided certain facilities such as housing, medical aid, traveling expenses from home upto the establishment and back, etc.
- (o) The Building and Other Construction Workers (Regulation of Employment and Conditions of Service) Act 1996 and the Building and Other Construction Workers Welfare Cess Act, 1996 (BOCWW Cess Act): All the establishments who carry on

- any building or other construction work and employ 10 or more workers are covered under these Acts. All such establishments are required to pay cess at the rate not exceeding 2% of the cost of construction as may be notified by the Government. The Employer of the establishment is required to provide safety measures at the building or construction work and other welfare measures, such as Canteens, First – Aid facilities, Ambulance, Housing accommodations for workers near the work place etc. The Employer to whom the Act applies has to obtain a registration certificate from the Registering Officer appointed by the Government.
- (p) Factories Act 1948: the Act lays down the procedure for approval of plans before setting up a factory engaged in manufacturing processes, health and safety provisions, welfare provisions, working hours, annual earned leave and rendering information regarding accidents or dangerous occurrences to designated authorities. It is applicable to premises employing 10 persons or more with aid of power or 20 or more persons without the aid of power.
 - (q) Weekly Holidays Act -1942
 - (r) Bonded Labour System (Abolition) Act, 1976: The Act provides for the abolition of bonded labour system with a view to preventing the economic and physical exploitation of weaker sections of society. Bonded labour covers all forms of forced labour, including that arising out of a loan, debt or advance.
 - (s) Employer’s Liability Act, 1938: This Act protects workmen who bring suits for damages against employers in case of injuries endured in the course of employment. Such injuries could be on account of negligence on the part of the employer or persons employed by them in maintenance of all machinery, equipment etc. in healthy and sound condition.
 - (t) Employees State Insurance Act 1948: The Act provides for certain benefits to insured employees and their families in case of sickness, maternity and disablement arising out of an employment injury. The Act applies to all employees in factories (as defined) or establishments which may be so notified by the appropriate Government. The Act provides for the setting up of an Employees’ State Insurance Fund, which is to be administered by the Employees State Insurance Corporation. Contributions to the Fund are paid by the employer and the employee at rates as prescribed by the Central Government. The Act also provides for benefits to dependents of insured persons in case of death as a result of an employment injury.
 - (u) The Personal Injuries (Compensation Insurance) Act, 1963: This Act provides for the employer’s liability and responsibility to pay compensation to employees where workmen sustain personal injuries in the course of employment.
 - (v) Industrial Employment (Standing Order) Act 1946: It is applicable to all establishments employing 100 or more workmen (employment size reduced by some of the States and Central Government to 50). The Act provides for laying down rules governing the conditions of employment by the Employer on matters

provided in the Act and get the same certified by the designated Authority.

SALIENT FEATURES OF SOME OF THE MAJOR LAWS THAT ARE APPLICABLE FOR PROTECTION OF ENVIRONMENT.

1. The Environment (Protection) Act, 1986 and as amended: This provides for the protection and improvement of environment and for matters connected therewith, and the prevention of hazards to human beings, other living creatures, plants and property. 'Environment' includes water, air and land and the inter-relationship which exists among and between water, air and land, and human beings, other living creatures, plants, micro-organism and property.
2. The Forest Conservation Act, 1980, as amended, and Forest (Conservation) Rules, 1981 as amended: These provides for protection of forests by restricting conversion of forested areas into non- forested areas and prevention of deforestation, and stipulates the procedures for cutting any trees that might be required by the applicable rules. Permissions under the Act also stipulates the norms and compliance requirements of the employer and any contractor on behalf of the employer.
3. State Tree Preservation Acts as may be in force: These provide for protection of trees of important species. Contractors will be required to obtain prior permission for full or partial cutting, uprooting, or pruning of any such trees.
4. The Wildlife (Protection) Act, 1972, and as amended: This provides for protection of wildlife through notifying National Parks and Sanctuaries and buffer areas around these zones; and to protect individuals of nationally important species listed in the Annex of the Act.
5. The Biological Diversity Act, 2002: This provides for conservation of biological diversity, sustainable use of components of biological diversity, and fair and equitable sharing of the benefits arising out of the use of biological resources, knowledge and for matters connected therewith or incidental thereto.
6. The Public Liability Insurance Act, 1991 as amended and The Public Liability Insurance Rules, 1991 as amended: These provide for public liability insurance for the purpose of providing immediate relief to the persons affected by accident occurring while handling hazardous substances and for matters connected herewith or incidental thereto. Hazardous substance means any substance or preparation which is defined as hazardous substance under the Environment (Protection) Act 1986, and exceeding such quantity as may be specified by notification by the Central Government.
7. The Ancient Monuments and Archaeological Sites and Remains Act, 1958 and the Ancient Monuments and Archaeological Sites and Remains (Amendment and Validation) Act, 2010, the Ancient Monuments and Archaeological Sites and Remains Rules, 1959 amended 2011, the National Monuments Authority Rules, 2011 and the similar State Acts: These provide for conservation of cultural and historical remains found in India. Accordingly, area within the radii of 100m and 300m from the "protected property" are designated as "protected area" and "controlled area" respectively. No development activity (including building, mining, excavating, blasting) is permitted in the "protected area" and development activities likely to damage the protected property is not permitted in the "controlled area" without prior

permission of the Archaeological Survey of India (ASI) or the State Departments of Art and Culture or Archaeology as applicable.

8. The Environmental Impact Assessment Notification, 2006 and as amended: This provides for prior environmental clearance for new, modernization and expansion projects listed in Schedule 1 of the Notification. Contractors will be required to ensure that no work starts until applicable clearances under the Notification is not available. Contractors will be responsible for implementation of any environmental management plan stipulated as per the permission under this Notification; and will be required to prepare and submit to the employer and compliance report stipulated in the permission under the Notification.
9. The Water (Prevention and Control of Pollution) Act, 1974 as amended, and the Water (Prevention and Control of Pollution) Rules, 1975 as amended: These provide for the prevention and control of water pollution and the maintaining and restoring of wholesomeness of water. 'Pollution' means such contamination of water or such alteration of the physical, chemical or biological properties of water or such discharge of any sewage or trade effluent or of any other liquid, gaseous or solid substance into water (whether directly or indirectly) as may, or is likely to, create a nuisance or render such water harmful or injurious to public health or safety, or to domestic, commercial, industrial, agricultural or other legitimate uses, or to the life and health of animals or plants or of aquatic organisms. Contractors will need to obtain consent for establishment and consent for operation of any item of work or installation of equipment that generates waste water, and observe the required standards of establishment and operation of these items of work or installations; as well as install and operate all required waste water treatment facilities.
10. The Water (Prevention and Control of Pollution) Cess Act, 1977 and The Water (Prevention and Control of Pollution) Cess Rules, 1978: These provide for the levy and collection of a cess on water consumed by persons carrying on certain industries and by local authorities, with a view to augment the resources of the Central Board and the State Boards for the prevention and control of water pollution under the Water (Prevention and Control of Pollution) Act, 1974.
11. The Air (Prevention and Control of Pollution) Act, 1981 as amended, and the Air (Prevention and Control of Pollution) Rules, 1982: These provides for prevention, control and abatement of air pollution. 'Air Pollution' means the presence in the atmosphere of any 'air pollutant', which means any solid, liquid or gaseous substance (including noise) present in the atmosphere in such concentration as may be or tend to be injurious to human beings or other living creatures or plants or property or environment. Contractors will need to obtain consent for establishment and consent for operation of any item of work or installation of equipment that generates air pollution such as batching plants, hot mix plants, power generators, backup power generation, material handling processes, and observe the required standards of establishment and operation of these items of work or installations.
12. Noise Pollution (Control and Regulation) Rules, 2000, and as amended: This provides for standards for noise for day and night for various land uses and specifies special standards in and around sensitive receptors of noise such as schools and hospitals. Contractors will need to ensure compliance to the applicable standards, and install and operate all required noise control devices as may be required for all plants and work processes.

13. Chemical Accidents (Emergency Planning, Preparedness and Response) Rules, 1996: This provides for Requirement of preparation of on-site and off-site Disaster Management Plans for accident-prone areas.
14. The Explosives Act 1884 and the Explosives Rules, 2008: These provide for safe manufacture, possession, sale, use, transportation and import of explosive materials such as diesel, Oil and lubricants etc.; and also for regulating the use of any explosives used in blasting and/or demolition. All applicable provisions will need compliance by the contractors.
15. The Petroleum Rules, 2002: This provides for safe use and storage of petroleum products, and will need to be complied by the contractors.
16. The Gas Cylinder Rules 2004 and amendments: This provides for regulations related to storage of gas, and possession of gas cylinder more than the exempted quantity. Contractors should comply with all the requirements of this Rule.
17. Manufacture, Storage and Import of Hazardous Chemical Rules of 1989 and as amended: These provide for use and storage of hazardous material such as highly inflammable liquids like HSD/LPG. Contractors will need to ensure compliance to the Rules; and in the event where the storage quantity exceeds the regulated threshold limit, the contractors will be responsible for regular safety audits and other reporting requirements as prescribed in the Rules.
18. Hazardous & Other Wastes (Management and Transboundary Movement) Rules, 2016: These provide for protection of general public from improper handling storage and disposal of hazardous waste. The rules prescribe the management requirement of hazardous wastes from its generation to final disposal. Contractors will need to obtain permission from the State Pollution Control Boards and other designated authorities for storage and handling of any hazardous material; and will to ensure full compliance to these rules and any conditions imposed in the permit.
19. The Bio Medical Waste Management Rules, 2016: This provides for control, storage, transportation and disposal of bio-medical wastes. As and where the contractor has any first aid facility and dispensaries, established in either temporary or permanent manner, compliance to these Rules are mandatory.
20. Construction and Demolition Waste Management Rules, 2016: This provides for management of construction and demolition waste (such as building materials possible to be reused, rubble and debris or the like); and applies to all those waste resulting from construction, re-modelling, repair or demolition of any civil structure. Contractor will need to prepare a waste disposal plan and obtain required approval from local authorities, if waste generation is more than 20 tons in any day or 300 tons in any month during the contract period; and ensure full compliance to these rules and any conditions imposed in the regulatory approval.
21. The E-Waste (Management) Rules, 2016: This provides for management of E-wastes (but not covering lead acid batteries and radio-active wastes) aiming to enable the recovery and/or reuse of useful material from e-waste, thereby reducing the hazardous wastes destined

for disposal and to ensure the environmentally sound management of all types of waste of electrical and electronic equipment. This Rule applies to every manufacturer, producer, consumer, bulk consumer, collection centers, dealers, e-retailer, refurbisher, dismantler and recycler involved in manufacture, sale, transfer, purchase, collection, storage and processing of e-waste or electrical and electronic equipment listed in Schedule I, including their components, consumables, parts and spares which make the product operational.

22. Plastic waste Management Rules, 2016: This provides for control and management of the plastic waste generated from any activity. Contractors will ensure compliance to this Rule.
23. The Batteries (Management and Handling) Rules 2001: This provides for ensuring safe disposal and recycling of discarded lead acid batteries likely to be used in any equipment during construction and operation stage. Rules require proper control and record keeping on the sale or import of lead acid batteries and recollection of the used batteries by registered recyclers to ensure environmentally sound recycling of used batteries. Contractors will ensure compliance to this Rule.
24. The Ozone Depleting Substances (Regulation and Control) Rules, 2000 and as amended: This provides for regulation of production and consumption of ozone depleting substances in the country, and specifically prohibits export to or import from countries not specified in the Rules, and prohibits unless specifically permitted, any use of ozone depleting substance.
25. The Coastal Regulation Zone Notifications, 1991 and as amended: This provides for regulation of development activities within the 500m of high tide line in coastal zone and 100m of stretches of rivers and estuaries influenced by tides. Contractors will be required to ensure that no work starts until applicable clearances under the Notification is not available. Contractors will be responsible for implementation of any plan stipulated as per the permission under this Notification; and will be required to prepare and submit to the employer and compliance report stipulated in the permission under the Notification.
26. The Motor Vehicle Act 1988 as amended (and State Motor Vehicle Acts as may be in force) and the Motor Vehicle Rules, 1989, and as amended (and State Motor Vehicle Rules as may be in force): To minimize the road accidents, penalizing the guilty, provision of compensation to victim and family and check vehicular air and noise pollution. Contractors will be required to ensure full compliance to these rules.
27. Easement Act, 1882: This provides for the rights of landowners on groundwater. Contractors will need to ensure that other landowners' rights under the Act is not affected by any groundwater abstraction by the contractors.
28. State Groundwater Acts and Rules as may be in force and the Guidelines for Groundwater Abstraction for drinking and domestic purposes in Notified Areas and Industry/Infrastructure project proposals in Non-Notified areas, 2012: These provide for regulating extraction of ground water for construction/industrial and drinking and domestic purposes. Contractors will need to obtain permission from Central/State Groundwater Boards prior to groundwater abstraction through digging any bore well or through any other means; and will to ensure full compliance to these rules and any conditions imposed in the permit.

29. The Mines Act, 1952 as amended; the Minor Mineral and concession Rules as amended; and the State Mineral (Rights and Taxation) Acts as may be in force: These provide for for safe and sound mining activity. The contractors will procure aggregates and other building materials from quarries and borrow areas approved under such Acts. In the event the contractors open any new quarry and/or borrow areas, appropriate prior permission from the State Departments of Minerals and Geology will need to be obtained. Contractors will also need to ensure full compliance to these rules and any conditions imposed in the permit.
30. The Insecticides Act, 1968 and Insecticides Rules, 1971 and as amended: These provide for regulates the manufacture, sale, transport, distribution, export, import and use of pesticides to prevent risk to human beings or animals, and for matters connected therewith. No one should import or manufacture; sell, stock or exhibit foe sale; distribute, transport, use: (i) any misbranded insecticides, (ii) any insecticide the sale, distribution or use of which is for the time being prohibited under the Act; and (iii) any insecticide except in accordance with the condition on which it was registered under the Act.
31. National Building Codes of India, 2005 and as amended: This provides guidelines for regulating the building construction activities in India. The code mainly contains administrative regulations, development control rules and general building requirements; stipulations regarding materials, structural design and construction; and building and plumbing services. Contractors will be required to comply with all Bureau of Indian Standards Codes dealing with: (i) use and disposal of asbestos containing materials in construction; (ii) paints containing lead; (iii) permanent and temporary ventilations in workplace; (iv) safety, and hygiene at the workplace; (v) prevention of fire; (vi) prevention of accidents from faulty electrical gadgets, equipment and accessories; and all other such codes incidental to the Contract.

Appendix 2

Tables of Adjustment Data

(not applicable)

(Cl. 49 of GCC)

Table 1: Coefficients governing the adjustment for changes in cost

S. No.	Coefficients Name	Symbol	Schedules (Reference Number)																	
			[Description of each schedule is given below]																	
			S ₁																	
1.	Fixed	a																		
2.	Labour [L]	b																		
3.	Steel [S]	c																		
4.	Cement [C]	d																		
5.	Plant & Equipment spares [E]	e																		
6.	Diesel and Petroleum products [D]	f																		
	Total		100	100	100	100	100	100	100	100	100	100	100	100	100	100	100	100	100	100
			%	%	%	%	%	%	%	%	%	%	%	%	%	%	%	%	%	%

Note: (a) Fixed element is normally 15%; (b) Employer to fill-up above Table.

BOQ SCHEDULES

Schedule is enclosed vide Annexure I.

Table 2: Cost Indices and Reference Prices (applicable for specific items) for adjustment in contract prices [as per GCC 49].

WPI with base 2004-2005 = 100 on the Base Date

Base Date = Deadline for submission of bids

S. No.	Cost Element	Symbol	Indices or Cost on the Base Date	Index for adjustment	Sources of Index
[1]	[2]	[3]	[4]	[5]	[6]
1.	Fixed	a			
2.	Labour	b	L ₀ - all India average Consumer Price Index(CPI) Number for	L _n -CPI for the month for which the IPC is related	Labour Bureau, Ministry of Labour and Employment, Government of India.

			Industrial Workers for centre ¹⁵ (Base 2001 = 100) on the base date.		
3.	Steel	c	S _o – Whole-sale Price Index (WPI) for Steel [<i>Steel Long</i>]	S _n -WPI for the month which is two months prior to the month to which IPC is related	Economic Advisor, Ministry of Commerce and Industry, Government of India.
4.	Cement	d	C _o -WPI for Grey Cement	C _n -WPI for the month which the cement is brought to site or one month prior to the month to which IPC is related, whichever is less	Economic Advisor, Ministry of Commerce and Industry, Government of India
5.	Plant & Equipment spares	e	E _o -WPI for “Construction machinery ”	E _n – WPI for the month to which IPC is related	Economic Advisor, Ministry of Commerce and Industry, Government of India
6.	Diesel ¹⁶	f	Do-Unit Cost from the identified depot on the base date	D _n -Unit Cost for on the first day of the month to which the IPC relates	From the Depot
7.	Bitumen ¹⁷	g	Bo-Unit Cost from the identified refinery on the base date	B _n - Cost per unit quantity on the first day of the month in which the material is brought to site or two months prior to the date to which IPC is related	From Refinery
8.	Others	h	O _o - All India Wholesale Price Index(WPI) for all commodities	O _n - All India WPI for all commodities for the month to which IPC is related	Economic Advisor, Ministry of Commerce and Industry, Government of India

IPC – Interim Payment Certificate

¹⁵ The Centre to be specified should be the relevant one for which CPI is published by the Labour Bureau.

¹⁶ The PCC specifies the identified depot for the rate of diesel for the base date and the applicable date for price adjustment.

¹⁷ The PCC specifies the identified refinery for the rate of Bitumen for the base date and the applicable date price adjustment.

Appendix -3¹⁸
Appointment of Adjudicator

Suggested Draft of **Letter of Appointment of Adjudicators** in civil works contracts

Sub: _____ (Name of the Contract)

To

Name and address of the Adjudicator

We hereby confirm your appointment as Adjudicator for the above contract to carry out the assignment specified in this Letter of Appointment.

For administrative purpose _____ (*name of the officer representing the Employer*) has been assigned to administer the assignment and to provide the Adjudicator with all relevant information needed to carry out the assignment on behalf of both the employer and the contractor. The services will be required during the period of contract for the work of (Name of the Contract) _____.

The Adjudicator shall visit the worksite once in 3 (three) months till the completion of the work indicated above or as specifically requested by Employer/ Contractor for the period upto the end of defects liability period with prior intimation to the Employer and the contractor. The duration of each visit shall ordinarily be for one day only. These durations are approximate and (*Name of the employer and Name of the Contractor*) may find it necessary to postpone or cancel the assignment and/or shorten or extend the duration.

The appointment will become effective upon confirmation of letter by you. The appointment of Adjudicator shall be liable for termination under a 30 (thirty) days written notice from the date of issue of the notice, if both Employer and the Contractor so desire. Also the appointment shall automatically stand terminated 14 days after the defect notice / correction period as stated in Clauses 23 and 24 of the Conditions of Contract is over.

The Adjudicator will be paid a fee of Rs. _____ (Rupees _____ only) per each day of visit at the worksite. The actual expenses for boarding and traveling in connection with the assignment will be reimbursed to the Adjudicator. The Adjudicator will submit a pre-receipted bill in triplicate to the employer indicating the date of the visit, fees for the visit and a proof in support of the actual expenditure [only for items valued above Rs. 500 each] incurred by him against boarding, lodging and traveling expenses after performing the visit on each occasion. The Employer will make the admissible payment (both the Employer's and the Contractor's share) to the Adjudicator within 30 days of the receipt of the bill. The Contractor's share on this account (half the paid amount) will be recovered by the Employer from the Contractor's bills against the work.

¹⁸ If ITB 51 makes provision of an Adjudicator from list provided by an institution, kindly modify Appendix 3 to state that the fee and reimbursable payable to the adjudicator shall be as per the rules of the Institution.

In accepting this assignment, the Adjudicator should understand and agree that he is responsible for any liabilities and costs arising out of risks associated with travel to and from the place of emergency repatriation, loss or damage to personal/professional effects and property. The Adjudicator is advised to effect personal insurance cover in respect of such risks if he does not already have such cover in place. In this regard, the Adjudicator shall maintain appropriate medical, travel, accident and third-party liability insurance. The obligation under this paragraph will survive till termination of this appointment.

Procedures for resolution of disputes by the Adjudicator is described in the contract of _____(name of the contract) between the employer and the contractor vide Clause No.24 of the General Conditions of Contract. Your recommendation should be given in the format attached, within 28 days of receipt of a notification of dispute.

The Adjudicator will carry out the assignment in accordance with the highest standard of professional and ethical competence and integrity, having due regard to the nature and purpose of the assignment, and will conduct himself in a manner consistent herewith. After visiting the worksite, the Adjudicator will discuss the matter with the Employer and if necessary with the Contractor before arriving at any decision.

The Adjudicator will agree that all knowledge and information not within the public domain, which may be acquired while carrying out this service shall be all time and for all purpose, regarded as strictly confidential and held in confidence, and shall not be directly or indirectly disclosed to any party whatsoever, except with the permission of the employer and the contractor. The Adjudicator's decision should be communicated in the form of a speaking order specifying the reasons.

The Adjudicator will agree that any manufacturing or construction firm with which he might be associated with, will not be eligible to participate in bidding for any goods or works resulting from or associated with the project of which this consulting assignment forms a part

Read and Agreed

Name of Adjudicator

Signature

Place:

Date:

Name of Employer

Signature of authorized representative of Employer

Name of the Contractor

Signature of authorized representative of Contractor

Attachment: Copy of contract document between the employer and contractor and format for recommendation.

SUMMARY OF ADJUDICATOR'S RESPONSIBILITIES

The Adjudicator has the following principal responsibilities:

1. Visit the site periodically.
2. Keep abreast of job activities and developments.
3. Encourage the resolution of disputes by the parties.
4. When a dispute is referred to it, conduct a hearing (no legal presentation), complete its deliberations, and prepare a recommendations in a professional and timely manner (as per sample format)

Sample Format of Adjudicator's Recommendation

[Project Name] Recommendation of Adjudicator

Dispute No. XX [NAME OF DISPUTE]

Hearing Date: _____

Dispute

Description of dispute. A one or two sentence summation of the dispute.

Contractor's Position

A short summation of the contractor's position as understood by the Adjudicator.

Employer's Position

A short summation of the Employer's position as understood by the Adjudicator.

Recommendation

The Adjudicator's specific recommendation for settlement of the dispute. (*The recommended course is consistent with the explanation*).

Explanation

(*This section could also be called Considerations, Rationale, Findings, Discussion, and so on.*)

The Adjudicator's description of how each recommendation was reached.

Respectfully submitted,

Date : _____

Date : _____

Date : _____

Section X - Contract Forms

This Section contains forms which, once completed, will form part of the Contract. The forms for Performance Security, ES performance security if applicable, and Advance Payment Security, when required, shall only be completed by the successful Bidder after contract award.

NOTIFICATION OF AWARD

Letter of Acceptance

[on letterhead paper of the Employer]

[The Letter of Acceptance shall be the basis for formation of the Contract as described in ITB Clause 47. This Standard Form of Letter of Acceptance shall be filled in and sent to the successful Bidder only after evaluation of bids has been completed, subject to any review by the World Bank required under the Loan Agreement.]

..... *[date]*

To: *[name and address of the Contractor]*

Subject: *[Notification of Award Contract No]*

This is to notify you that your Bid dated *[insert date]* for execution of the
 *[insert name of the contract and identification number, as given in the PCC]* . .
 for the Accepted Contract Amount of *[insert amount in numbers and words]*, as corrected and modified¹⁹ in accordance with the Instructions to Bidders is hereby accepted by our Agency.

You are requested to furnish the Performance Security, plus additional security for unbalanced bids in terms of ITB Clause 41, and ES Performance Security *[Delete ES Performance Security if it is not required under the contract]* in the form detailed in ITB Clause 50 for amounts²⁰ of Rs., and Rs. specified therein, within 21 days of the receipt of this letter of acceptance, and visit this office to sign the contract, failing which action as stated in ITB Clause 50.2 will be taken in accordance with the Conditions of Contract. The securities shall be valid upto 28 days from the date of completion i.e. upto and shall be as per the Performance Security Form and the ES Performance Security Form *[Delete reference to the ES Performance Security Form if it is not required under the contract]*, included in Section X -Contract Forms, of the bidding document.

[Choose one of the following statements:]

We accept that _____ *[insert the name of Adjudicator proposed by the Bidder]* be appointed as the Adjudicator²¹.

[or]

¹⁹Delete "corrected and" or "and modified" if not applicable. See Notes on Standard Form of Agreement, next page.

²⁰Insert amounts for (i) Performance Security, plus additional security for unbalanced bids in terms of ITB Clause 41; and (ii) ES Performance Security respectively.

²¹To be used only if the Contractor disagrees in the Bid with the Adjudicator proposed by the Employer in the Instructions to Bidders, and has accordingly offered another candidate.

We do not accept that _____ *[insert the name of the Adjudicator proposed by the Bidder]* be appointed as the Adjudicator, and by sending a copy of this Letter of Acceptance to _____ *[insert name of the Appointing Authority]*, the Appointing Authority, we are hereby requesting such Authority to appoint the Adjudicator in accordance with ITB 51.1 and GCC 23.1²².

We note that as per your bid, you do not intend to subcontract any component of work.

[OR]

We note that as per your bid, you propose to employ M/s. as sub-contractor for executing

We have reviewed the construction methodology submitted by you alongwith the bid in response to ITB Clause 16 and our comments are given in the attachment. You are requested to submit a revised Program including ES requirements as per Clause 30 of General Conditions of Contract within 14 days of receipt of this letter of acceptance.

Authorized Signature:

Name and Title of Signatory:

Name of Agency:

²²To be used only if the Contractor disagrees in the Bid with the Adjudicator proposed by the Employer in the ITB, has accordingly offered another candidate, and the Employer does not accept the counterproposal.

Issue of Notice to proceed with the work

(letterhead of the Employer)

_____ (date)

To

_____ (name and address of the Contractor)

Dear Sirs:

Pursuant to your furnishing the requisite securities as stipulated in ITB clause 50.1, insurance policy as per GCC 13, construction methodology as stated in letter of acceptance and signing of the contract agreement for the construction of _____ @ a Bid Price of Rs. _____, you are hereby instructed to proceed with the execution of the said works in accordance with the contract documents.

Yours faithfully,

(Signature, name and title of
signatory authorized to sign on
behalf of Employer)

Attachment: Contract Agreement

Contract Agreement

THIS AGREEMENT made theday of,, between
 . *[name of the Employer]*. (hereinafter “the Employer”), of the one part, and
 . . *[name of the Contractor]*.(hereinafter “the Contractor”), of the other part:

WHEREAS the Employer desires that the Works known as *[name of the Contract]*.
should be executed by the Contractor, and has accepted a Bid by the Contractor for
 the execution and completion of these Works and the remedying of any defects therein,

The Employer and the Contractor agree as follows:

1. In this Agreement words and expressions shall have the same meanings as are respectively assigned to them in the Contract documents referred to.
2. The following documents shall be deemed to form and be read and construed as part of this Agreement. This Agreement shall prevail over all other Contract documents.
 - (i) This Agreement
 - (ii) the Letter of Acceptance
 - (iii) the Contractor’s Bid including completed schedules and priced bill of quantities,
 - (iv) the addenda Nos _____(if any)
 - (v) the Particular Conditions
 - (vi) the General Conditions of Contract, including appendix;
 - (vii) the Specification
 - (viii) the Drawings
 - (ix) Construction Program, Methodology, Quality Assurance Program, the ES Management Strategies and Implementation Plans, and Code of Conduct for Contractor’s Personnel (ES)
 - (x) Joint Venture Agreement [for JVs only];and
 - (xi) any other document **listed in the PCC** as forming part of the Contract.
3. In consideration of the payments to be made by the Employer to the Contractor as specified in this Agreement, the Contractor hereby covenants with the Employer to execute the Works and to remedy defects therein in conformity in all respects with the provisions of the Contract.
4. The Employer hereby covenants to pay the Contractor in consideration of the execution and completion of the Works and the remedying of defects therein, the Contract

Price or such other sum as may become payable under the provisions of the Contract at the times and in the manner prescribed by the Contract.

IN WITNESS whereof the parties hereto have caused this Agreement to be executed in accordance with the laws of India on the day, month and year specified above.

Signed by: _____
for and on behalf of the Employer

Signed by: _____
for and on behalf the Contractor

in the
presence of: _____
Witness, Name, Signature, Address,
Date

in the
presence of: _____
Witness, Name, Signature, Address, Date

Performance Security- Bank Guarantee
[including Additional Performance Security for unbalanced bids]
[Guarantor letterhead or SWIFT identifier code]

Performance Guarantee No..... *[insert guarantee reference number]*

Date..... *[insert date of issue of the guarantee]*

To: _____ *[name of Employer]*

_____ *[address of Employer]*

WHEREAS _____ *[name and address of Contractor²³]* (hereinafter called "the Applicant") has undertaken, in pursuance of Contract No. _____ dated _____ to execute _____ *[name of Contract and brief description of Works]* (hereinafter called "the Contract");

AND WHEREAS it has been stipulated by you in the said Contract that the Applicant shall furnish you with a Bank Guarantee by a recognized bank for the sum specified therein as security for compliance with his obligations in accordance with the Contract;

AND WHEREAS we have agreed to give the Applicant such a Bank Guarantee;

NOW THEREFORE we hereby affirm that we are the Guarantor and responsible to you, on behalf of the Applicant, up to a total of _____ *[amount of guarantee²⁴]* _____ *[in words]*, such sum being payable in the types and proportions of currencies in which the Contract Price is payable, and we undertake to pay you, upon your first written demand and without cavil or argument, any sum or sums within the limits of _____ *[amount of guarantee]* as aforesaid without your needing to prove or to show grounds or reasons for your demand for the sum specified therein.

We hereby waive the necessity of your demanding the said debt from the Applicant before presenting us with the demand.

We further agree that no change or addition to or other modification of the terms of the Contract or of the Works to be performed thereunder or of any of the Contract documents which may

²³*In the case of a JV, insert the name of the Joint Venture*

²⁴*An amount shall be inserted by the Guarantor, representing the percentage of the Contract Price specified in the Contract less provisional sums, if any, plus additional performance security for unbalanced bids if any, and denominated in Indian Rupees.*

be made between you and the Applicant shall in any way release us from any liability under this guarantee, and we hereby waive notice of any such change, addition or modification.

This guarantee shall be valid until²⁵, and any demand for payment under it must be received by us at this office on or before that date.

Signature and seal of the guarantor _____

Name of Bank _____

Address _____

Date _____

Note: All italicized text (including footnotes) is for use in preparing this form and shall be deleted from the final product.

²⁵*Insert the date twenty-eight days after the expected completion date as described in GC Clause 53.1. The Employer should note that in the event of an extension of this date for completion of the Contract, the Employer would need to request an extension of this guarantee from the Guarantor. Such request must be in writing and must be made prior to the expiration date established in the guarantee. In preparing this guarantee, the Employer might consider adding the following text to the form, at the end of the penultimate paragraph: "The Guarantor agrees to a one-time extension of this guarantee for a period not to exceed [six months][one year], in response to the Employer's written request for such extension, such request to be presented to the Guarantor before the expiry of the guarantee"*

Environmental and Social (ES) Performance Security ES – Bank Guarantee

[Guarantor letterhead or SWIFT identifier code]

ES Performance Guarantee No.: *[Insert guarantee reference number]*

Date..... *[insert date of issue of the guarantee]*

To: _____ *[name of Employer]*

_____ *[address of Employer]*

WHEREAS _____ *[name and address of Contractor²⁶]* (hereinafter called "the Applicant") has undertaken, in pursuance of Contract No. _____ dated _____ to execute _____ *[name of Contract and brief description of Works]* (hereinafter called "the Contract");

AND WHEREAS it has been stipulated by you in the said Contract that the Applicant shall furnish you with a Bank Guarantee by a recognized bank for the sum specified therein as security for compliance with his Environmental and/or Social (ES) obligations in accordance with the Contract;

AND WHEREAS we have agreed to give the Applicant such a Bank Guarantee;

NOW THEREFORE we hereby affirm that we are the Guarantor and responsible to you, on behalf of the Applicant, up to a total of _____ *[amount of guarantee²⁷]* _____ *[in words]*, such sum being payable in the types and proportions of currencies in which the Contract Price is payable, and we undertake to pay you, upon your first written demand and without cavil or argument, any sum or sums within the limits of _____ *[amount of guarantee]* as aforesaid without your needing to prove or to show grounds or reasons for your demand for the sum specified therein.

We hereby waive the necessity of your demanding the said debt from the Applicant before presenting us with the demand.

We further agree that no change or addition to or other modification of the terms of the Contract or of the Works to be performed thereunder or of any of the Contract documents which may

²⁶*In the case of a JV, insert the name of the Joint Venture*

²⁷*An amount shall be inserted by the Guarantor, representing the percentage of the Contract Price specified in the Contract less provisional sums, if any, and denominated in Indian Rupees.*

be made between you and the Applicant shall in any way release us from any liability under this guarantee, and we hereby waive notice of any such change, addition or modification.

This guarantee shall be valid until²⁸, and any demand for payment under it must be received by us at this office on or before that date.

Signature and seal of the guarantor _____

Name of Bank _____

Address _____

Date _____

Note: All italicized text (including footnotes) is for use in preparing this form and shall be deleted from the final product.

²⁸*Insert the date twenty-eight days after the expected completion date as described in GC Clause 53.1. The Employer should note that in the event of an extension of this date for completion of the Contract, the Employer would need to request an extension of this guarantee from the Guarantor. Such request must be in writing and must be made prior to the expiration date established in the guarantee. In preparing this guarantee, the Employer might consider adding the following text to the form, at the end of the penultimate paragraph: "The Guarantor agrees to a one-time extension of this guarantee for a period not to exceed [six months][one year], in response to the Employer's written request for such extension, such request to be presented to the Guarantor before the expiry of the guarantee"*

Advance Payment Security
Demand Guarantee
[Guarantor letterhead or SWIFT identifier code]

Advance Payment Guarantee No..... *[insert guarantee reference number]*

Date..... *[insert date of issue of the guarantee]*

To: _____ *[name of Employer]*
 _____ *[address of Employer]*
 _____ *[name of Contract]*

Gentlemen:

In accordance with the provisions of the Conditions of Contract, Subclause 53.1 ("Advance Payment") of the above-mentioned Contract, _____ *[name and address of Contractor²⁹]* (hereinafter called "the Applicant") shall deposit with _____ *[name of Employer]* a bank guarantee to guarantee his proper and faithful performance under the said Clause of the Contract in an amount of _____ *[amount of guarantee³⁰]* _____ *[in words]*.

We, the _____ *[bank or financial institution]*, as instructed by the Applicant, agree unconditionally and irrevocably to guarantee as primary obligator and not as Surety merely, the payment to _____ *[name of Employer]* on his first demand without whatsoever right of objection on our part and without his first claim to the Applicant, in the amount not exceeding _____ *[amount of guarantee]* _____ *[in words]*.

We further agree that no change or addition to or other modification of the terms of the Contract or of Works to be performed thereunder or of any of the Contract documents which may be made between _____ *[name of Employer]* and the Applicant, shall in any way release us from any liability under this guarantee, and we hereby waive notice of any such change, addition or modification.

²⁹In the case of a JV, insert the name of the Joint Venture

³⁰An amount shall be inserted by the bank representing the amount of the Advance Payment, and denominated in Indian Rupees.

This guarantee shall remain valid and in full effect from the date of the advance payment under the Contract until _____ [*name of Employer*] receives full repayment of the same amount from the Applicant. Consequently any demand for payment under this guarantee must be received by us at this office on or before that date.

Yours truly,

Signature and seal: _____

Name of Bank: _____

Address: _____

Date: _____

Note: All italicized text (including footnotes) is for use in preparing this form and shall be deleted from the final product.

Retention Money Security
Demand Guarantee
[Guarantor letterhead or SWIFT identifier code]

_____ *[Bank's name and address of issuing branch or office]*

Beneficiary: _____ *[Name and Address of Employer]*

Date: _____

RETENTION MONEY GUARANTEE NO.: _____

We have been informed that _____ *[name of contractor³¹]* (hereinafter called "the Applicant") has entered into Contract No. _____ *[reference number of the contract]* dated _____ with you, for the execution of _____ *[name of contract and brief description of Works]* (hereinafter called "the Contract").

Furthermore, we understand that, according to the conditions of the Contract, when the Taking-Over Certificate has been issued for the Works and the first half of the Retention Money has been certified for payment, payment of _____ *[insert the second half of the Retention Money]* is to be made against a Retention Money guarantee.

At the request of the Applicant, we _____ *[name of Bank]* hereby irrevocably undertake to pay you the sum or sums not exceeding in total an amount of _____ *[amount in Rupees]* (_____) *[amount in words³²]* upon receipt by us of your first demand in writing accompanied by a written statement stating that the Applicant is in breach of its obligation under the Contract without cavil or argument.

It is a condition for any claim and payment under this guarantee to be made that the payment of the second half of the Retention Money referred to above must have been received by the Applicant on its account number _____ at _____ *[name and address of Bank]*.

³¹*In the case of a JV, insert the name of the Joint Venture*

³²*The Guarantor shall insert an amount representing the amount of the second half of the Retention Money or if the amount guaranteed under the Performance Guarantee when the Taking-Over Certificate is issued is less than half of the Retention Money, the difference between half of the Retention Money and the amount guaranteed under the Performance Security.*

This guarantee shall expire, at the latest, 21 days after the date when the Employer has received a copy of the Defects Liability Certificate issued by the Project Manager. Consequently, any demand for payment under this guarantee must be received by us at this office on or before that date.

[Signature(s) and seal of the guarantor]

Note: All italicized text (including footnotes) is for use in preparing this form and shall be deleted from the final product.

Attachment 1**Amendments for Permitting Standstill Period³³
(Refer ITB Clause 44)**

In works contracts where it is proposed to permit Standstill Period [*in the case of high risk or specialized/complex works only*], the following corrections shall be incorporated in this document

1. Instructions to Bidders & Bid Data Sheet**1.1 Insert ITB 44.1 as under:**

44.1 The Contract shall be awarded not earlier than the expiry of the Standstill Period. The duration of the Standstill Period is **specified in the BDS**. Where only one Bid is submitted, the Standstill Period shall not apply.

1.2 Insert ITB 45.1 as under:

45.1 When a Standstill Period applies, it shall commence when the Employer has transmitted to each Bidder (that has not already been notified that it has been unsuccessful) the Notification of Intention to Award the Contract to the successful Bidder. The Notification of Intention to Award shall contain, at a minimum, the following information:

- (a) the name and address of the Bidder submitting the successful Bid;
- (b) the Contract price of the successful Bid;
- (c) the names of all Bidders who submitted Bids, and their Bid prices as readout, and as evaluated;
- (d) a statement of the reason(s) the Bid (of the unsuccessful Bidder to whom the letter is addressed) was unsuccessful, unless the price information in (c) above already reveals the reason;
- (e) the expiry date of the Standstill Period;
- (f) instructions on how to request a debriefing and/or submit a complaint during the standstill period.

1.3 Substitute ITB 47.1 as under:

47.1 Prior to the expiration of the Bid Validity Period and upon expiry of the Standstill Period, specified in BDS ITB 44.1 or any extension thereof, or upon satisfactorily addressing a complaint that has been filed within the Standstill Period, the Employer shall transmit the Letter of Acceptance to the successful Bidder. The Letter of Acceptance shall specify the sum that the Employer will pay the Contractor

³³These are instructions for the Borrower and should be removed from final bid document.

in consideration of the execution of the contract (hereinafter and in the Conditions of Contract and Contract Forms called “the Contract Price”).

1.4 Insert ITB 48 as under:

48. Debriefing by the Employer

48.1 On receipt of the Employer’s Notification of Intention to Award referred to in ITB 45.1, an unsuccessful Bidder has three (3) Business Days to make a written request to the Employer for a debriefing. The Employer shall provide a debriefing to all unsuccessful Bidders whose request is received within this deadline.

48.2 Where a request for debriefing is received within the deadline, the Employer shall provide a debriefing within five (5) Business Days, unless the Employer decides, for justifiable reasons, to provide the debriefing outside this timeframe. In that case, the standstill period shall automatically be extended until five (5) Business Days after such debriefing is provided. If more than one debriefing is so delayed, the standstill period shall not end earlier than five (5) Business Days after the last debriefing takes place. In any case, irrespective of the circumstances, all debriefings shall be completed within 10 business days. The Employer shall promptly inform, by the quickest means available, all Bidders of the extended standstill period.

48.3 Where a request for debriefing is received by the Employer later than the three (3)-Business Day deadline, the Employer should provide the debriefing as soon as practicable, and normally no later than fifteen (15) Business Days from the date of publication of Public Notice of Award of contract. Requests for debriefing received outside the three (3)-day deadline shall not lead to extension of the standstill period.

48.4 Debriefings of unsuccessful Bidders may be done in writing or verbally. The debriefing will cover only the bid of particular bidder requesting the debriefing, and not the bids of the competitors. The Bidder shall bear its own costs of attending such a debriefing meeting.

1.5 Insert ITB 52 as under:

52. Procurement Related Complaint

52.1 The procedures for making a Procurement-related Complaint are as specified in the BDS.

1.6 Insert BDS ITB 44 as under:

ITB 44 Standstill Period

The Standstill Period is 10 Business Days [*note: the minimum number of Business Days is ten (10)*] after the date the Employer has transmitted to all Bidders that submitted a Bid, the Notification of its Intention to Award the Contract to the successful Bidder.

Note: Where a Bidder has previously received notification, in accordance with ITB 34.1, that its Technical Part of Bid failed to meet the requirements of the bidding document, the Bidder will not receive a Notification of Intention to Award the Contract.

[If this Bidding process is in response to an emergency situation recognized by the Bank state: “No Standstill Period applies to this Bidding process.”]

1.7 Insert BDS ITB 52.1 as under:

.....

ITB 52.1

The procedures for making a Procurement-related Complaint are detailed in the “Procurement Regulations for IPF Borrowers (Annex III).” If a Bidder wishes to make a Procurement-related Complaint, the Bidder should submit its complaint following these procedures, in writing (by the quickest means available, that is either by email or fax), to:

For the attention: *[insert full name of person receiving complaints]*

Title/position: *[insert title/position]*

Employer: *[insert name of Employer]*

Email address: *[insert email address]*

Fax number: *[insert fax number] delete if not used*

In summary, a Procurement-related Complaint may challenge any of the following:

1. the terms of the Bidding Document;
 2. the Employer’s decision to exclude a Bidder from the procurement process prior to the award of contract; and
 3. the Employer’s decision to award the contract.
-

2. Contract Forms

2.1 Insert the Form ‘Notification of Intention to Award’ as under:

.....

Notification of Intention to Award

[This Notification of Intention to Award shall be sent to each Bidder that submitted a Bid, unless the Bidder has previously received notice of exclusion from the process at an interim stage of the procurement process]

[Send this Notification to the Bidder’s Authorized Representative named in the Bidder Information Form]

For the attention of Bidder’s Authorized Representative

Name: *[insert Authorized Representative’s name]*

Address: *[insert Authorized Representative’s Address]*

Telephone/Fax numbers: *[insert Authorized Representative’s telephone/fax numbers]*

Email Address: *[insert Authorized Representative’s email address]*

[IMPORTANT: insert the date that this Notification is transmitted to Bidders. The Notification must be sent to all Bidders simultaneously. This means on the same date and as close to the same time as possible.]

DATE OF TRANSMISSION: This Notification is sent by: *[email/fax]* on *[date]* (local time)

Notification of Intention to Award

Employer: *[insert the name of the Employer]*

Project: *[insert name of project]*

Contract title: *[insert the name of the contract]*
Country: *[insert country where RFB is issued]*
Loan No. /Credit No. / Grant No.: *[insert reference number for loan/credit/grant]*
RFB No: *[insert RFB reference number from Procurement Plan]*

This Notification of Intention to Award (Notification) notifies you of our decision to award the above contract. The transmission of this Notification begins the Standstill Period. During the Standstill Period, you may:

- a) request a debriefing in relation to the evaluation of your Bid, and/or
- b) submit a Procurement-related Complaint in relation to the decision to award the contract.

1. The successful Bidder

Name:	<i>[insert name of successful Bidder]</i>
Address:	<i>[insert address of the successful Bidder]</i>
Contract price:	<i>[insert contract price of the successful Bid]</i>

2. Other Bidders *[INSTRUCTIONS: insert names of all Bidders that submitted a Bid. If the Bid's price was evaluated include the evaluated price as well as the Bid price as read out.]*

Name of Bidder	Bid price	Evaluated Bid price (if applicable)
<i>[insert name]</i>	<i>[insert Bid price]</i>	<i>[insert evaluated price]</i>
<i>[insert name]</i>	<i>[insert Bid price]</i>	<i>[insert evaluated price]</i>
<i>[insert name]</i>	<i>[insert Bid price]</i>	<i>[insert evaluated price]</i>
<i>[insert name]</i>	<i>[insert Bid price]</i>	<i>[insert evaluated price]</i>
<i>[insert name]</i>	<i>[insert Bid price]</i>	<i>[insert evaluated price]</i>

3. Reason/s why your Bid was unsuccessful

[INSTRUCTIONS: State the reason/s why this Bidder's Bid was unsuccessful. Do NOT include: (a) a point by point comparison with another Bidder's Bid or (b) information that is marked confidential by the Bidder in its Bid.]

4. How to request a debriefing

DEADLINE: The deadline to request a debriefing expires at midnight on *[insert date]* (local time).

You may request a debriefing in relation to the results of the evaluation of your Bid. If you decide to request a debriefing your written request must be made within three (3) Business Days of receipt of this Notification of Intention to Award.

Provide the contract name, reference number, name of the Bidder, contact details; and address the request for debriefing as follows:

Attention: *[insert full name of person, if applicable]*

Title/position: *[insert title/position]*

Agency: *[insert name of Employer]*

Email address: *[insert email address]*

Fax number: *[insert fax number] delete if not used*

If your request for a debriefing is received within the 3 Business Days deadline, we will provide the debriefing within five (5) Business Days of receipt of your request. If we are unable to provide the debriefing within this period, the Standstill Period shall be extended by five (5) Business Days after the date that the debriefing is provided. If this happens, we will notify you and confirm the date that the extended Standstill Period will end.

The debriefing may be in writing, by phone, video conference call or in person. We shall promptly advise you in writing how the debriefing will take place and confirm the date and time.

If the deadline to request a debriefing has expired, you may still request a debriefing. In this case, we will provide the debriefing as soon as practicable, and normally no later than fifteen (15) Business Days from the date of publication of the Contract Award Notice.

5. How to make a complaint

Period: Procurement-related Complaint challenging the decision to award shall be submitted by midnight, *[insert date]* (local time).

Provide the contract name, reference number, name of the Bidder, contact details; and address the Procurement-related Complaint as follows:

Attention: *[insert full name of person, if applicable]*

Title/position: *[insert title/position]*

Agency: *[insert name of Employer]*

Email address: *[insert email address]*

Fax number: *[insert fax number] delete if not used*

At this point in the procurement process, you may submit a Procurement-related Complaint challenging the decision to award the contract. You do not need to have requested, or received, a debriefing before making this complaint. Your complaint must be submitted within the Standstill Period and received by us before the Standstill Period ends.

Further information:

For more information see the [Procurement Regulations for IPF Borrowers \(Procurement Regulations\)](https://policies.worldbank.org/sites/ppf3/PPFDocuments/Forms/DispPage.aspx?docid=4005) [https://policies.worldbank.org/sites/ppf3/PPFDocuments/Forms/DispPage.aspx?docid=4005] (Annex III). You should read these provisions before preparing and submitting your complaint. In addition, the World Bank's Guidance "[How to make a Procurement-related Complaint](http://www.worldbank.org/en/projects-operations/products-and-services/brief/procurement-new-framework#framework)" [http://www.worldbank.org/en/projects-operations/products-and-services/brief/procurement-new-framework#framework] provides a useful explanation of the process, as well as a sample letter of complaint.

In summary, there are four essential requirements:

1. You must be an 'interested party'. In this case, that means a Bidder who submitted a Bid in this bidding process, and is the recipient of a Notification of Intention to Award.
2. The complaint can only challenge the decision to award the contract.
3. You must submit the complaint within the period stated above.
4. You must include, in your complaint, all of the information required by the Procurement Regulations (as described in Annex III).

6. Standstill Period

DEADLINE: The Standstill Period is due to end at midnight on [insert date] (local time).

The Standstill Period lasts ten (10) Business Days after the date of transmission of this Notification of Intention to Award.

The Standstill Period may be extended as stated in Section 4 above.

If you have any questions regarding this Notification, please do not hesitate to contact us.

On behalf of the Employer:

Signature: _____

Name: _____

Title/position: _____

Telephone: _____

Email: _____

.....

2.2 Substitute the first note in Italics in the Form ‘Notification of Award’ as under:

[The Letter of Acceptance shall be the basis for formation of the Contract as described in ITB Clause 47. This Standard Form of Letter of Acceptance shall be filled in and sent to the successful Bidder only upon expiry of the Standstill Period, specified in BDS ITB 44.1 or any extension thereof, or upon satisfactorily addressing a complaint that has been filed within the Standstill Period, subject to any review by the World Bank required under the Loan Agreement.]

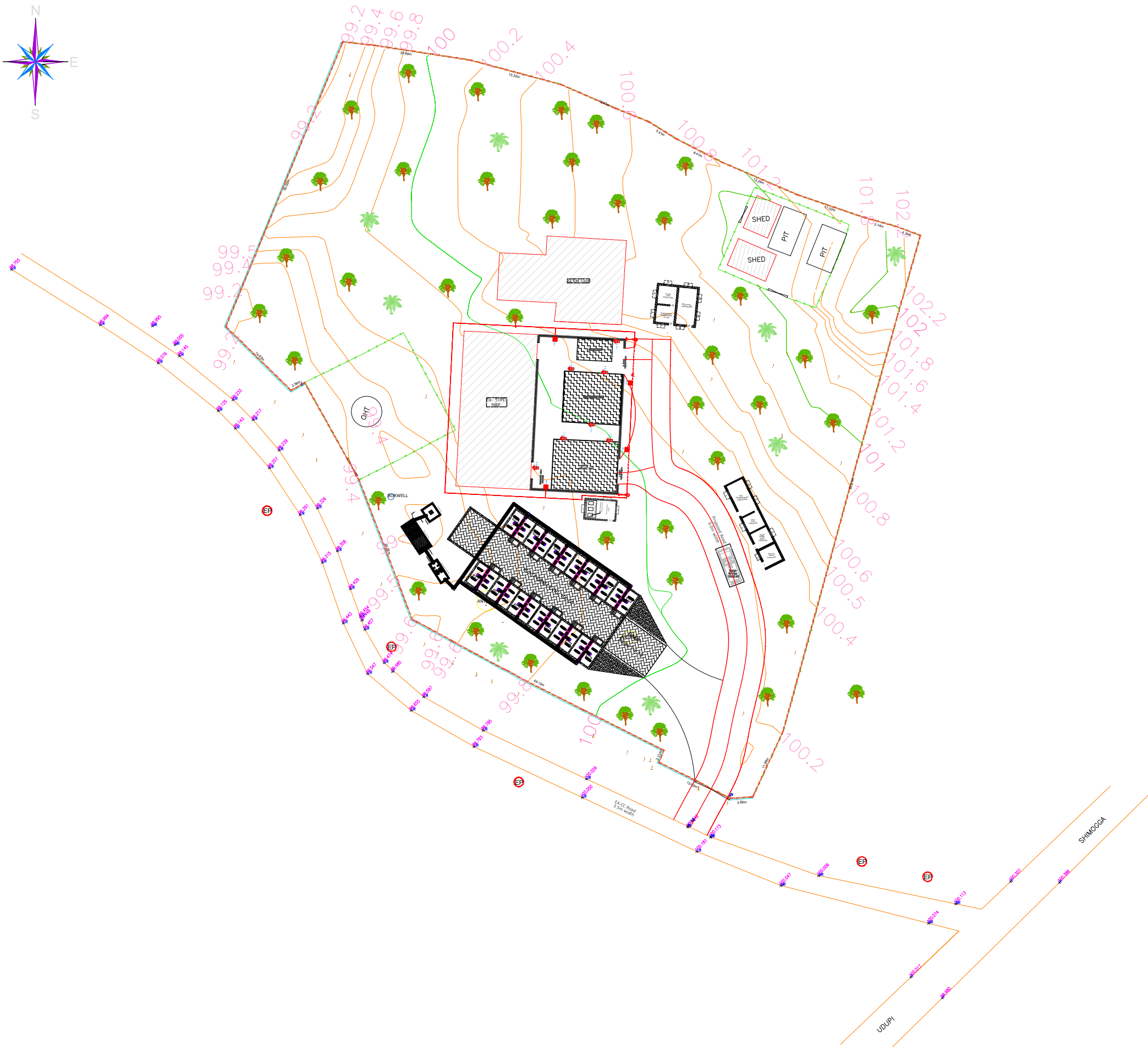
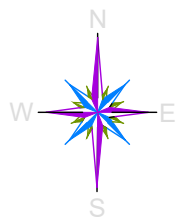

- NOTE:
1. All dimensions are in 'm' unless mentioned otherwise.
 2. All dimensions are checked and co-related with the architectural drawings and any discrepancy or omission shall be brought to the notice.
 3. This is the property of 'SV Associates' & is not to be copied or produced anywhere without their permission.
 4. The structural component and BOQ prepared considering road level at (+100.00)
 5. All Plastering must be Mixed with water proofing agent.
 6. All water treatment structure to be checked for water leakages.
 7. All reinforcement shall be terminated inside the structure and shall not be protruding outside.
 8. Structure drawing shall supersede design drawing for any mismatch.
 9. All foundation and structure to be erected on well compacted earth with proctor density of 95%.

RO	FOR SUBMISSION	24.09.2024	VS	JV	PS	CHN
Rev.	Description.	Date	Drw.	Dsg.	Chk.	App.

CLIENT :-

THE EXECUTIVE ENGINEER, RDWS&S DIVISION
 Rural Drinking Water & Sanitation Department

SUPPORT AGENCY FOR :- SEAN ENGINEERS
 DPR PREPARATION No.36, IVth Cross, APC Layout,
 Thindlu Post, Vidyananyapura,
 Bangalore-560 097
 Ph: 080-23648988, Mob: 9448355094

PROJECT TITLE:-
 5 TPD MRF Facility at Hebri Gram Panchayat

DRAWING TITLE:-
 5 TPD MRF Facility at Hebri Gram Panchayat
 Layout Map

Date:- 24.09.2024	Drw. VS	Dsg. MN	Chk. PS	App. CHN	Scale. AS SHOWN	Drawing Status FOR SUBMISSION
----------------------	------------	------------	------------	-------------	--------------------	----------------------------------

Project No- DRG.NO: Sheet No-01 OF 10 Rev- Ro

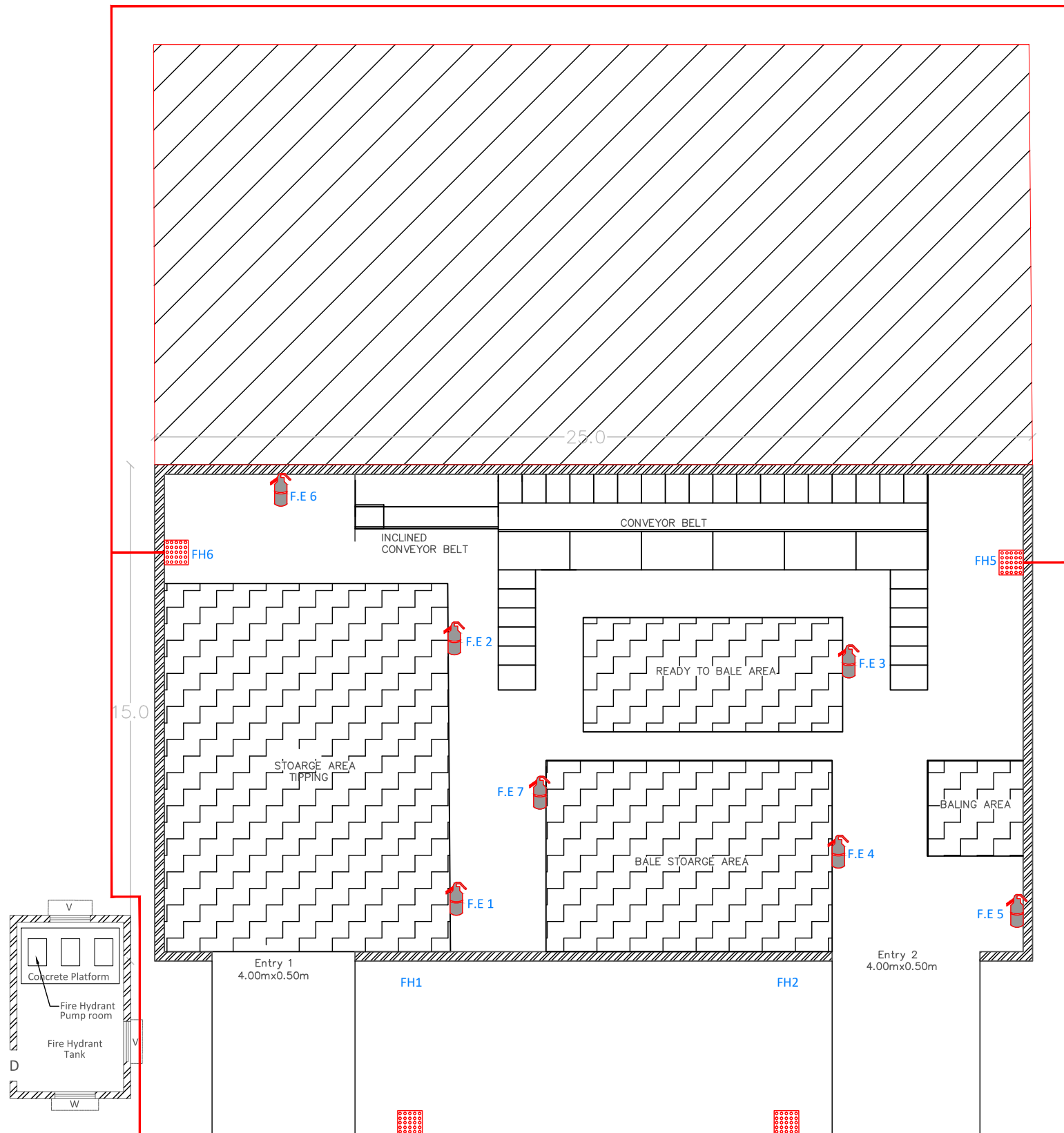

R0	FOR SUBMISSION	24.09.2024	VS	JV	PS	CHN
Rev.	Description.	Date	Drw.	Dsg.	Chk.	App.

CLIENT :-



THE EXECUTIVE ENGINEER, RDWS&S DIVISION
Rural Drinking Water & Sanitation Department

SUPPORT AGENCY FOR :-
DPR PREPARATION

SEAN ENGINEERS

No.36, IVth Cross, APC Layout,
Thindlu Post, Vidyaranyapura,
Bangalore-560 097
Ph: 080-23648988, Mob: 9448355094

PROJECT TITLE:-

5 TPD MRF Facility at Hebri Gram Panchayat

DRAWING TITLE:-

FIRE LAYOUT DETAILS

ITEMS	QUANTITY(No.)	SYMBOL
FIRE HYDRANT	12	
FIRE EXTINGUISHER	16	
FIRE PIPELINE	-	

Date:- 24.09.2024	Drw. VS	Dsg. MN	Chk. PS	App. CHN	Scale. AS SHOWN	Drawing Status FOR SUBMISSION
Project No-	DRG.NO:				Sheet No-03 OF 10	Rev- Ro

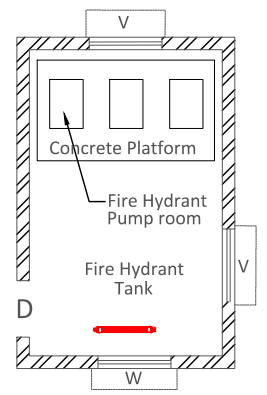
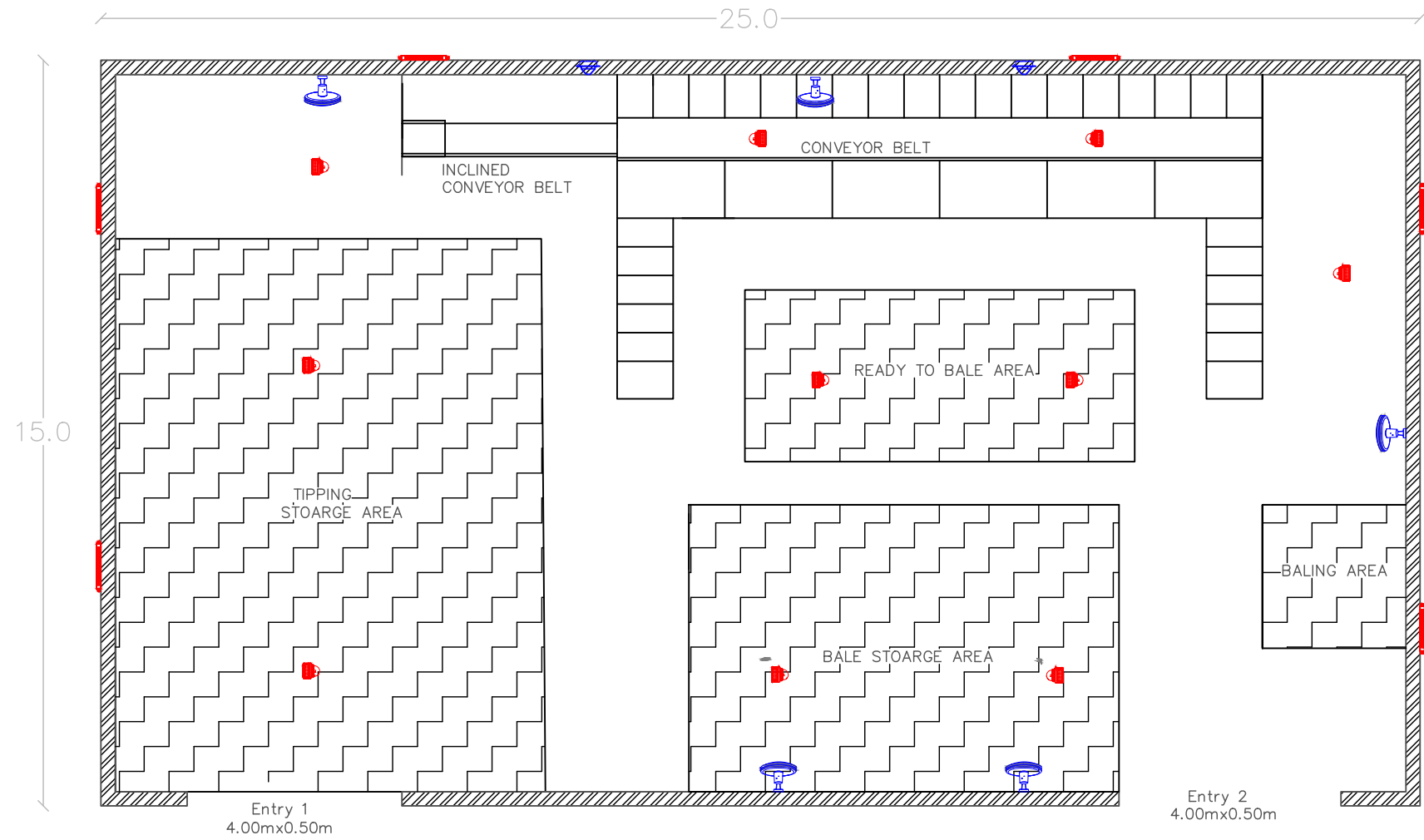
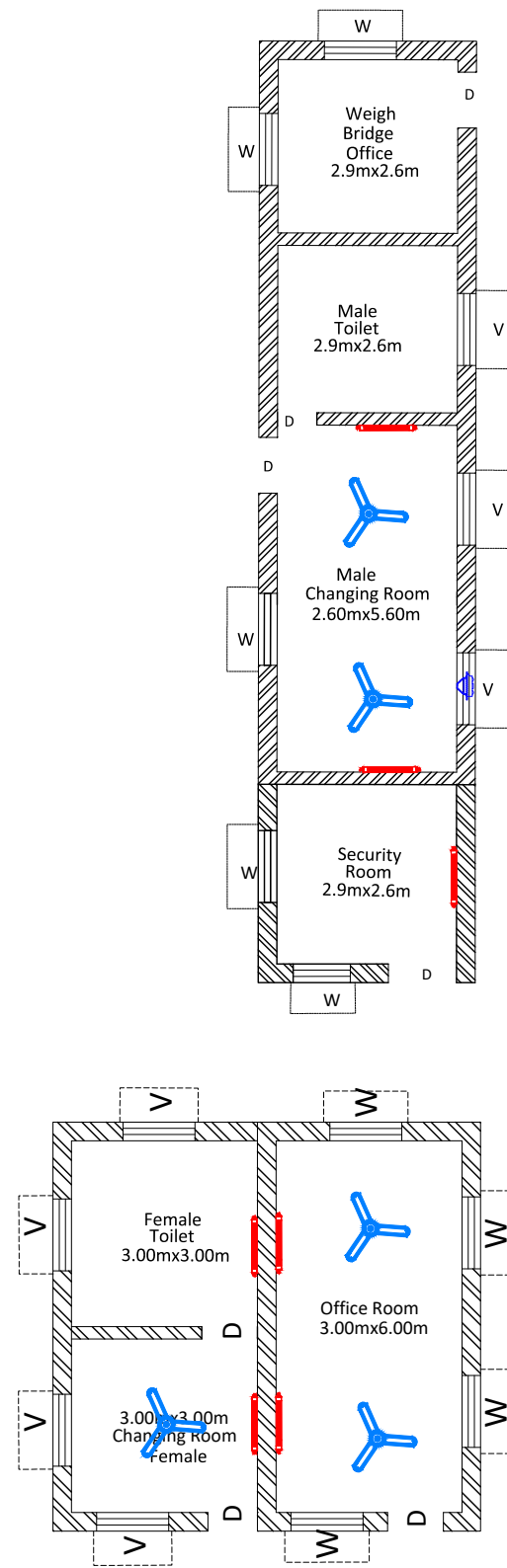
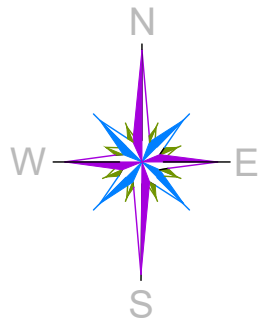

R0	FOR SUBMISSION	24.09.2024	VS	JV	PS	CHN
Rev.	Description.	Date	Drw.	Dsg.	Chk.	App.

PROJECT TITLE:-
5 TPD MRF Facility at Golihole Gram Panchayat







DRAWING TITLE:-
MRF ELECTRICAL MAP

CLIENT :-

THE EXECUTIVE ENGINEER, RDWS&S DIVISION
 Rural Drinking Water & Sanitation Department

SUPPORT AGENCY FOR :- **SEAN ENGINEERS**
 DPR PREPARATION
 No.36, IVth Cross, APC Layout,
 Thindlu Post, Vidyaranyapura,
 Bangalore-560 097
 Ph: 080-23648988, Mob: 9448355094

Date:- 24.09.2024	Drw. VS	Dsg. MN	Chk. PS	App. CHN	Scale. AS SHOWN	Drawing Status FOR SUBMISSION
Project No-	DRG.NO:				Sheet No-04 OF 10	Rev- Ro

SR. NO.	ITEMS	QUANTITY(NO.)	SYMBOL
01	STREET LIGHT (250W)	07	
02	LED LIGHT (100W)	10	
03	LED TUBE (24W)	22	
04	WALL MOUNTED FAN (180W)	05	
05	CELLING FAN (75W)	06	
06	TOILET EXHAUST FAN (60W)	08	

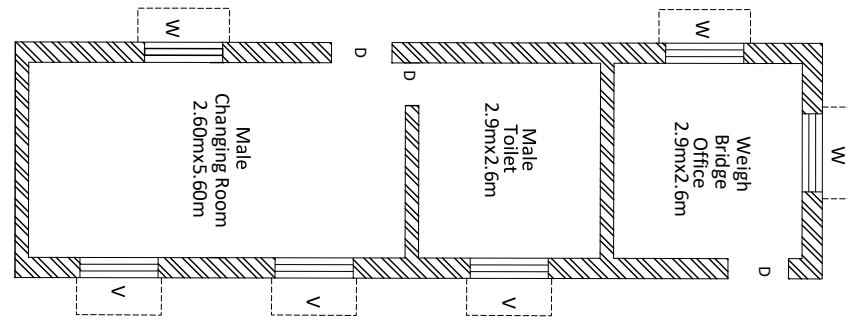
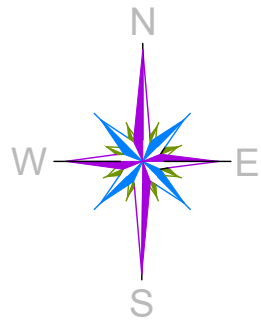

SECTIONAL ELEVATION @ A-A'

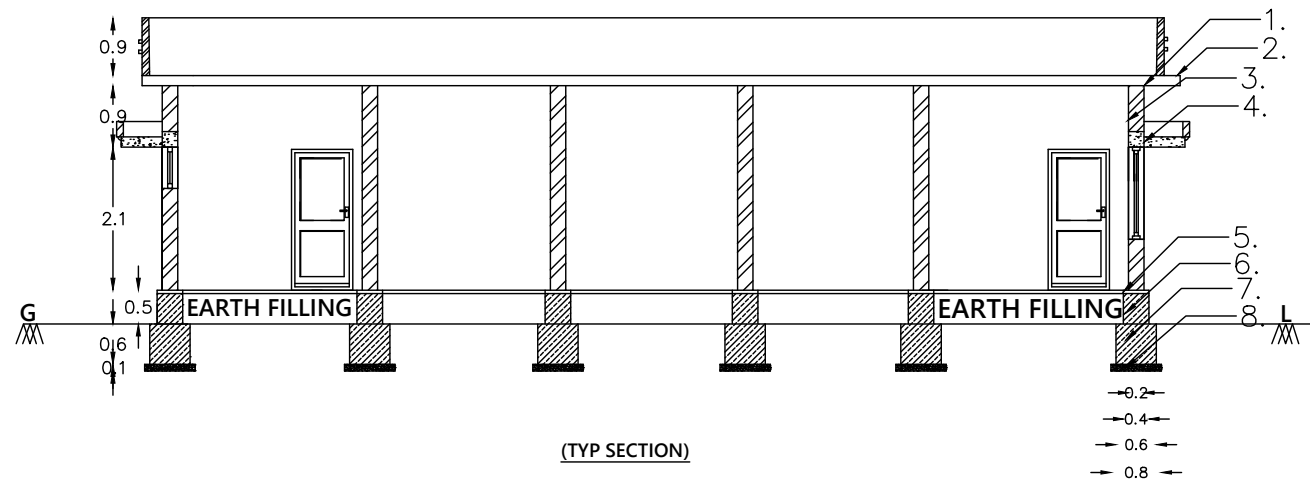
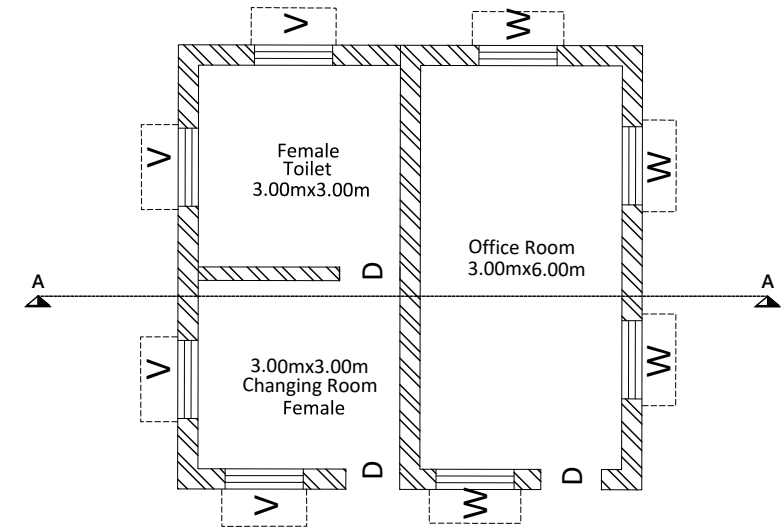

(TYP SECTION)

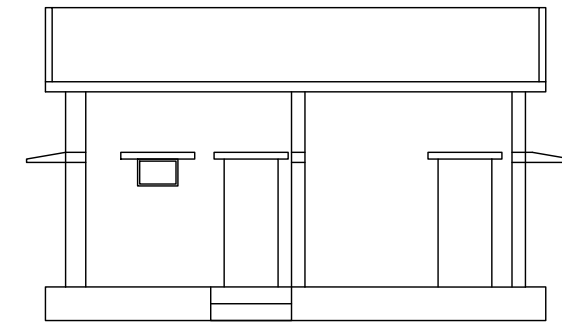

1. RCC ROOF SLAB IN C.C 1:1.5:3
2. PARAPET WALL USING C.B.M IN C.M 1:4
3. LATERITE STONE MASONRY IN C.M 1:6
(.23 THICK)
4. R.C.C SHADE WITH LINTEL IN C.C 1:1.5:3
5. D.P.C 1:3:6
6. S.S MASONRY FOR BASEMENT IN C.M 1:6
7. S.S MASONRY FOR FOUNDATION IN C.M 1:6
8. P.C.C BED IN C.C 1:4:8

Sl No	Particulars	No's	Dimension
01	Door	06	0.9m x 2.1m
01	Toilet Doors	03	0.8m x 2.1m
01	Window	08	1.5m x 1.2m
01	Ventilator	06	0.6m x 0.5m

R0	FOR SUBMISSION	24.09.2024	VS	JV	PS	CHN
Rev.	Description.	Date	Drw.	Dsg.	Chk.	App.
CLIENT :-  THE EXECUTIVE ENGINEER, RDWS&S DIVISION Rural Drinking Water & Sanitation Department						
SUPPORT AGENCY FOR :- SEAN ENGINEERS DPR PREPARATION No.36, IVth Cross, APC Layout, Thindlu Post, Vidyanarayapura, Bangalore-560 097 Ph: 080-23648988, Mob: 9448355094						

PROJECT TITLE:-						
5 TPD MRF FACILITY AT GOKARNA GRAM PANCHAYAT						
DRAWING TITLE:-						
OFFICE BUILDING PLAN & SECTION						
Date:- 24.09.2024	Drw. VS	Dsg. MN	Chk. PS	App. CHN	Scale. AS SHOWN	Drawing Status FOR SUBMISSION
Project No-	DRG.NO:				Sheet No-05 OF 10	Rev- Ro

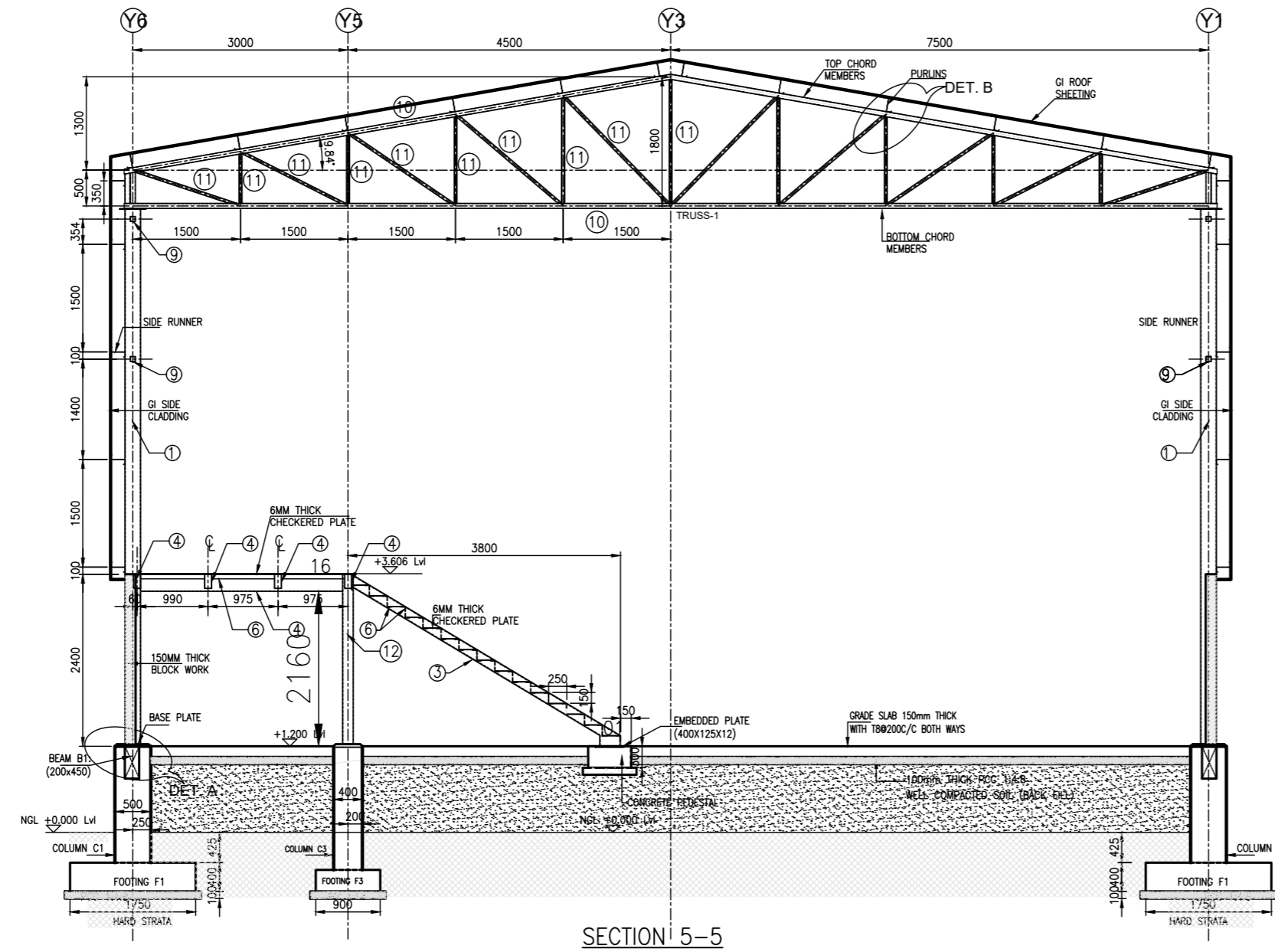

SECTION 5-5

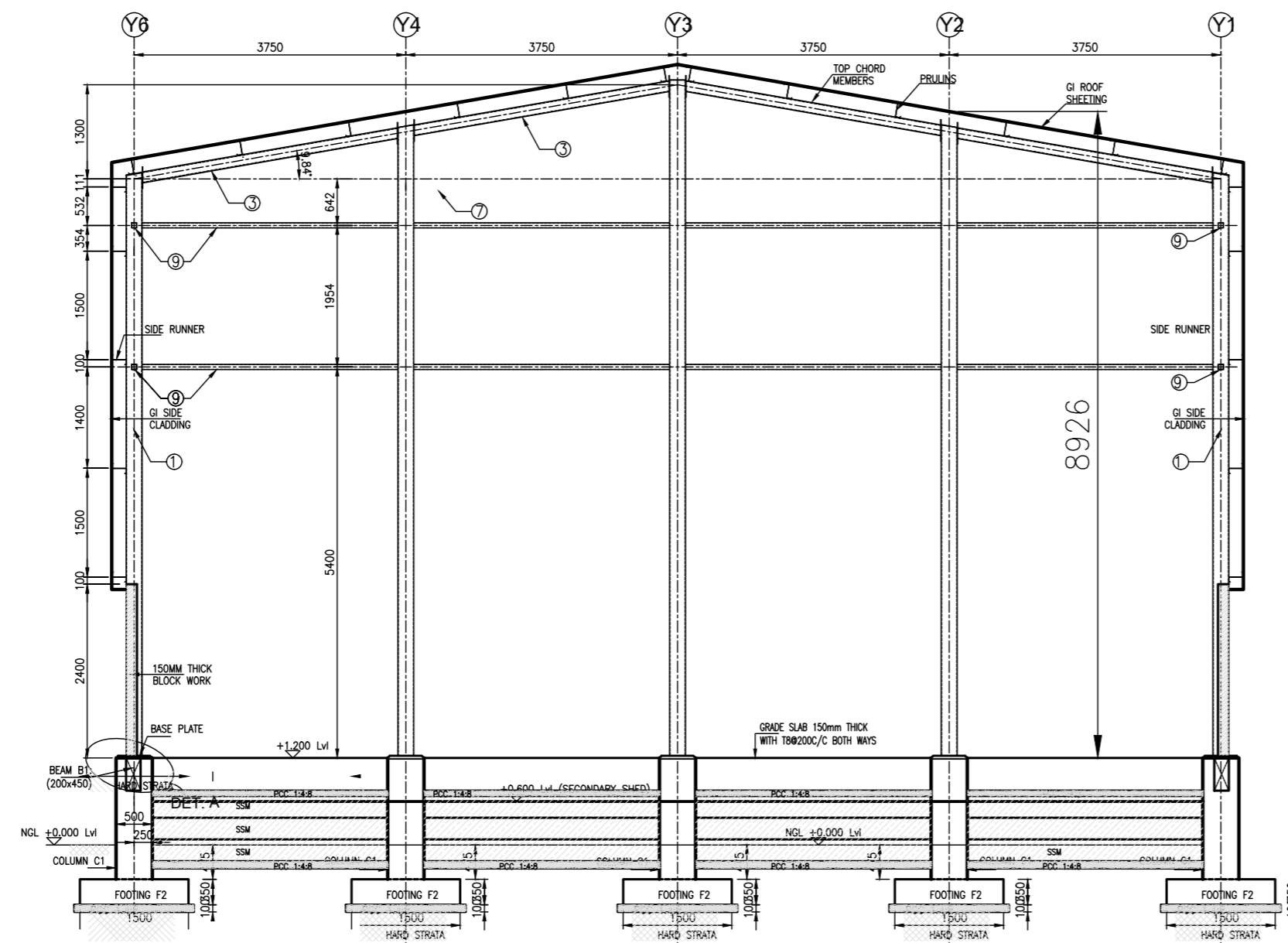

SECTION 6-6

NOTE:- a) SIDE RUNNERS AND GI SHEETING ARE NOT SHOWN
 b) MAXIMUM SPACING OF SIDE RUNNERS SHALL BE LESS THAN 1500MM UNLESS NOTED OTHERWISE

NOTES :-

1. ALL DIMENSIONS ARE IN METERS.
2. FOLLOW FIGURED DIMENSIONS ONLY, DO NOT SCALE THE DRAWING.
3. ALL LEVELS INDICATED ARE STRUCTURAL LEVELS UNLESS NOTED OTHERWISE.
4. CONCRETE SHALL BE OF GRADE M20.
5. GRADE OF STEEL SHALL BE Fe-500 CONFORMING TO IS:1786.
6. CLEAR COVER TO MAIN REINFORCEMENT SHALL BE:-
 a) FOOTING ---50MM b) COLUMN ---40MM
7. GRADE OF ALL STRUCTURAL STEEL SHALL BE E-250 CONFORMING TO IS: 2062.
8. ALL ELEVATIONS ARE TO THE TOP OF STEEL UNLESS OTHERWISE NOTED.
9. CONNECTION DETAILS SHOWN ARE INDICATIVE ONLY. SHOP DETAILS SHALL BE WORKED OUT TAKING INTO CONSIDERATION THE FORCES IN VARIOUS MEMBER.
10. CONNECTION OF ALL MEMBERS SHALL BE DESIGNED TO DEVELOP FULL TENSILE STRENGTH OF THE MEMBER UNLESS OTHERWISE NOTED.
11. MINIMUM WELD LENGTH SHALL BE 4MM UNLESS OTHERWISE NOTED AND MINIMUM SIZE OF GUSSET PL. SHALL BE 8MM.
12. MINIMUM WELD LENGTH SHALL BE 150MM UNLESS OTHERWISE NOTED.
13. ALL PERMANENT CONNECTIONS ARE WELDED CONNECTIONS UNLESS OTHERWISE NOTED.
14. ALL STRUCTURAL MEMBERS SHALL BE STRAIGHTENED, SAND BLAST TO CLEAN, RUST AND MILL SCALES BEFORE COMMENCEMENT OF FABRICATION.
15. BEFORE FINAL WELDING OF MEMBERS, ALL CENTRE TO CENTRE DISTANCE BETWEEN COLUMN/SUPPORTS AS EXECUTED SHALL BE MEASURED AND COMPARED WITH THEIR COUNTER PARTS IN DRAWINGS. ANY DISCREPANCY IN DIMENSIONS SHALL BE BROUGHT TO NOTICE OF CONSULTANTS AND SUITABLE MODIFICATIONS SHALL BE DONE.
16. ALL FABRICATION WORK SHALL CONFORM TO IS:800 TOLERANCE PERMISSIBLE SHALL BE AS PER TENDER SPECIFICATIONS AND IS:7215.
17. ALL FABRICATION WORK SHALL BE GOT APPROVED BY THE ENGINEER-IN-CHARGE BEFORE TAKING UP OF PAINTING WORK.
18. ALL STRUCTURAL STEEL WORK SHALL BE GIVEN ONE COAT OF RED OXIDE ZINC CHROMATE PRIMER IMMEDIATELY AFTER APPROVAL OF FABRICATION AND ONE MORE COAT OF THE SAME PAINT JUST BEFORE ERECTION. FINAL PAINTING SHALL BE DONE ON TOP OF PURLINS, CLADDING RUNNERS, UNDER SIDE SURFACE OF FLATS (WIND TIE) BEFORE LAYING THE ROOFING SHEETS. STEEL INSERT PLATES TO BE EMBEDDED IN R.C.C. WORK SHALL NOT BE PAINTED.
19. THE CONTRACTOR SHALL PROVIDE ADEQUATE LATERAL/VERTICAL SUPPORTS FOR ALL FABRICATED STRUCTURAL MEMBERS SUCH THAT PARTLY ERECTED STRUCTURE IS ALSO STABLE DURING GUST OF WIND. R.C.C. COL. IF ANY, SUPPORTING STRUCTURAL MEMBERS SHALL BE KEPT SUPPORTED LATERALLY, TILL ALL THE PERMANENT LATERAL MEMBERS ARE ADEQUATELY ANCHORED TO THE R.C.C. COLUMNS.
20. STITCH PLATE SHALL BE PROVIDED AT EVERY 600MM C/C FOR ALL THE MEMBERS.
21. THIS DRAWING HAS TO BE READ IN CONJUNCTION WITH ARCHITECTURAL/MECHANICAL DRAWING.
22. ANY DISCREPANCY IN THE DRAWING HAS TO BE BROUGHT TO NOTICE TO ENGINEER IN CHARGE BEFORE EXECUTION.

RO	FOR SUBMISSION	24.09.2024	VS	JV	PS	CHN
Rev.	Description.	Date	Drw.	Dsg.	Chk.	App.

CLIENT :-

THE EXECUTIVE ENGINEER, RDWS&S DIVISION
 Rural Drinking Water & Sanitation Department

SUPPORT AGENCY FOR :- SEAN ENGINEERS
 DPR PREPARATION No.36, IVth Cross, APC Layout,
 Thindlu Post, Vidyanayapura,
 Bangalore-560 097
 Ph: 080-23648988, Mob: 9448355094

PROJECT TITLE:-
 5 TPD MRF Facility at Hebri Gram Panchayat

DRAWING TITLE:-
 5 TPD MRF Facility at Hebri Gram Panchayat
 Primary & Secondary Shed Structural Details

Date:-	24.09.2024	Drw.	VS	Dsg.	MN	Chk.	PS	App.	CHN	Scale.	AS SHOWN	Drawing Status	FOR SUBMISSION
Project No-	DRG.NO:											Sheet No-07 OF 10	Rev- Ro

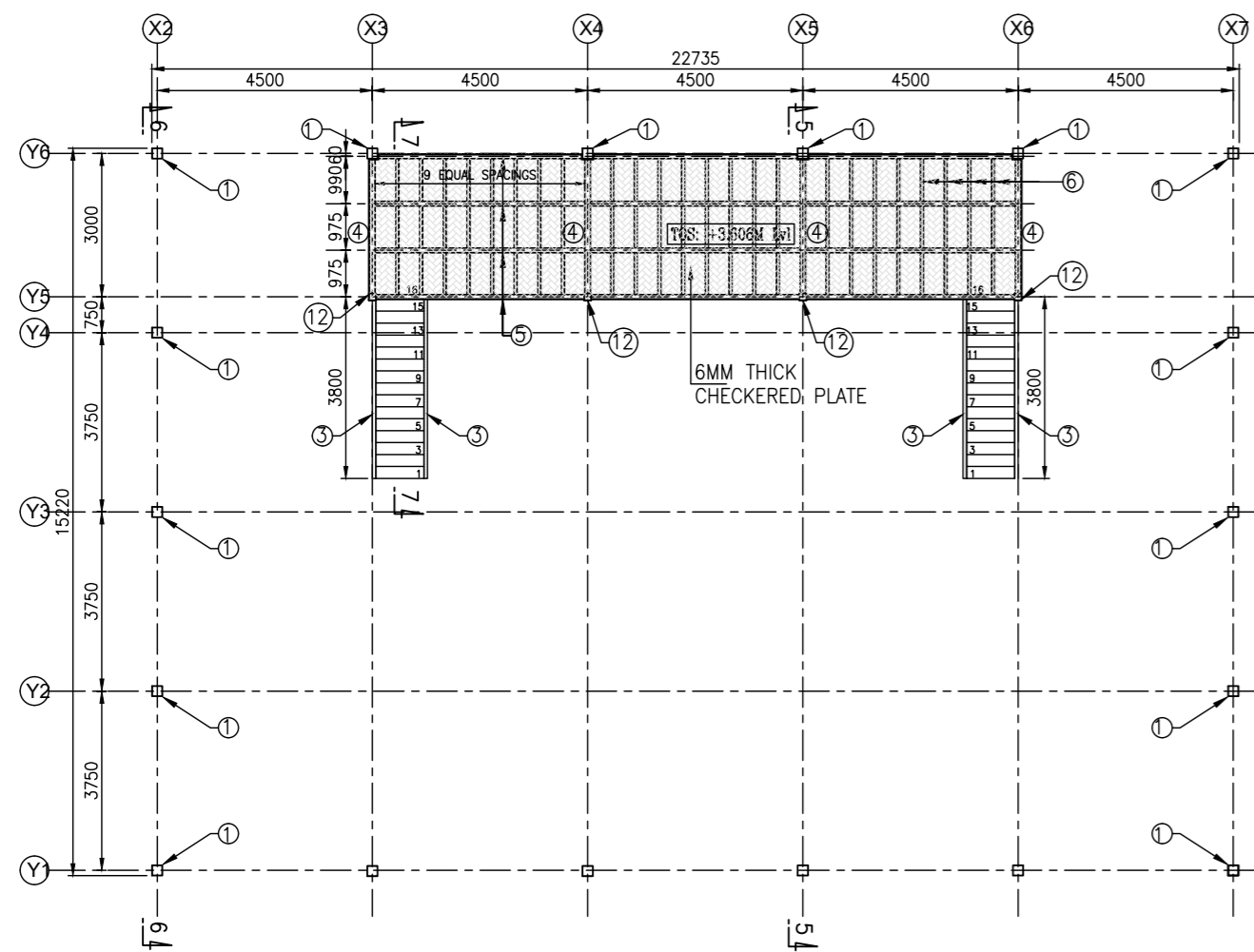

MEZZANINE FLOOR LAYOUT

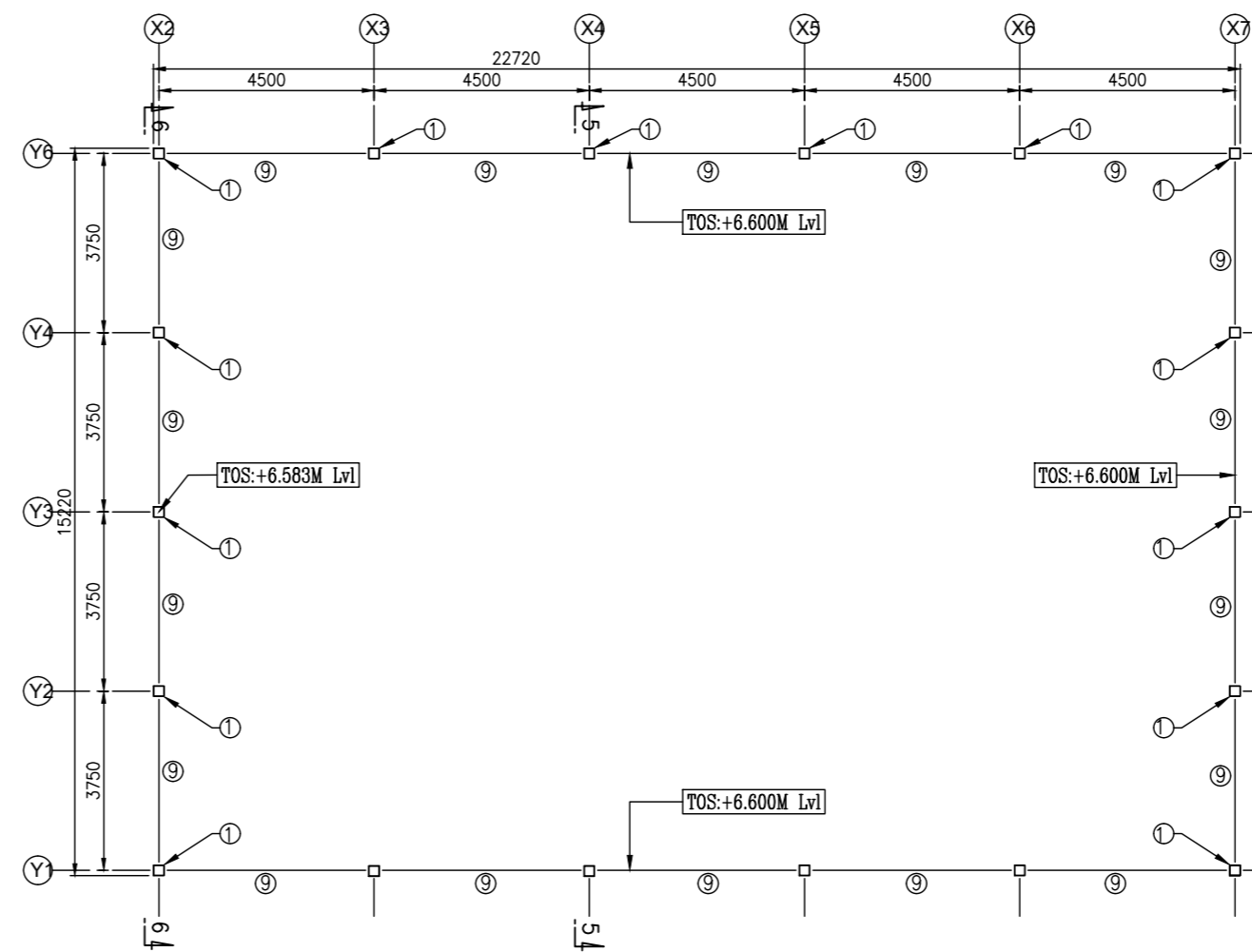

ROOF LAYOUT OF SECONDARY SHED

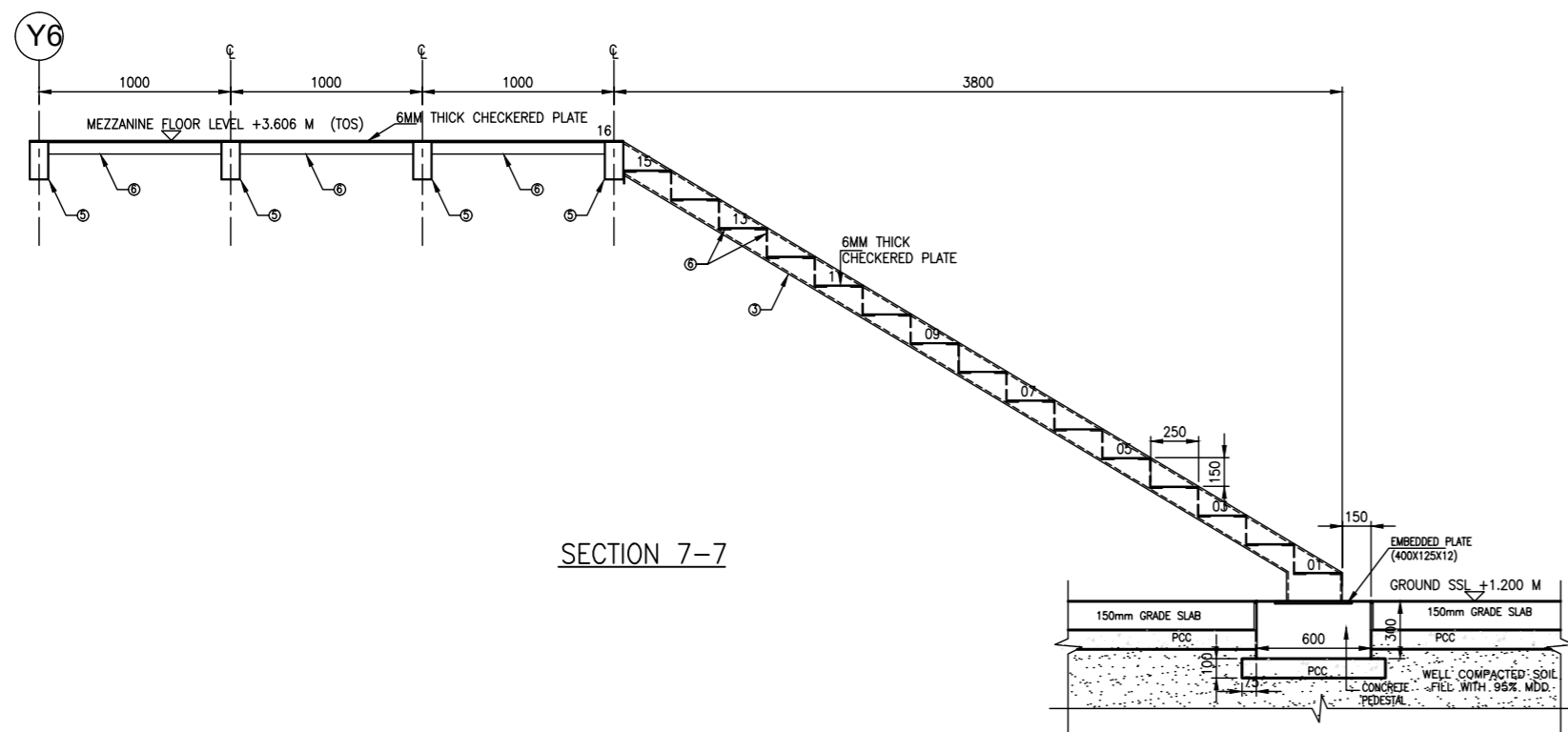

SECTION 7-7

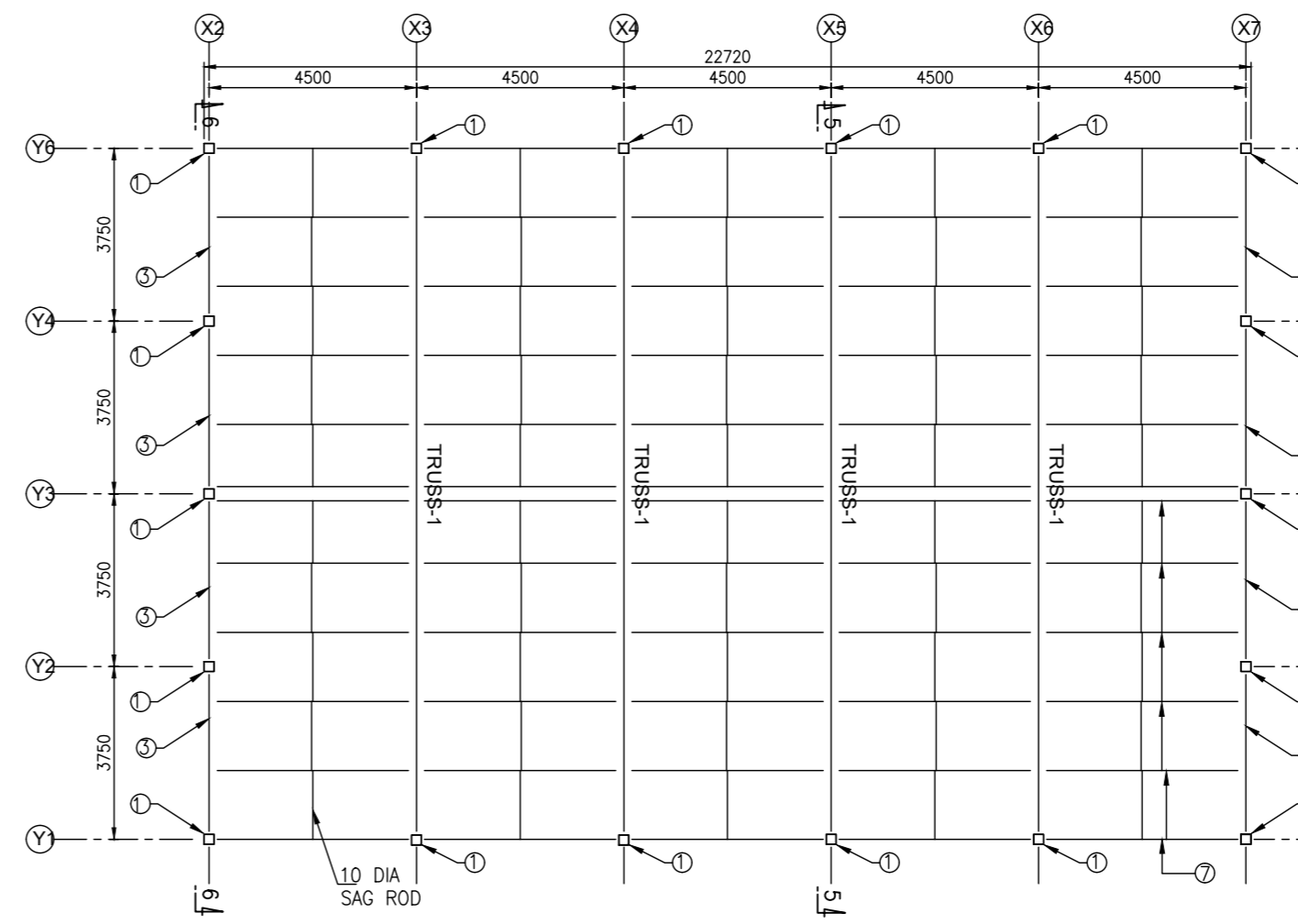

ROOF LAYOUT OF MAIN SHED

SCHEDULE OF MEMBERS

MEMBER MARKED	MEMBER SIZE	REMARKS
①	COLUMN RHS 220x220x6.0	
②	COLUMN SHS 100x100x5.0	
③	BEAM ISMC 150	
④	BEAM RHS 240x100x4.0	
⑤	BEAM RHS 200x100x4.0	
⑥	BEAM ISA 65x65x5.0	
⑦	PURLINS 200Z 2.5THK	
⑨	BEAM SHS 72x72x4.0	
⑩	TOP & BOTTOM CHORD MEMBERS SHS 72x72x4.0	
⑪	VERTICAL & INCLINED MEMBERS SHS 40x40x4.0	
⑫	COLUMN SHS 150x150x5.0	

NOTES :-

- ALL DIMENSIONS ARE IN METERS.
- FOLLOW FIGURED DIMENSIONS ONLY, DO NOT SCALE THE DRAWING.
- ALL LEVELS INDICATED ARE STRUCTURAL LEVELS UNLESS NOTED OTHERWISE.
- CONCRETE SHALL BE OF GRADE M20.
- GRADE OF STEEL SHALL BE F_y-500 CONFORMING TO IS:1786.
- CLEAR COVER TO MAIN REINFORCEMENT SHALL BE:-
a) FOOTING ---50MM b) COLUMN ---40MM
- GRADE OF ALL STRUCTURAL STEEL SHALL BE E-250 CONFORMING TO IS: 2062.
- ALL ELEVATIONS ARE TO THE TOP OF STEEL UNLESS OTHERWISE NOTED.
- CONNECTION DETAILS SHOWN ARE INDICATIVE ONLY. SHOP DETAILS SHALL BE WORKED OUT TAKING INTO CONSIDERATION THE FORCES IN VARIOUS MEMBER.
- CONNECTION OF ALL MEMBERS SHALL BE DESIGNED TO DEVELOP FULL TENSILE STRENGTH OF THE MEMBER UNLESS OTHERWISE NOTED.
- MINIMUM WELD SIZE SHALL BE 4MM UNLESS OTHERWISE NOTED AND MINIMUM SIZE OF GUSSET PL. SHALL BE 8MM.
- MINIMUM WELD LENGTH SHALL BE 150MM UNLESS OTHERWISE NOTED.
- ALL PERMANENT CONNECTIONS ARE WELDED CONNECTIONS UNLESS OTHERWISE NOTED.
- ALL STRUCTURAL MEMBERS SHALL BE STRAIGHTENED, SAND BLAST TO CLEAN, RUST AND MILL SCALES BEFORE COMMENCEMENT OF FABRICATION.
- BEFORE FINAL WELDING OF MEMBERS, ALL CENTRE TO CENTRE DISTANCE BETWEEN COLUMN/SUPPORTS AS EXECUTED SHALL BE MEASURED AND COMPARED WITH THEIR COUNTER PARTS IN DRAWINGS. ANY DISCREPANCY IN DIMENSIONS SHALL BE BROUGHT TO NOTICE OF CONSULTANTS AND SUITABLE MODIFICATIONS SHALL BE DONE.
- ALL FABRICATION WORK SHALL CONFORM TO IS:800 TOLERANCE PERMISSIBLE SHALL BE AS PER TENDER SPECIFICATIONS AND IS:7215.
- ALL FABRICATION WORK SHALL BE GOT APPROVED BY THE ENGINEER-IN-CHARGE BEFORE TAKING UP OF PAINTING WORK.
- ALL STRUCTURAL STEEL WORK SHALL BE GIVEN ONE COAT OF RED OXIDE ZINC CHROMATE PRIMER IMMEDIATELY AFTER APPROVAL OF FABRICATION AND ONE MORE COAT OF THE SAME PAINT JUST BEFORE ERECTION. FINAL PAINTING SHALL BE DONE ON TOP OF PURLINS, CLADDING RUNNERS, UNDER SIDE SURFACE OF FLATS (WIND TIE) BEFORE LAYING THE ROOFING SHEETS. STEEL INSERT PLATES TO BE EMBEDDED IN R.C.C. WORK SHALL NOT BE PAINTED.
- THE CONTRACTOR SHALL PROVIDE ADEQUATE LATERAL/VERTICAL SUPPORTS FOR ALL FABRICATED STRUCTURAL MEMBERS SUCH THAT PARTLY ERECTED STRUCTURE IS ALSO STABLE DURING DUST OF WIND. R.C.C. COL. IF ANY, SUPPORTING STRUCTURAL MEMBERS SHALL BE KEPT SUPPORTED LATERALLY, TILL ALL THE PERMANENT LATERAL MEMBERS ARE ADEQUATELY ANCHORED TO THE R.C.C. COLUMNS.
- STITCH PLATE SHALL BE PROVIDED AT EVERY 600MM C/C FOR ALL THE MEMBERS.
- THIS DRAWING HAS TO BE READ IN CONJUNCTION WITH ARCHITECTURAL/MECHANICAL DRAWING.
- ANY DISCREPANCY IN THE DRAWING HAS TO BE BROUGHT TO NOTICE TO ENGINEER IN CHARGE BEFORE EXECUTION.

R0	FOR SUBMISSION	24.09.2024	VS	JV	PS	CHN
Rev.	Description.	Date	Drw.	Dsg.	Chk.	App.

CLIENT :-

THE EXECUTIVE ENGINEER, RDWS&S DIVISION
 Rural Drinking Water & Sanitation Department

SUPPORT AGENCY FOR :- SEAN ENGINEERS
 DPR PREPARATION No.36, IVth Cross, APC Layout,
 Thindlu Post, Vidyaranyapura,
 Bangalore-560 097
 Ph: 080-23648988, Mob: 9448355094

PROJECT TITLE:-
 5 TPD MRF Facility at Hebri Gram Panchayat

DRAWING TITLE:-
 5 TPD MRF Facility at Hebri Gram Panchayat
 Primary Shed Structural Details

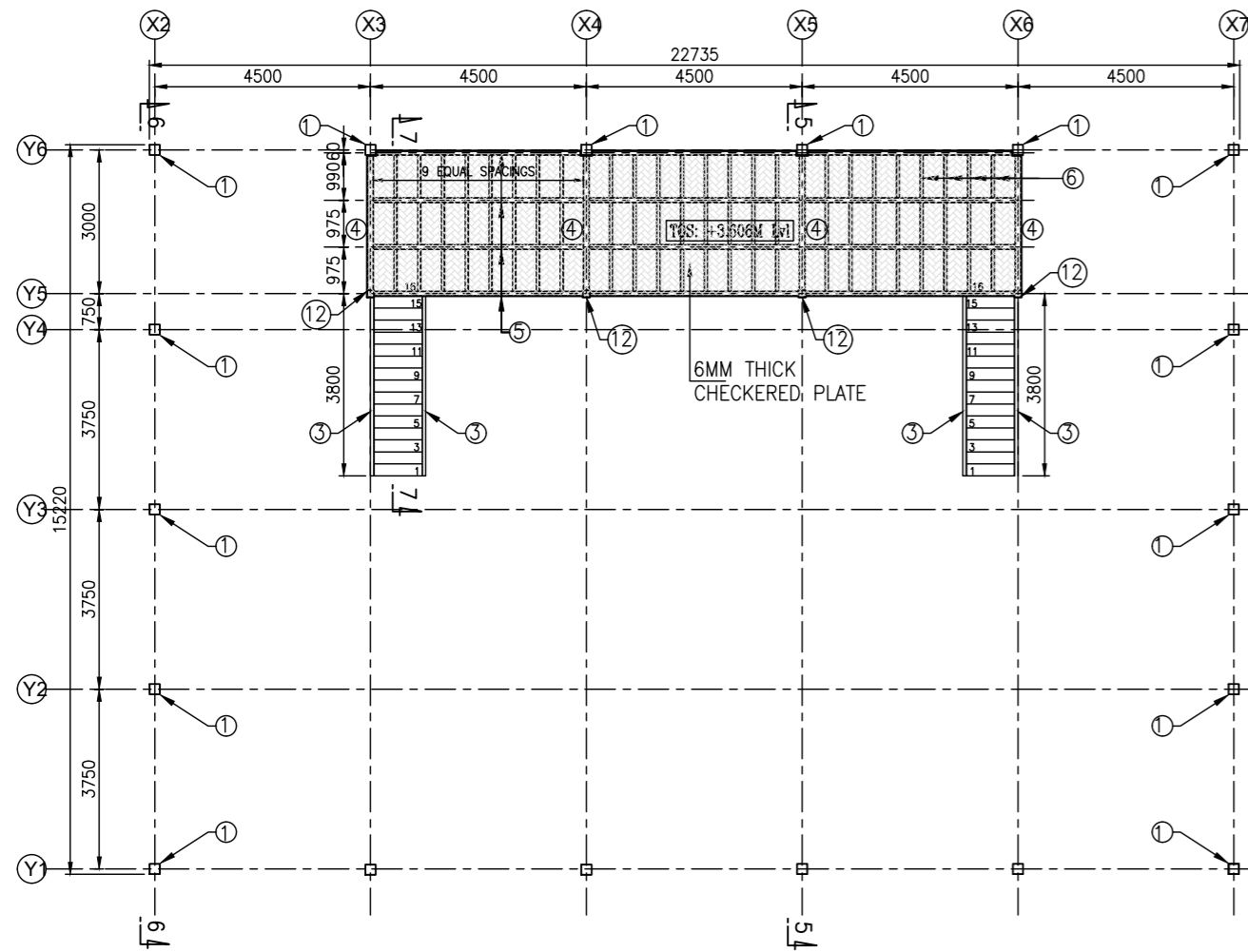
Date:-	24.09.2024	Drw.	VS	Dsg.	MN	Chk.	PS	App.	CHN	Scale.	AS SHOWN	Drawing Status	FOR SUBMISSION
Project No-	DRG.NO:									Sheet No-	08 OF 10	Rev-	Ro



MEZZANINE FLOOR LAYOUT

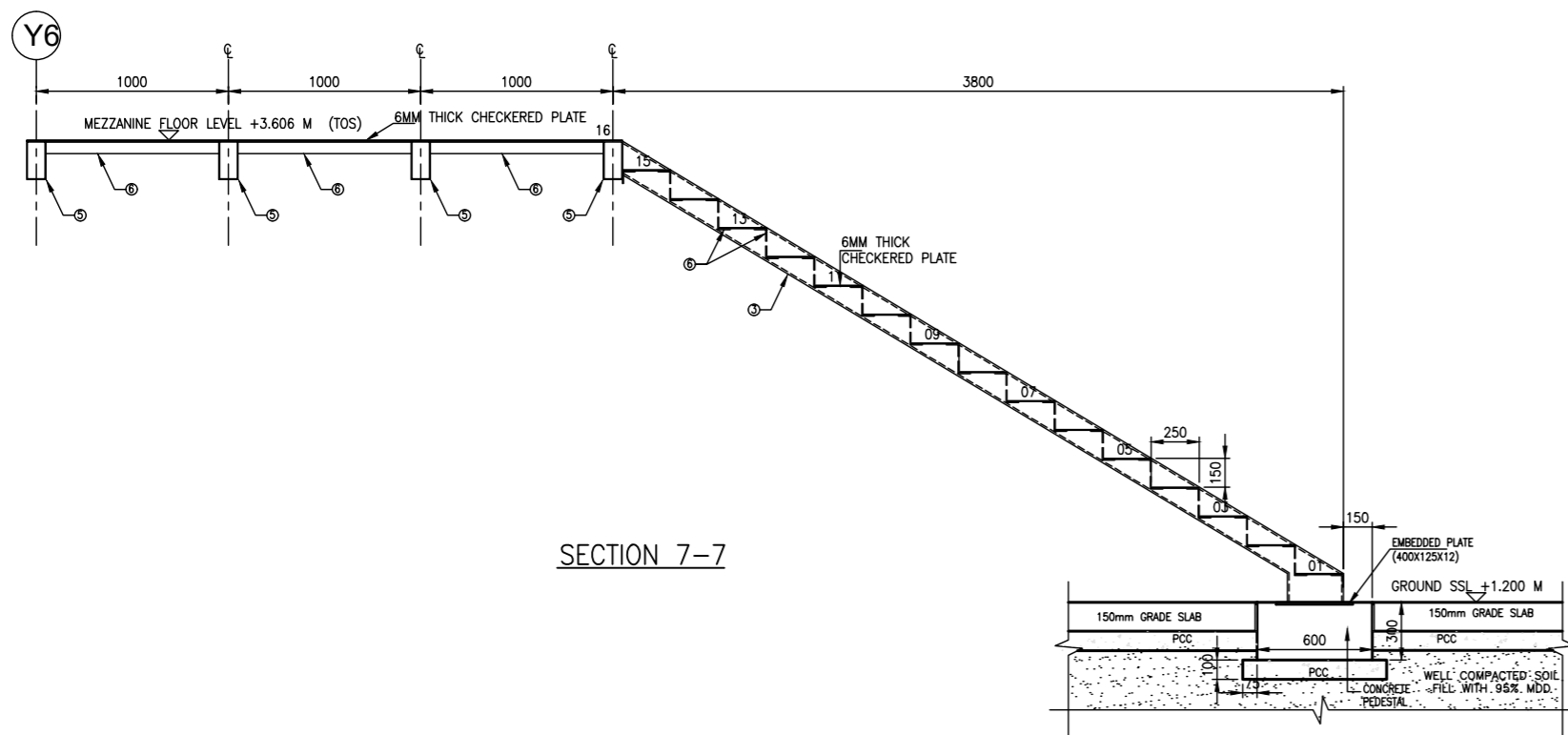

SECTION 7-7

SCHEDULE OF MEMBERS

MEMBER MARKED	MEMBER SIZE	REMARKS
①	COLUMN RHS 220x220x6.0	⊠
②	COLUMN SHS 100x100x5.0	⊠
③	BEAM ISMC 150	⊠
④	BEAM RHS 240x100x4.0	⊠
⑤	BEAM RHS 200x100x4.0	⊠
⑥	BEAM ISA 65x65x5.0	⊠
⑦	PURLINS 200Z 2.5THK	⊠
⑨	BEAM SHS 72x72x4.0	⊠
⑩	TOP & BOTTOM CHORD MEMBERS SHS 72x72x4.0	⊠
⑪	VERTICAL & INCLINED MEMBERS SHS 40x40x4.0	⊠
⑫	COLUMN SHS 150x150x5.0	⊠

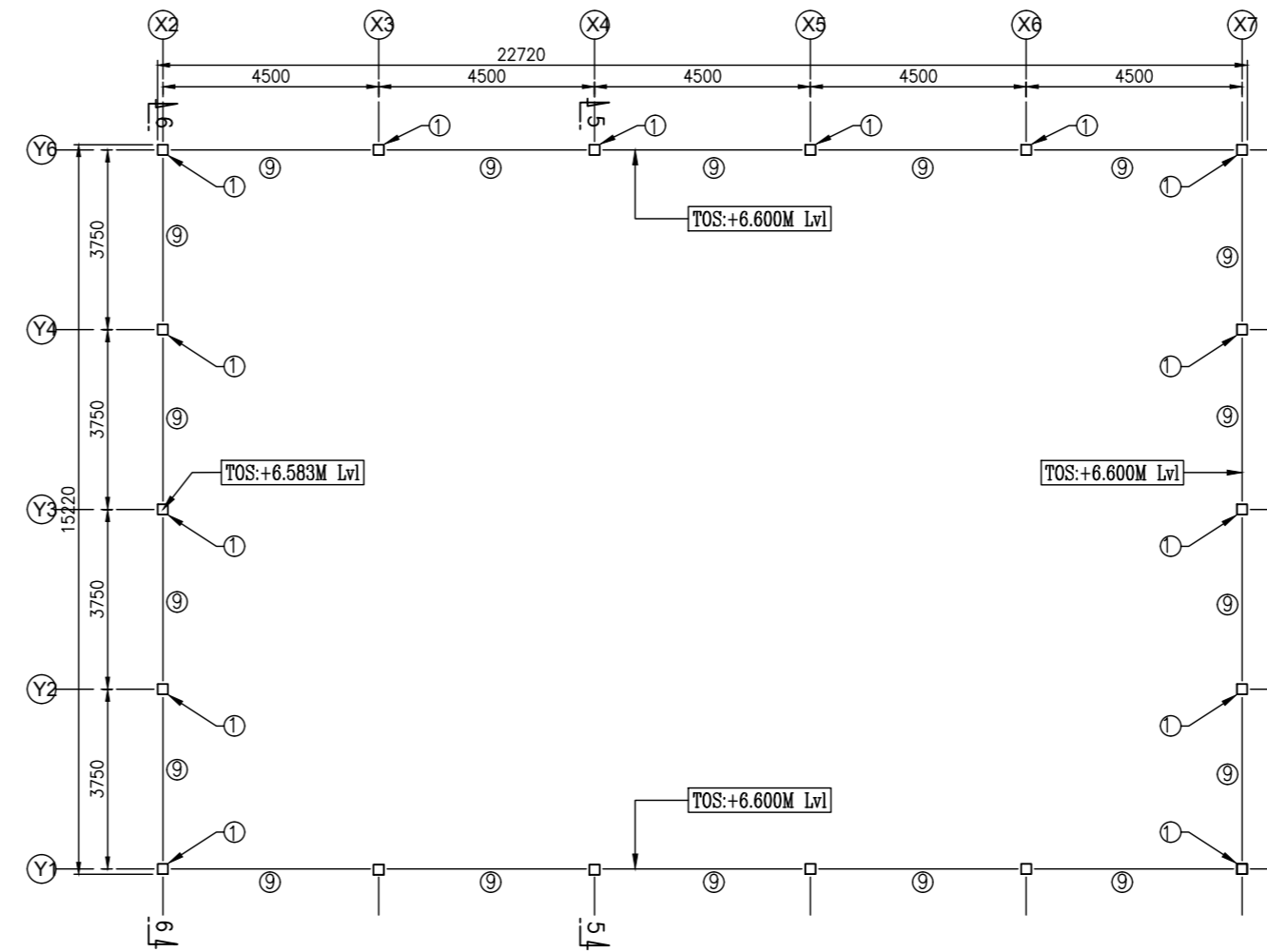

ROOF LAYOUT OF SECONDARY SHED

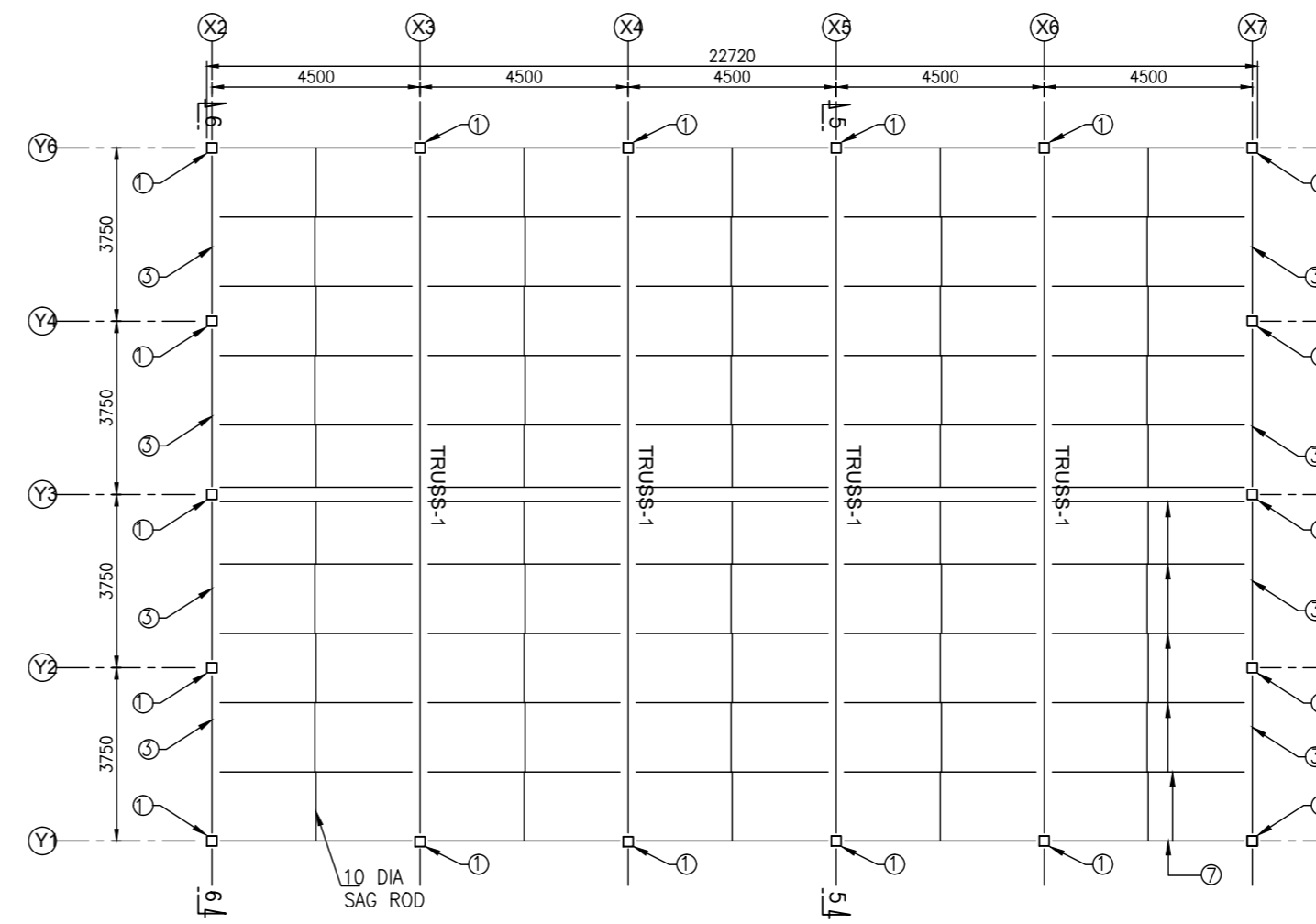

ROOF LAYOUT OF MAIN SHED

- NOTES :-
1. ALL DIMENSIONS ARE IN METERS.
 2. FOLLOW FIGURED DIMENSIONS ONLY, DO NOT SCALE THE DRAWING.
 3. ALL LEVELS INDICATED ARE STRUCTURAL LEVELS UNLESS NOTED OTHERWISE.
 4. CONCRETE SHALL BE OF GRADE M20.
 5. GRADE OF STEEL SHALL BE F_y-500 CONFORMING TO IS:1786.
 6. CLEAR COVER TO MAIN REINFORCEMENT SHALL BE:-
a) FOOTING ---50MM b) COLUMN ---40MM
 7. GRADE OF ALL STRUCTURAL STEEL SHALL BE E-250 CONFORMING TO IS: 2062.
 8. ALL ELEVATIONS ARE TO THE TOP OF STEEL UNLESS OTHERWISE NOTED.
 9. CONNECTION DETAILS SHOWN ARE INDICATIVE ONLY. SHOP DETAILS SHALL BE WORKED OUT TAKING INTO CONSIDERATION THE FORCES IN VARIOUS MEMBER.
 10. CONNECTION OF ALL MEMBERS SHALL BE DESIGNED TO DEVELOP FULL TENSILE STRENGTH OF THE MEMBER UNLESS OTHERWISE NOTED.
 11. MINIMUM WELD LENGTH SHALL BE 4MM UNLESS OTHERWISE NOTED AND MINIMUM SIZE OF GUSSET PL. SHALL BE 8MM.
 12. MINIMUM WELD LENGTH SHALL BE 150MM UNLESS OTHERWISE NOTED.
 13. ALL PERMANENT CONNECTIONS ARE WELDED CONNECTIONS UNLESS OTHERWISE NOTED.
 14. ALL STRUCTURAL MEMBERS SHALL BE STRAIGHTENED, SAND BLAST TO CLEAN, RUST AND MILL SCALES BEFORE COMMENCEMENT OF FABRICATION.
 15. BEFORE FINAL WELDING OF MEMBERS, ALL CENTRE TO CENTRE DISTANCE BETWEEN COLUMN/SUPPORTS AS EXECUTED SHALL BE MEASURED AND COMPARED WITH THEIR COUNTER PARTS IN DRAWINGS. ANY DISCREPANCY IN DIMENSIONS SHALL BE BROUGHT TO NOTICE OF CONSULTANTS AND SUITABLE MODIFICATIONS SHALL BE DONE.
 16. ALL FABRICATION WORK SHALL CONFORM TO IS:800 TOLERANCE PERMISSIBLE SHALL BE AS PER TENDER SPECIFICATIONS AND IS:7215.
 17. ALL FABRICATION WORK SHALL BE GOT APPROVED BY THE ENGINEER-IN-CHARGE BEFORE TAKING UP OF PAINTING WORK.
 18. ALL STRUCTURAL STEEL WORK SHALL BE GIVEN ONE COAT OF RED OXIDE ZINC CHROMATE PRIMER IMMEDIATELY AFTER APPROVAL OF FABRICATION AND ONE MORE COAT OF THE SAME PAINT JUST BEFORE ERECTION. FINAL PAINTING SHALL BE DONE ON TOP OF PURLINE, CLADDING RUNNERS, UNDER SIDE SURFACE OF FLATS (WIND TIE) BEFORE LAYING THE ROOFING SHEETS. STEEL INSERT PLATES TO BE EMBEDDED IN R.C.C. WORK SHALL NOT BE PAINTED.
 19. THE CONTRACTOR SHALL PROVIDE ADEQUATE LATERAL/VERTICAL SUPPORTS FOR ALL FABRICATED STRUCTURAL MEMBERS SUCH THAT PARTLY ERECTED STRUCTURE IS ALSO STABLE DURING GUST OF WIND. R.C.C. COL. IF ANY, SUPPORTING STRUCTURAL MEMBERS SHALL BE KEPT SUPPORTED LATERALLY, TILL ALL THE PERMANENT LATERAL MEMBERS ARE ADEQUATELY ANCHORED TO THE R.C.C. COLUMNS.
 20. STITCH PLATE SHALL BE PROVIDED AT EVERY 600MM C/C FOR ALL THE MEMBERS.
 21. THIS DRAWING HAS TO BE READ IN CONJUNCTION WITH ARCHITECTURAL/MECHANICAL DRAWING.
 22. ANY DISCREPANCY IN THE DRAWING HAS TO BE BROUGHT TO NOTICE TO ENGINEER IN CHARGE BEFORE EXECUTION.

Rev.	Description.	Date	Drw.	Dsg.	Chk.	App.
RO	FOR SUBMISSION	24.09.2024	VS	JV	PS	CHN

CLIENT :-
THE EXECUTIVE ENGINEER, RDWS&S DIVISION
 Rural Drinking Water & Sanitation Department

SUPPORT AGENCY FOR :- SEAN ENGINEERS
 DPR PREPARATION No.36, IVth Cross, APC Layout,
 Thindlu Post, Vidyanayapura,
 Bangalore-560 097
 Ph: 080-23648988, Mob: 9448355094

PROJECT TITLE:-
 5 TPD MRF Facility at Hebri Gram Panchayat

DRAWING TITLE:-
 5 TPD MRF Facility at Hebri Gram Panchayat
 Primary Shed Structural Details

Date:-	Drw.	Dsg.	Chk.	App.	Scale	Drawing Status
24.09.2024	VS	MN	PS	CHN	AS SHOWN	FOR SUBMISSION

Project No- DRG.NO: Sheet No-09 OF 10 Rev- Ro

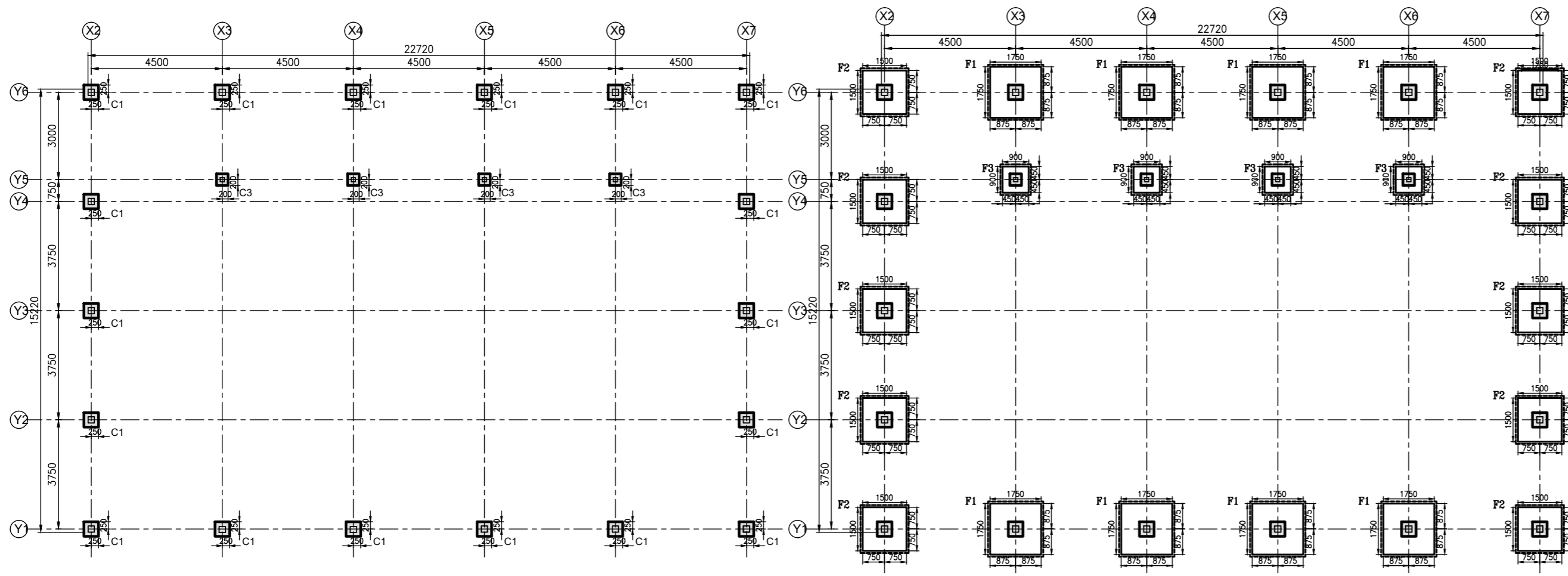

COLUMN LAYOUT

FOOTING LAYOUT

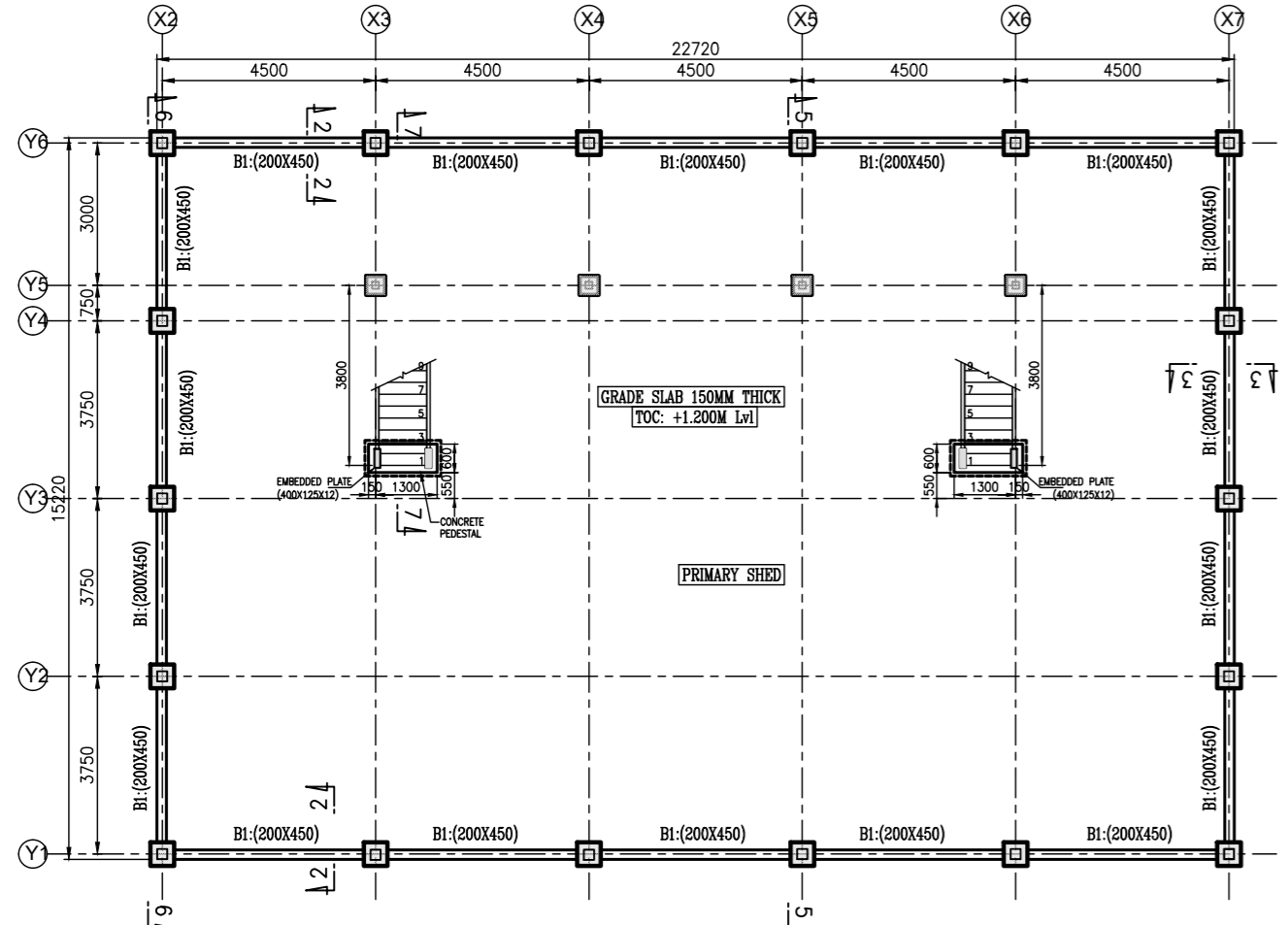

PLINTH BEAM LAYOUT

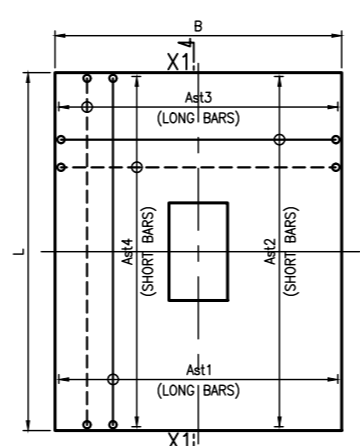

PLAN OF ISOLATED FOOTING

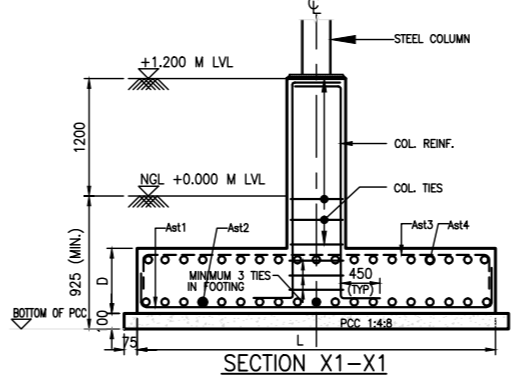

SECTION X1-X1

COLUMN SCHEDULE

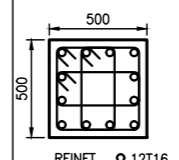
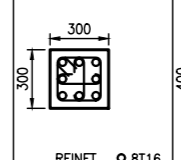
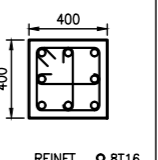
COLUMN TYPE:	UP TO GROUND FLOOR		
	C1	C2	C3
	 REINFT. : 12T16 LINKS : T8-150	 REINFT. : 8T16 LINKS : T8-150	 REINFT. : 8T16 LINKS : T8-150

FOOTING TYPE	DIMENSIONS			REINFORCEMENT				REMARKS
	L	B	D	BOTTOM REINFORCEMENT		TOP REINFORCEMENT		
				Ast1 (LONG BARS)	Ast2 (SHORT BARS)	Ast1 (LONG BARS)	Ast2 (SHORT BARS)	
F1	1750	1750	400	T10-150	T10-150	T8-150	T8-150	FOUNDATION IS DESIGNED FOR AN SBC OF 125kN/sqm @ A DEPTH OF 925mm FROM NGL
F2	1500	1500	350	T10-150	T10-150	T8-150	T8-150	
F3	900	900	300	T8-150	T8-150	----	----	

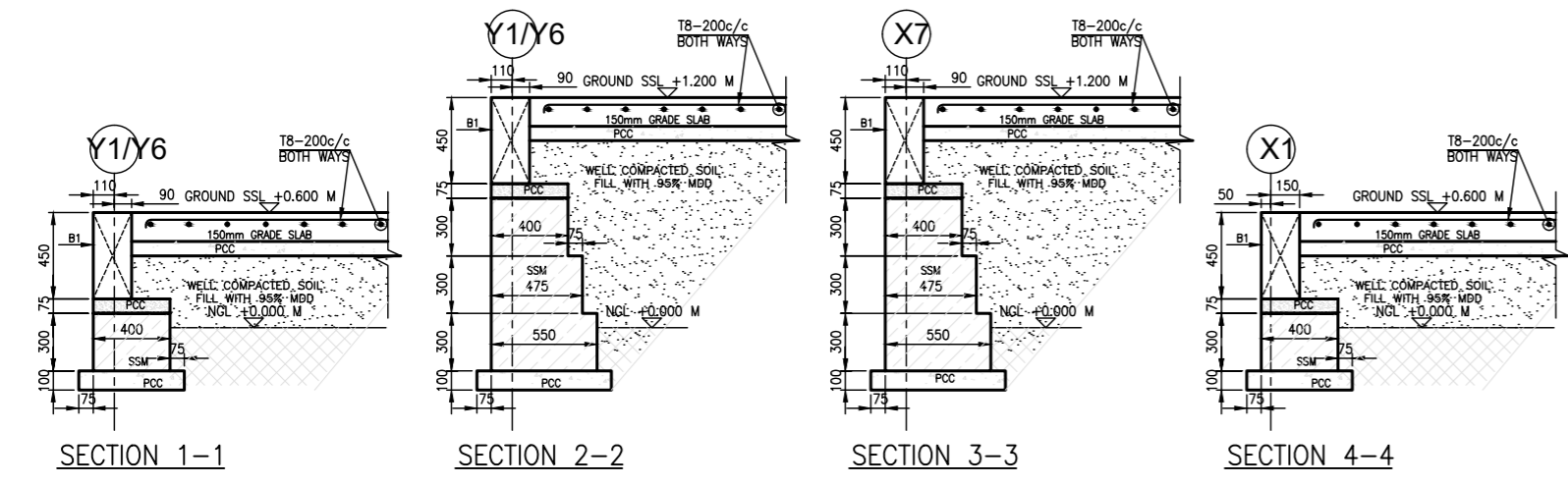

- NOTES :-
- ALL DIMENSIONS ARE IN METERS.
 - FOLLOW FIGURED DIMENSIONS ONLY, DO NOT SCALE THE DRAWING.
 - ALL LEVELS INDICATED ARE STRUCTURAL LEVELS UNLESS NOTED OTHERWISE.
 - CONCRETE SHALL BE OF GRADE M20.
 - GRADE OF STEEL SHALL BE Fe-500 CONFORMING TO IS:1786.
 - CLEAR COVER TO MAIN REINFORCEMENT SHALL BE:-
a) FOOTING ---50MM b) COLUMN ---40MM
 - GRADE OF ALL STRUCTURAL STEEL SHALL BE E-250 CONFORMING TO IS: 2062.
 - ALL ELEVATIONS ARE TO THE TOP OF STEEL UNLESS OTHERWISE NOTED.
 - CONNECTION DETAILS SHOWN ARE INDICATIVE ONLY. SHOP DETAILS SHALL BE WORKED OUT TAKING INTO CONSIDERATION THE FORCES IN VARIOUS MEMBER.
 - CONNECTION OF ALL MEMBERS SHALL BE DESIGNED TO DEVELOP FULL TENSILE STRENGTH OF THE MEMBER UNLESS OTHERWISE NOTED.
 - MINIMUM WELD LENGTH SHALL BE 4MM UNLESS OTHERWISE NOTED AND MINIMUM SIZE OF GUSSET PL. SHALL BE 8MM.
 - MINIMUM WELD LENGTH SHALL BE 150MM UNLESS OTHERWISE NOTED.
 - ALL PERMANENT CONNECTIONS ARE WELDED CONNECTIONS UNLESS OTHERWISE NOTED.
 - ALL STRUCTURAL MEMBERS SHALL BE STRAIGHTENED, SAND BLAST TO CLEAN, RUST AND MILL SCALES BEFORE COMMENCEMENT OF FABRICATION.
 - BEFORE FINAL WELDING OF MEMBERS, ALL CENTRE TO CENTRE DISTANCE BETWEEN COLUMN/SUPPORTS AS EXECUTED SHALL BE MEASURED AND COMPARED WITH THEIR COUNTER PARTS IN DRAWINGS. ANY DISCREPANCY IN DIMENSIONS SHALL BE BROUGHT TO NOTICE OF CONSULTANTS AND SUITABLE MODIFICATIONS SHALL BE DONE.
 - ALL FABRICATION WORK SHALL CONFORM TO IS:800 TOLERANCE PERMISSIBLE SHALL BE AS PER TENDER SPECIFICATIONS AND IS:7215.
 - ALL FABRICATION WORK SHALL BE GOT APPROVED BY THE ENGINEER-IN-CHARGE BEFORE TAKING UP OF PAINTING WORK.
 - ALL STRUCTURAL STEEL WORK SHALL BE GIVEN ONE COAT OF RED OXIDE ZINC CHROMATE PRIMER IMMEDIATELY AFTER APPROVAL OF FABRICATION AND ONE MORE COAT OF THE SAME PAINT JUST BEFORE ERECTION. FINAL PAINTING SHALL BE DONE ON TOP OF PURLINE, CLADDING RUNNERS, UNDER SIDE SURFACE OF FLATS (WIND TIE) BEFORE LAYING THE ROOFING SHEETS. STEEL INSERT PLATES TO BE EMBEDDED IN R.C.C. WORK SHALL NOT BE PAINTED.
 - THE CONTRACTOR SHALL PROVIDE ADEQUATE LATERAL/VERTICAL SUPPORTS FOR ALL FABRICATED STRUCTURAL MEMBERS SUCH THAT PARTLY ERECTED STRUCTURE IS ALSO STABLE DURING DUST OF WIND. R.C.C. COL. IF ANY, SUPPORTING STRUCTURAL MEMBERS SHALL BE KEPT SUPPORTED LATERALLY, TILL ALL THE PERMANENT LATERAL MEMBERS ARE ADEQUATELY ANCHORED TO THE R.C.C. COLUMNS.
 - STITCH PLATE SHALL BE PROVIDED AT EVERY 600MM C/C FOR ALL THE MEMBERS.
 - THIS DRAWING HAS TO BE READ IN CONJUNCTION WITH ARCHITECTURAL/MECHANICAL DRAWING.
 - ANY DISCREPANCY IN THE DRAWING HAS TO BE BROUGHT TO NOTICE TO ENGINEER IN CHARGE BEFORE EXECUTION.

Rev.	Description.	Date	Drw.	Dsg.	Chk.	App.
R0	FOR SUBMISSION	24.09.2024	VS	JV	PS	CHN

CLIENT :-

THE EXECUTIVE ENGINEER, RDWS&S DIVISION
 Rural Drinking Water & Sanitation Department

SUPPORT AGENCY FOR :- SEAN ENGINEERS
 DPR PREPARATION No.36, IVth Cross, APC Layout,
 Thindlu Post, Vidyaranyapura,
 Bangalore-560 097
 Ph: 080-23648988, Mob: 9448355094

PROJECT TITLE:-
 5 TPD MRF Facility at Hebri Gram Panchayat

DRAWING TITLE:-
 5 TPD MRF Facility at Hebri Gram Panchayat
 Primary Shed Structural Details

Date:-	Drw.	Dsg.	Chk.	App.	Scale.	Drawing Status
24.09.2024	VS	MN	PS	CHN	AS SHOWN	FOR SUBMISSION

Project No- DRG.NO: Sheet No-10 OF 10 Rev- Ro